

282377-1 ✓ ACTIVE

Multilock Connector System

TE Internal #: 282377-1

Automotive Terminals, Tab, Mating Tab Width 1.8 mm [.071 in], Tab Thickness .64 mm [.025 in], 22 – 20 AWG Wire Size, Multilock Connector System

[View on TE.com >](#)



Terminals & Splices > Automotive Terminals > MULTILOCK, RECEPTACLE AND TAB

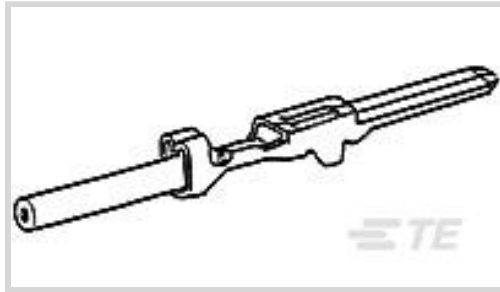

Terminal Type: **Tab**

Mating Tab Width: **1.8 mm [.071 in]**

Mating Tab Thickness: **.64 mm [.025 in]**

Terminal Transmits: **0 – 24 A (Low Power)**

Wire Size: **22 – 20 AWG**

[All MULTILOCK, RECEPTACLE AND TAB \(136\)](#)

Features

Product Type Features

Receptacle Style	180°
Sealable	No
Primary Locking Feature	Clean Body

Contact Features

Contact Size	1.7mm
Contact Fabrication	Stamped & Formed
Wire Contact Termination Area Plating Material	Tin
Typical Current Rating	6 A
Crimp Type	F-Crimp
Terminal Type	Tab
Mating Tab Width	1.8 mm[.071 in]
Mating Tab Thickness	.64 mm[.025 in]
Interface Plating	Tin (Sn)

Termination Features

Termination Method to Wire & Cable	Crimp
Product Terminates To	Wire

Dimensions



Wire Size	.3 – .5 mm ²
Wire Size Search	20 AWG, 21 AWG, 22 AWG

Usage Conditions

Insulation Option	Uninsulated
Operating Temperature (Max)	80 °C, 85 °C, 90 °C, 100 °C, 105 °C [176 °F] [185 °F][194 °F][212 °F][221 °F]
Operating Temperature Range	-30 – 105 °C [-22 – 221 °F]

Operation/Application

Compatible With Wire Base Material	Copper
------------------------------------	--------

Packaging Features

Packaging Quantity	4000
Packaging Method	Reel

Other

Terminal Transmits	0 – 24 A (Low Power)
--------------------	----------------------

Product Compliance

[For compliance documentation, visit the product page on TE.com>](#)

EU RoHS Directive 2011/65/EU	Compliant
EU ELV Directive 2000/53/EC	Compliant
China RoHS 2 Directive MIIT Order No 32, 2016	No Restricted Materials Above Threshold
EU REACH Regulation (EC) No. 1907/2006	Current ECHA Candidate List: JUNE 2023 (235) Candidate List Declared Against: JUNE 2023 (235) Does not contain REACH SVHC
Halogen Content	Low Halogen - Br, Cl, F, I < 900 ppm per homogenous material. Also BFR/CFR/PVC Free
Solder Process Capability	Not applicable for solder process capability

Product Compliance Disclaimer

This information is provided based on reasonable inquiry of our suppliers and represents our current actual knowledge based on the information they provided. This information is subject to change. The part numbers that TE has identified as EU RoHS compliant have a maximum concentration of 0.1% by weight in homogenous materials for lead, hexavalent chromium, mercury, PBB, PBDE, DBP, BBP, DEHP, DIBP, and 0.01% for cadmium, or qualify for an exemption to these limits as defined in the Annexes of Directive 2011/65/EU (RoHS2). Finished electrical and electronic equipment products will be CE marked as required by Directive 2011/65/EU. Components may not be CE marked. Additionally, the part numbers that TE has identified as EU ELV compliant have a maximum concentration of 0.1% by weight in homogenous materials for lead, hexavalent chromium, and mercury, and 0.01% for cadmium, or qualify for an exemption to these limits

as defined in the Annexes of Directive 2000/53/EC (ELV). Regarding the REACH Regulation, the information TE provides on SVHC in articles for this part number is based on the latest European Chemicals Agency (ECHA) 'Guidance on requirements for substances in articles' posted at this URL: <https://echa.europa.eu/guidance-documents/guidance-on-reach>

Compatible Parts



TE Part # 9-1579007-1
EXTRACTION TOOL



TE Part # 2305570-1
Strip Terminal Cutter-Side Feed-No Crimp



TE Part # CAT-M9194-CH8172
MULTILOCK, CONNECTOR HOUSING



TE Part # 2151090-1
OCEAN_2.0_Applicator-S-070F080BX



TE Part # 2151090-2
OCEAN_2.0_Applicator-S-070F080BX



TE Part # 7-2151090-1
OCEAN_2.0_Applicator-S-070F080BX



TE Part # 7-2151090-2
OCEAN_2.0_Applicator-S-070F080BX



TE Part # 7-2151090-7
OCEAN_2.0_SPARE_PART_KIT-070F080BX

Also in the Series | Multilock Connector System



Automotive Connector Caps & Covers (17)



Automotive Connector EMC Shielding (1)

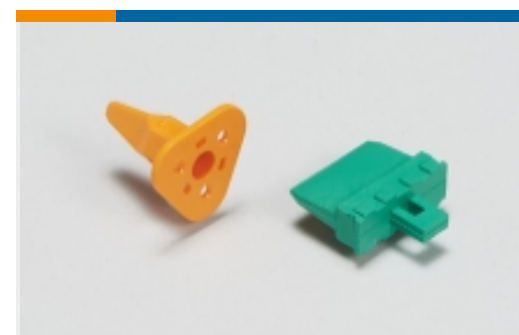

Automotive Connector Locks & Position Assurance(2)



Automotive Housings(603)



Automotive Terminals(141)



Connector Seals & Cavity Plugs(2)



Insertion & Extraction Tools(6)



Other Automotive Connector Accessories(14)



PCB Headers & Receptacles(142)

Customers Also Bought

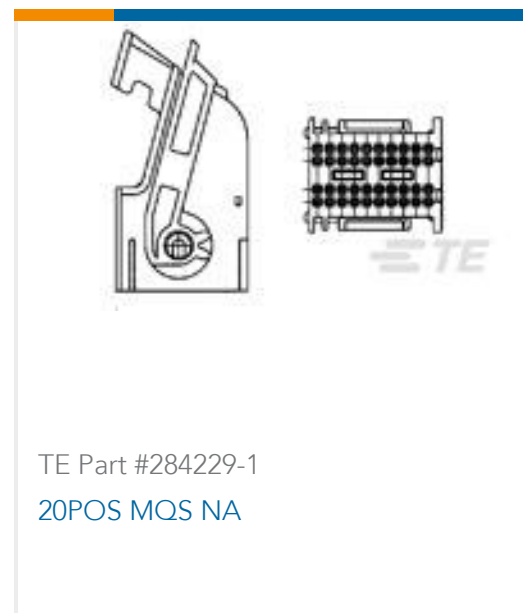
TE Part #2-2176058-4
RLP73N 3A R091 5% 2K RLTE Part #1-2834238-1
3P REC, IP67 R/A T/H CONN,NATURETE Part #3-1625886-0
1W SM M/OX 5% 5R6TE Part #4-1625890-9
2W SM M/OX 5% 3R9TE Part #282370-1
MULTILOCK, CONNECTOR HOUSINGTE Part #284229-1
20POS MQS NATE Part #1599317-1
HSG ASSY 5P REC JPT/SPT HYBRIDTE Part #172507-1
MIC CAP HSG 11P MK II

Documents

Product Drawings

070 MULTILOCK TAB CONTACT

English

CAD Files

Customer View Model

[ENG_CVM_282377-1_A1.3d_igs.zip](#)

English

Customer View Model

[ENG_CVM_282377-1_A1.3d_stp.zip](#)

English

Customer View Model

[ENG_CVM_282377-1_A1.2d_dxf.zip](#)

English

3D PDF

English

By downloading the CAD file I accept and agree to the [Terms and Conditions](#) of use.



Product Specifications

Application Specification

English

APPLICATION SPECIFICATION FOR 070 SR. MULTILOCK* TAB

English

Application Specification

English