

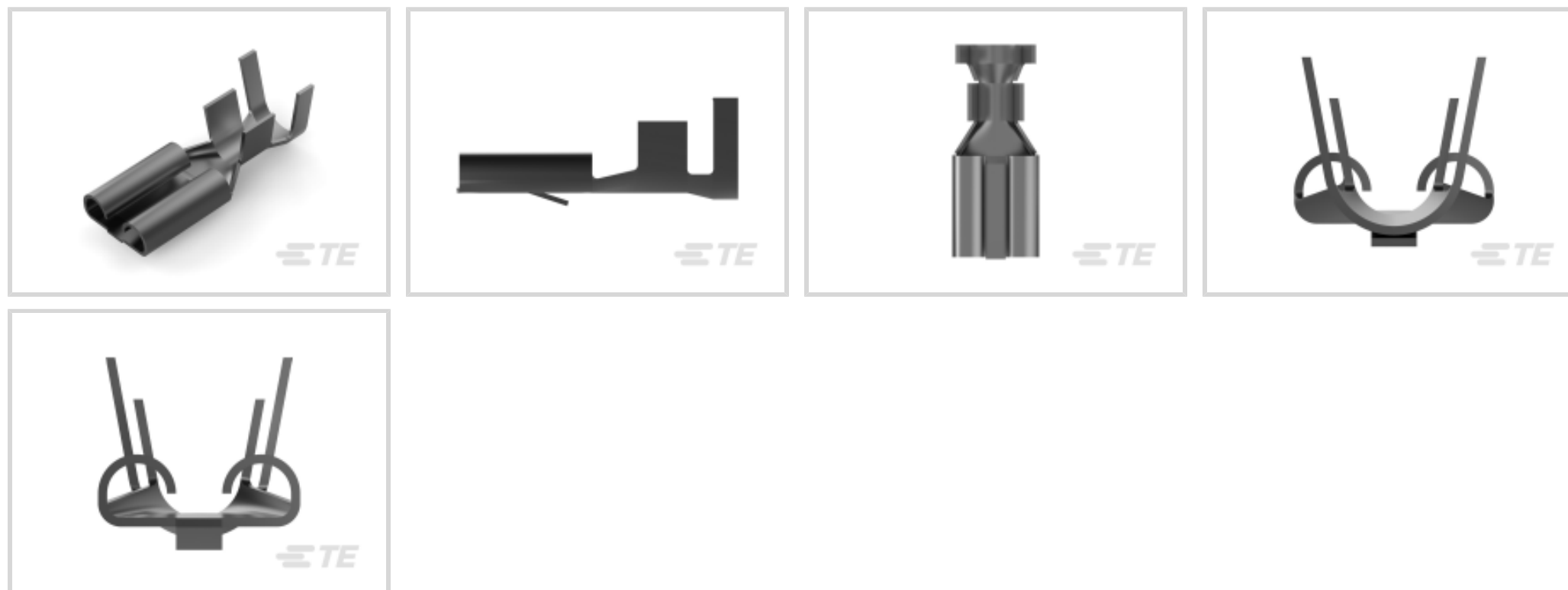

Terminals & Splices > Quick Disconnects



Quick Disconnect Terminal Type: **Receptacle**

Wire Size: **6 – 10 mm²**

Mating Tab Width: **9.53 mm [.375 in]**

Mating Tab Thickness: **1.22 mm [.048 in]**

Features

Product Type Features

Insertion Force	Normal
-----------------	--------

Configuration Features

Connection Capacity	Single
Compatible With Wire & Cable Type	Discrete Wire

Electrical Characteristics

Voltage Rating	250 V
----------------	-------

Contact Features

Quick Disconnect Terminal Type	Receptacle
Mating Tab Width	9.53 mm [.375 in]
Mating Tab Thickness	1.22 mm [.048 in]
Terminal Orientation	Straight
Contact Base Material	Brass
Terminal Plating Material	Tin
Crimp Type	F-Crimp



Barrel Type	Open
-------------	------

Termination Features

Product Terminates To	Wire & Cable
-----------------------	--------------

Mechanical Attachment

Locking Lance Height	1.25 mm
----------------------	---------

Wire Insulation Support	With
-------------------------	------

Mating Retention Type	Locking Lance
-----------------------	---------------

Dimensions

Terminal Material Thickness	.51 mm[.02 in]
-----------------------------	----------------

Product Length	29 mm[1.14 in]
----------------	----------------

Compatible Insulation Diameter Range	5 – 7 mm[.197 – .276 in]
--------------------------------------	--------------------------

Wire Size	6 – 10 mm ²
-----------	------------------------

Usage Conditions

Insulation Option	Uninsulated
-------------------	-------------

Operating Temperature Range	-40 – 110 °C[-40 – 230 °F]
-----------------------------	----------------------------

Industry Standards

UL Flammability Rating	UL 94V-2
------------------------	----------

Packaging Features

Packaging Quantity	1000
--------------------	------

Packaging Method	Strip/Reel
------------------	------------

Other

Terminals & Splices Comment	According to DIN 46340, Part 4
-----------------------------	--------------------------------

Product Compliance

[For compliance documentation, visit the product page on TE.com>](#)

EU RoHS Directive 2011/65/EU	Compliant
------------------------------	-----------

EU ELV Directive 2000/53/EC	Compliant
-----------------------------	-----------

China RoHS 2 Directive MIIT Order No 32, 2016	No Restricted Materials Above Threshold
---	---

EU REACH Regulation (EC) No. 1907/2006	Current ECHA Candidate List: JUNE 2023 (235) Candidate List Declared Against: JUNE 2023 (235) Does not contain REACH SVHC
--	---









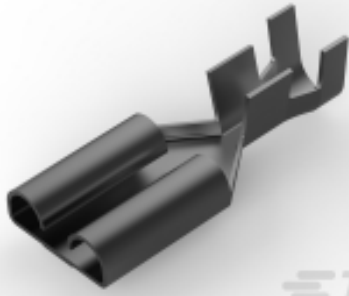

Halogen Content	Low Halogen - Br, Cl, F, I < 900 ppm per homogenous material. Also BFR/CFR/PVC Free
Solder Process Capability	Not applicable for solder process capability

Product Compliance Disclaimer

This information is provided based on reasonable inquiry of our suppliers and represents our current actual knowledge based on the information they provided. This information is subject to change. The part numbers that TE has identified as EU RoHS compliant have a maximum concentration of 0.1% by weight in homogenous materials for lead, hexavalent chromium, mercury, PBB, PBDE, DBP, BBP, DEHP, DIBP, and 0.01% for cadmium, or qualify for an exemption to these limits as defined in the Annexes of Directive 2011/65/EU (RoHS2). Finished electrical and electronic equipment products will be CE marked as required by Directive 2011/65/EU. Components may not be CE marked. Additionally, the part numbers that TE has identified as EU ELV compliant have a maximum concentration of 0.1% by weight in homogenous materials for lead, hexavalent chromium, and mercury, and 0.01% for cadmium, or qualify for an exemption to these limits as defined in the Annexes of Directive 2000/53/EC (ELV). Regarding the REACH Regulation, the information TE provides on SVHC in articles for this part number is based on the latest European Chemicals Agency (ECHA) 'Guidance on requirements for substances in articles' posted at this URL: <https://echa.europa.eu/guidance-documents/guidance-on-reach>

Compatible Parts

 <p>TE Part # 151667-2 FF 375 REC 4-6MM2 TPBR</p>	 <p>TE Part # 280074-2 FF 375 TAB 6-10MM2 PTBR</p>	 <p>TE Part # 170268-2 FF 375 REC 6-10MM2 TPBR</p>	 <p>TE Part # 2150321-2 OCEAN_2.0_Applicator-E-180F300F</p>
 <p>TE Part # 63580-1 FF 125 REC 22-18AWG TPBR</p>	 <p>TE Part # 7-2150321-2 OCEAN_2.0_Applicator-E-180F300F</p>	 <p>KIT REPRESENTATION ONLY</p> <p>TE Part # 7-2150321-7 OCEAN_2.0_SPARE_PART_KIT-180F300F</p>	 <p>TE Part # 880003-4 FF 375 REC 2.5-4.0 MM2 .508X25.65 TPPHBZ</p>
 <p>TE Part # 2-2150321-2 OCEAN_2.0_Applicator-E-180F300F</p>			

Also in the Series | **FASTIN-FASTON 375**



Crimp Terminal Housings(9)



Insertion & Extraction Tools(1)

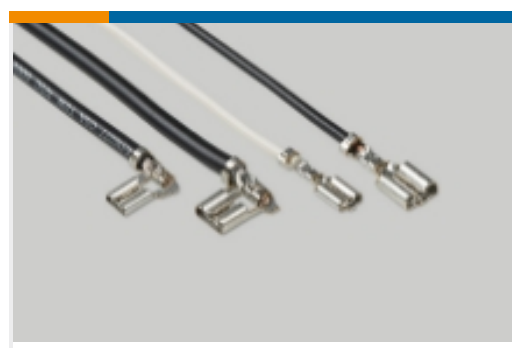

Quick Disconnects(20)

Customers Also Bought

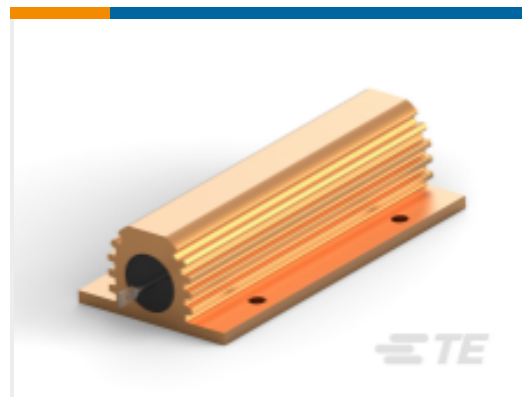
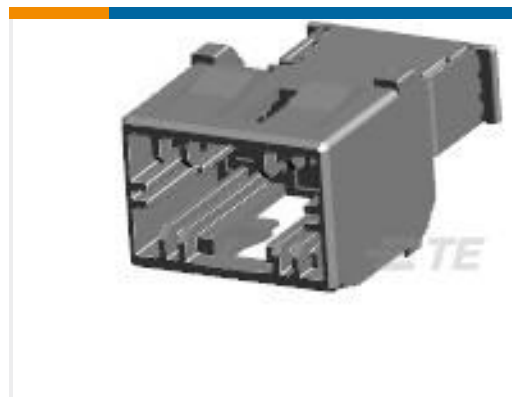
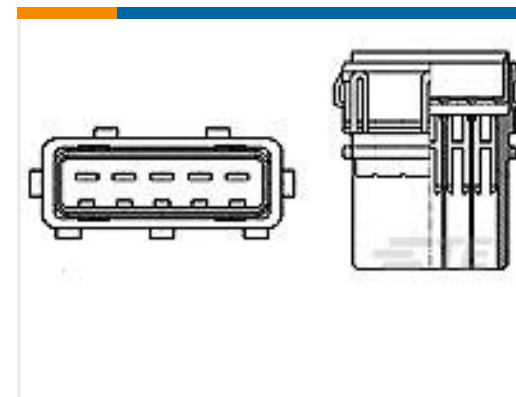
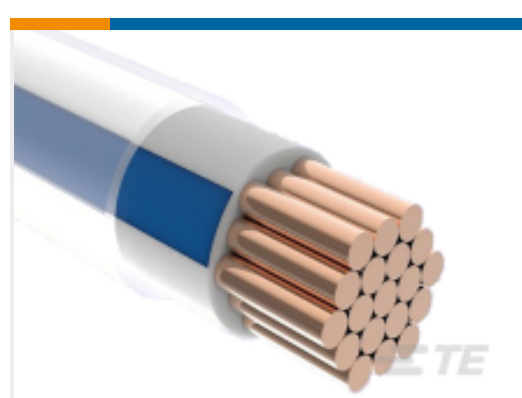
TE Part #3-1630027-9
Power Resistors: Aluminum Housed,
HSCTE Part #1587335-1
BASE ASSEMBLY, 40 POSITIONTE Part #1355290-1
9,5 TAB HOUSING 2POS,BLACKTE Part #444208-1
ASSY 5 POSN JPT TABTE Part #444510-1
HSG 10P COMBINEDTE Part #1-2334415-3
050/110 HYB 36P PLUG ASSY GRYTE Part #1-444314-1
HSG ASSY 9P COMBINEDTE Part #D248123001
ACW0219-0.50-42(NS)TE Part #6137703001
ACW0219-0.50-92(NS)

Documents

Product Drawings

[FF 375 REC 6-10MM2 TPBR](#)

English

CAD Files

[3D PDF](#)

[3D](#)

[Customer View Model](#)

[ENG_CVM_CVM_280755-2_L_c-280755-2-l.2d_dxf.zip](#)



English

Customer View Model

[ENG_CVM_CVM_280755-2_L_c-280755-2-l.3d_igs.zip](#)

English

Customer View Model

[ENG_CVM_CVM_280755-2_L_c-280755-2-l.3d_stp.zip](#)

English

By downloading the CAD file I accept and agree to the [Terms and Conditions](#) of use.

Datasheets & Catalog Pages

[1654742_HOUSEHOLD_APPLIANCES_RAST5](#)

English

Product Specifications

[FASTIN-FASTON CONN. .110 INCH, .187 INCH, .250 INCH, .375 INCH SRS.](#)

English

[Product Specification](#)

English

[Product Specification](#)

English

[CONNETTORE MODULARE A 4 POSIZIONI PER TELERUTTORE 12V / 50 A](#)

English

Product Environmental Compliance

[Product Compliance](#)

English

[Product Compliance](#)

English