

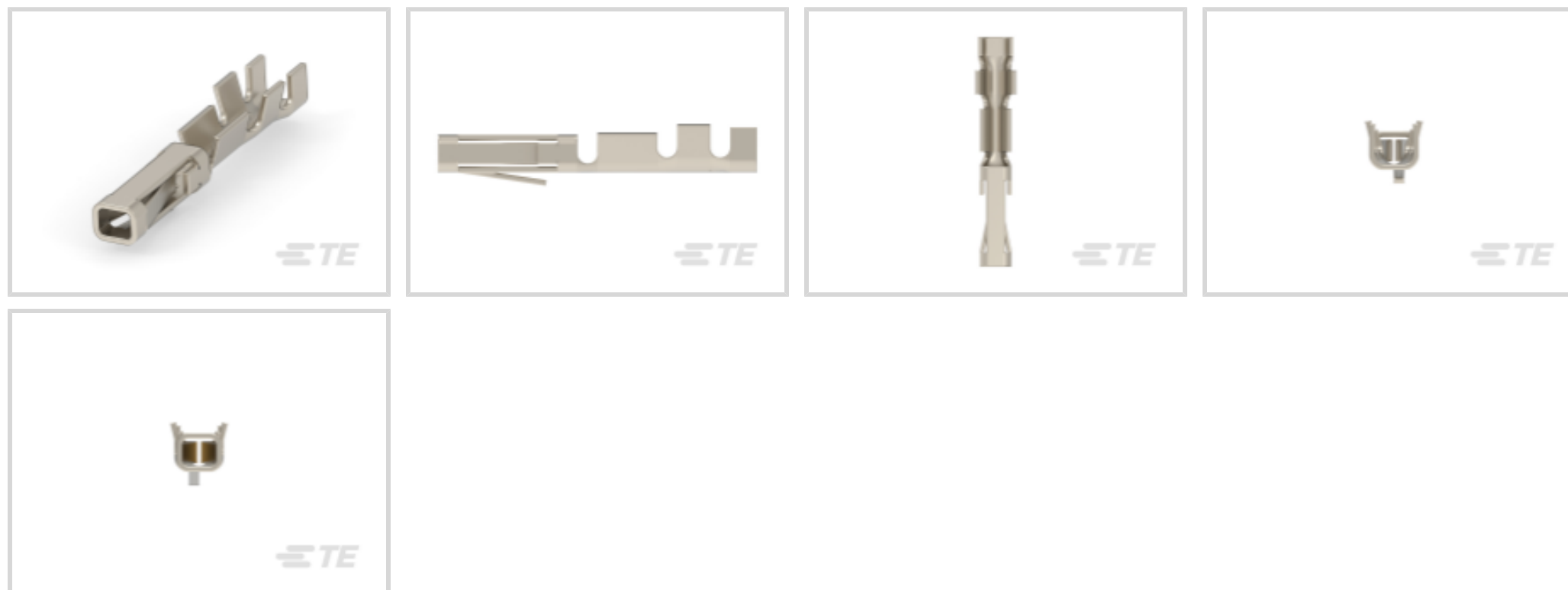

Connectors > PCB Connectors > Wire-to-Board Connectors > Wire-to-Board Connector Contacts



Contact Type: **Socket**

Connector System: **Wire-to-Board**

Wire Size: **.12 – .4 mm<sup>2</sup>**

## Features

### Product Type Features

Applied Pressure	Standard
Connector System	Wire-to-Board
Connector & Contact Terminates To	Wire & Cable

### Configuration Features

Compatible With Wire & Cable Type	Discrete Wire
-----------------------------------	---------------

### Contact Features

Mating Square Post Dimension	.64 mm [.025 in]
	15 μin
Contact Base Material	Phosphor Bronze
Contact Type	Socket
Contact Mating Area Plating Material	Gold
Contact Current Rating (Max)	3 A

### Termination Features

Termination Method to Wire & Cable	Crimp
------------------------------------	-------

### Mechanical Attachment



Wire Insulation Support	With
-------------------------	------

Connector Mounting Type	Cable Mount (Free-Hanging)
-------------------------	----------------------------

### Dimensions

Compatible Insulation Diameter Range	.89 – 1.55 mm [.035 – .061 in]
--------------------------------------	--------------------------------

Wire Size	.12 – .4 mm <sup>2</sup>
-----------	--------------------------

### Usage Conditions

Operating Temperature Range	-40 – 80 °C [-40 – 176 °F]
-----------------------------	----------------------------

### Operation/Application

Circuit Application	Signal
---------------------	--------

### Packaging Features

Packaging Quantity	20000
--------------------	-------

Packaging Method	Reel
------------------	------

### Product Compliance

[For compliance documentation, visit the product page on TE.com>](#)

EU RoHS Directive 2011/65/EU	Compliant
------------------------------	-----------

EU ELV Directive 2000/53/EC	Compliant
-----------------------------	-----------

China RoHS 2 Directive MIIT Order No 32, 2016	No Restricted Materials Above Threshold
---	---

EU REACH Regulation (EC) No. 1907/2006	Current ECHA Candidate List: JUNE 2023 (235) Candidate List Declared Against: JUNE 2022 (224) Does not contain REACH SVHC
--	---

















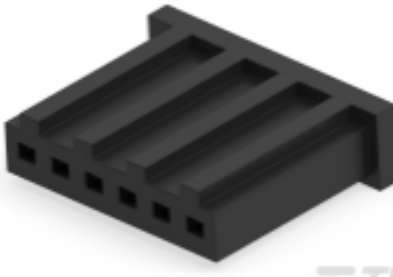

Halogen Content	Low Halogen - Br, Cl, F, I < 900 ppm per homogenous material. Also BFR/CFR/PVC Free
-----------------	---

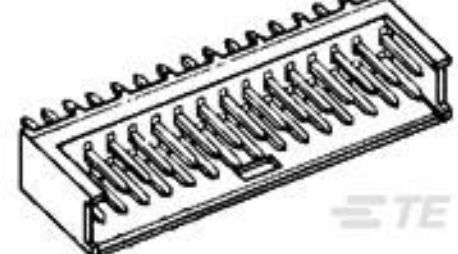
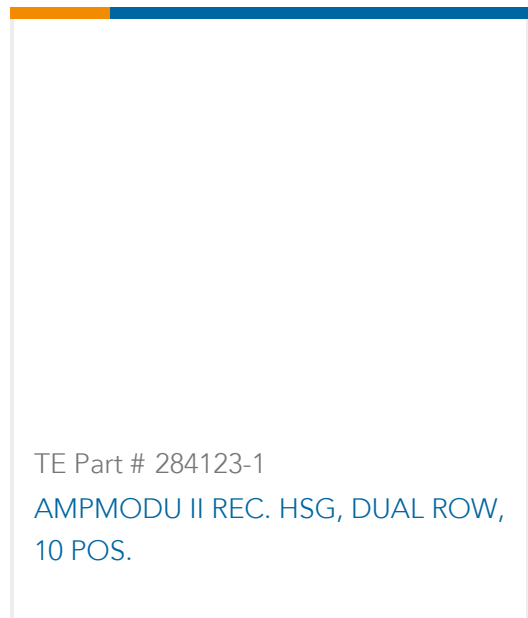
Solder Process Capability	Not applicable for solder process capability
---------------------------	--

#### Product Compliance Disclaimer

This information is provided based on reasonable inquiry of our suppliers and represents our current actual knowledge based on the information they provided. This information is subject to change. The part numbers that TE has identified as EU RoHS compliant have a maximum concentration of 0.1% by weight in homogenous materials for lead, hexavalent chromium, mercury, PBB, PBDE, DBP, BBP, DEHP, DIBP, and 0.01% for cadmium, or qualify for an exemption to these limits as defined in the Annexes of Directive 2011/65/EU (RoHS2). Finished electrical and electronic equipment products will be CE marked as required by Directive 2011/65/EU. Components may not be CE marked. Additionally, the part numbers that TE has identified as EU ELV compliant have a maximum concentration of 0.1% by weight in homogenous materials for lead, hexavalent chromium, and mercury, and 0.01% for cadmium, or qualify for an exemption to these limits as defined in the Annexes of Directive 2000/53/EC (ELV). Regarding the REACH Regulation, the information TE provides on SVHC in articles for this part number is based on the latest European Chemicals Agency (ECHA) 'Guidance on requirements for substances in articles' posted at this URL: <https://echa.europa.eu/guidance-documents/guidance-on-reach>

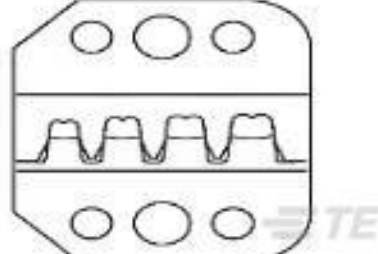
## Compatible Parts

 <p>TE Part # 58535-1 PRO-CRIMPER ASSY MODU MODII</p>	 <p>TE Part # 280514 AMPMODU II REC. HSG, SINGLE ROW, 12 POS.</p>	 <p>TE Part # 280366 AMPMODU II REC. HSG DUAL ROW, 16 POS.</p>	 <p>TE Part # 280365 AMPMODU, DBL ROW, CONTACT REC</p>
 <p>TE Part # 280361 AMPMODU II REC. HSG, SINGLE ROW 8 POS</p>	 <p>TE Part # 280515 AMPMODU II REC. HSG, DUAL ROW, 24 POS.</p>	 <p>TE Part # 280360 AMPMODU II REC. HSG, SINGLE ROW 6 POS</p>	 <p>TE Part # 280513 AMPMODU II REC. HSG, DUAL ROW, 18 POS</p>
 <p>TE Part # 280359 AMPMODU II REC. HSG, SINGLE ROW, 4 POS.</p>	 <p>TE Part # 280368 AMPMODU II REC. HSG, DUAL ROW, 30 POS.</p>	 <p>TE Part # 280363 AMPMODU II REC. HSG, SINGLE ROW, 15 POS.</p>	 <p>TE Part # 280388-2 2X22P MODU II SHRD HDR,ST, 0.38AU</p>
 <p>TE Part # 284123-1 AMPMODU II REC. HSG, DUAL ROW, 10 POS.</p>	 <p>TE Part # 58654-1 PRO-CRIMP TL &amp; DIE MOD II</p>	 <p>TE Part # 280362 AMPMODU II REC. HSG, SINGLE ROW, 10 POS.</p>	 <p>TE Part # 280358 AMPMODU II REC. HSG, SINGLE ROW 2 POS</p>
 <p>TE Part # 280512 AMPMODU II REC. HSG, SINGLE ROW, 9 POS.</p>	 <p>TE Part # 281018 AMPMODU II REC. HSG, DUAL ROW, 36 POS.</p>	 <p>TE Part # 58535-2 PRO-CRIMPER ASSY MODU</p>	 <p><b>KIT</b> REPRESENTATION ONLY</p> <p>TE Part # 7-2151969-7 OCEAN_2.0_SPARE_PART_KIT-055F062O</p>

## Also in the Series | AMPMODU IV/V



Automotive Housings(2)

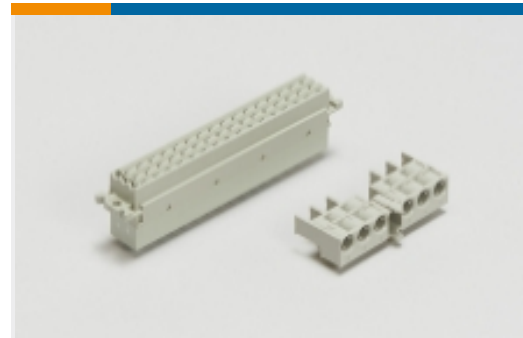

Backplane Connector Housings(1)



Board-to-Board Connector Contacts(6)



Connector Strain Relief(3)



Insertion & Extraction Tools(4)

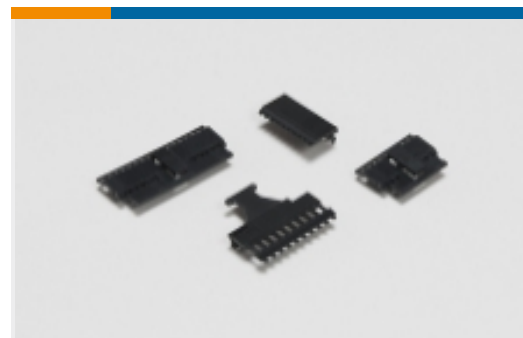

PCB Connector Covers(18)



PCB Connector Keying(6)



PCB Connector Mounting(1)

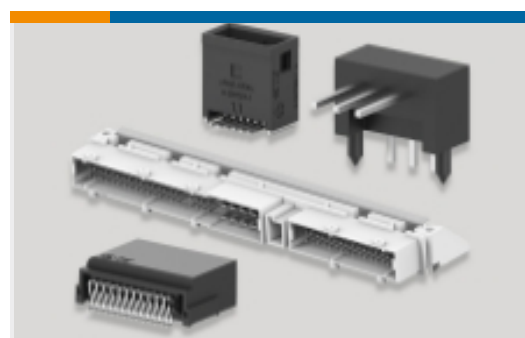

PCB Headers & Receptacles(934)

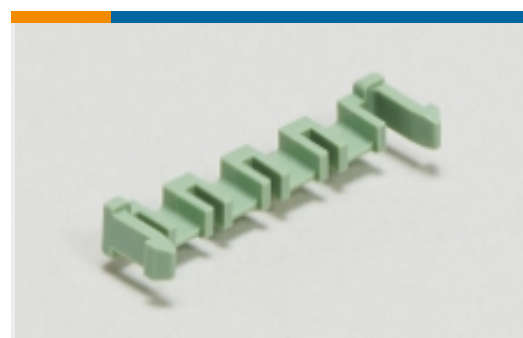

PCB Latches, Locks & Retainers(7)



Rectangular Connector Housings(5)



Standard Rectangular Connectors(8)

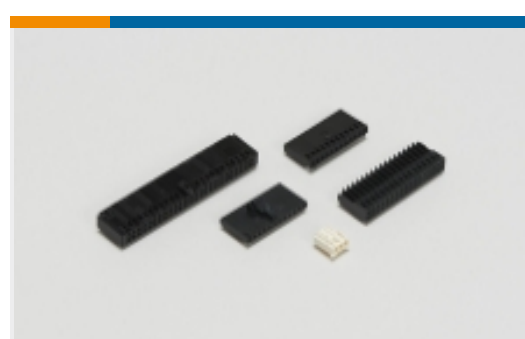

Wire-to-Board Connector Assemblies & Housings(447)



Wire-to-Board Connector Contacts (322)

## Customers Also Bought



TE Part #HDP24-18-21PN  
REC, 21P, BLK, N, 20, P



TE Part #T4132012041-000  
M12,FRONT MOUNT,MALE,A,4P,  
SOLDER WIRE



TE Part #2205076-1  
CA MICRO-MATCH MOW-MOW  
SOLDER WIRE

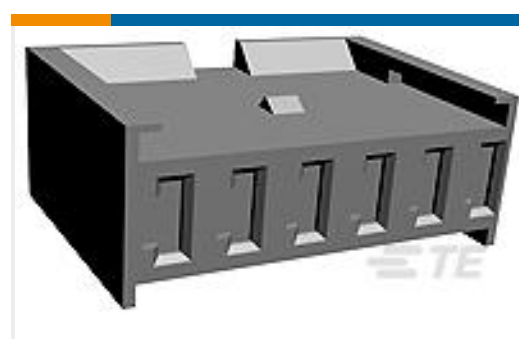

TE Part #280592  
AMPMODU I RECEPTACLE HOUSING,  
20POS

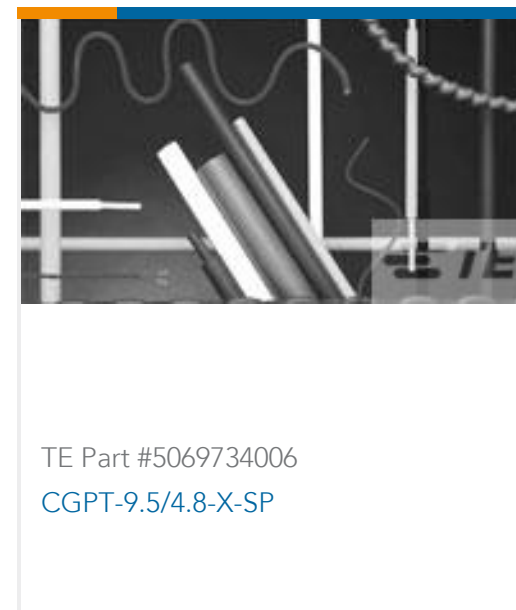
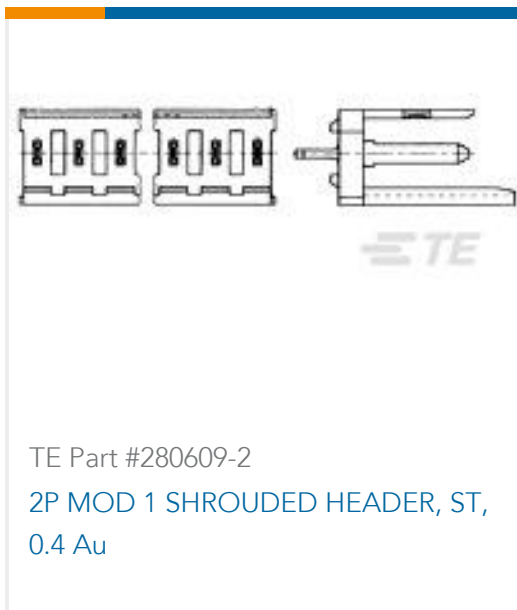

## Documents

### Product Drawings

[MOD II COSI RECP CONT STR PRE](#)

English

### CAD Files

[3D PDF](#)

3D

Customer View Model

[ENG\\_CVM\\_CVM\\_280530-3\\_AN\\_c-280530-3-an.2d\\_dxf.zip](#)

English

Customer View Model

[ENG\\_CVM\\_CVM\\_280530-3\\_AN\\_c-280530-3-an.3d\\_igs.zip](#)

English

Customer View Model

[ENG\\_CVM\\_CVM\\_280530-3\\_AN\\_c-280530-3-an.3d\\_stp.zip](#)

English

By downloading the CAD file I accept and agree to the [Terms and Conditions](#) of use.

### Product Specifications

[Application Specification](#)

English

### Product Environmental Compliance

[TE Material Declaration](#)

English