



[View on TE.com >](#)

Application Tooling > Hand Crimping Tools



Tool Grade: **Commercial Crimp Tooling**
 Die Sets Type: **Removable/Interchangeable**
 Specification Type: **TE Product Specification (114-)**
 TE Certification: **Cannot be Certified**
 Tooling Type: **SDE Crimp Die Set**

Features

Other

Crimp Form-Wire Barrel Type	Open Barrel - F Crimp
Tool Grade	Commercial Crimp Tooling
Die Sets Type	Removable/Interchangeable
Specification Type	TE Product Specification (114-)
TE Certification	Cannot be Certified
Tooling Type	SDE Crimp Die Set

Product Compliance

[For compliance documentation, visit the product page on TE.com>](#)

EU RoHS Directive 2011/65/EU	Out of Scope
EU ELV Directive 2000/53/EC	Out of Scope
China RoHS 2 Directive MIIT Order No 32, 2016	Restricted Materials Above Threshold
EU REACH Regulation (EC) No. 1907/2006	Current ECHA Candidate List: JUNE 2023 (235) Not Yet Reviewed
Halogen Content	Not Low Halogen - contains Br or Cl > 900

ppm.











Solder Process Capability

Not applicable for solder process capability

Product Compliance Disclaimer

This information is provided based on reasonable inquiry of our suppliers and represents our current actual knowledge based on the information they provided. This information is subject to change. The part numbers that TE has identified as EU RoHS compliant have a maximum concentration of 0.1% by weight in homogenous materials for lead, hexavalent chromium, mercury, PBB, PBDE, DBP, BBP, DEHP, DIBP, and 0.01% for cadmium, or qualify for an exemption to these limits as defined in the Annexes of Directive 2011/65/EU (RoHS2). Finished electrical and electronic equipment products will be CE marked as required by Directive 2011/65/EU. Components may not be CE marked. Additionally, the part numbers that TE has identified as EU ELV compliant have a maximum concentration of 0.1% by weight in homogenous materials for lead, hexavalent chromium, and mercury, and 0.01% for cadmium, or qualify for an exemption to these limits as defined in the Annexes of Directive 2000/53/EC (ELV). Regarding the REACH Regulation, the information TE provides on SVHC in articles for this part number is based on the latest European Chemicals Agency (ECHA) 'Guidance on requirements for substances in articles' posted at this URL: <https://echa.europa.eu/guidance-documents/guidance-on-reach>

Compatible Parts

 <p>TE Part # 770250-1 UMNL II PIN PTPBR LP 20-14</p>	 <p>TE Part # 770251-3 UMNL II SOK PTPPHBZ LP 20-14</p>	 <p>TE Part # 350550-1 UMNL SOK 20-14 PTPBR L/P</p>	 <p>TE Part # 350547-1 UMNL PIN 20-14 PTPBR L/P</p>
 <p>TE Part # 770008-3 UMNL II SOK PTPPHBZ</p>	 <p>TE Part # 770007-1 UMNL II PIN PTPBR</p>	 <p>TE Part # 350218-1 UMNL PIN 20-14 .0126PTPBR</p>	 <p>TE Part # 350536-1 UMNL SOK 20-14 .0126 PTPBR</p>
 <p>TE Part # 770251-4 UMNL II SOK SN/AUNI/PHBZ LP</p>	 <p>TE Part # 2362810-1 SDE CRIMP HAND TOOL FRAME W /O DIES</p>	 <p>TE Part # 2378745-1 SDE F UMNL/MNL 14-20AWG ASSY /O DIES</p>	

Customers Also Bought

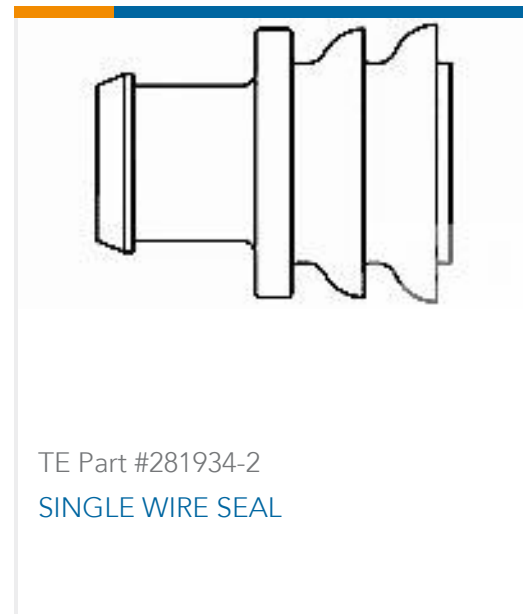

Documents

Datasheets & Catalog Pages

CRIMPING TERMINALS

English

Bottoming Dies

English

SDE Crimp Commercial Tool System

English

Instruction Sheets

Instruction Sheet (U.S.)

English

Instruction Sheet (U.S.)

English