



Connectors > Lighting Connectors > Street Lighting Controls > ANSI Street Lighting Receptacles



Lighting Product Type: **Accessory**

Operating Temperature Range: -40 – 85 °C [-40 – 185 °F]

## Features

### Product Type Features

Lighting Product Type	Accessory
-----------------------	-----------

### Usage Conditions

Operating Temperature Range	-40 – 85 °C [-40 – 185 °F]
-----------------------------	----------------------------

### Industry Standards

Agency/Standard	ANSI
-----------------	------

## Product Compliance

[For compliance documentation, visit the product page on TE.com>](#)

EU RoHS Directive 2011/65/EU	Compliant
EU ELV Directive 2000/53/EC	Compliant
China RoHS 2 Directive MIIT Order No 32, 2016	No Restricted Materials Above Threshold
EU REACH Regulation (EC) No. 1907/2006	Current ECHA Candidate List: JUNE 2023 (235) Candidate List Declared Against: JUNE 2023 (235) SVHC > Threshold: Perfluorobutane sulfonic acid (PFBS) and its salts (.13% in Component Part)

**Article Safe Usage Statements:**







Do not eat, drink or smoke when using this product. Wash thoroughly after handling. Recycle if possible and dispose of the article by following all applicable governmental regulations relevant to your geographic location.

Halogen Content	Low Bromine/Chlorine - Br and Cl < 900 ppm per homogenous material. Also BFR /CFR/PVC Free
Solder Process Capability	Not reviewed for solder process capability

Product Compliance Disclaimer

This information is provided based on reasonable inquiry of our suppliers and represents our current actual knowledge based on the information they provided. This information is subject to change. The part numbers that TE has identified as EU RoHS compliant have a maximum concentration of 0.1% by weight in homogenous materials for lead, hexavalent chromium, mercury, PBB, PBDE, DBP, BBP, DEHP, DIBP, and 0.01% for cadmium, or qualify for an exemption to these limits as defined in the Annexes of Directive 2011/65/EU (RoHS2). Finished electrical and electronic equipment products will be CE marked as required by Directive 2011/65/EU. Components may not be CE marked. Additionally, the part numbers that TE has identified as EU ELV compliant have a maximum concentration of 0.1% by weight in homogenous materials for lead, hexavalent chromium, and mercury, and 0.01% for cadmium, or qualify for an exemption to these limits as defined in the Annexes of Directive 2000/53/EC (ELV). Regarding the REACH Regulation, the information TE provides on SVHC in articles for this part number is based on the latest European Chemicals Agency (ECHA) 'Guidance on requirements for substances in articles' posted at this URL: <https://echa.europa.eu/guidance-documents/guidance-on-reach>

### Compatible Parts

 <p>TE Part # 2359482-1 LUMAWISE ENDURANCE N+ 7P Base With Vent</p>	 <p>TE Part # 2359482-2 LUMAWISE ENDURANCE N+ 7P Base</p>	 <p>TE Part # 2359482-3 LUMAWISE ENDURANCE N+ 5P Base With Vent</p>	 <p>TE Part # 2359482-4 LUMAWISE ENDURANCE N+ 5P Base</p>
 <p>TE Part # 2359482-5 LUMAWISE ENDURANCE N+ 3P Base With Vent</p>	 <p>TE Part # 2359482-6 LUMAWISE ENDURANCE N+ 3P Base</p>		

### Customers Also Bought

 <p>TE Part #206070-8 CABLE CLAMP KIT #17</p>	 <p>TE Part #DT04-2P REC, 2P, GRY, N</p>	 <p>TE Part #DT06-2S PLG, 2P, GRY, N</p>	 <p>TE Part #W2S Wedgelocks: DEUTSCH DT</p>
--	---	---	--

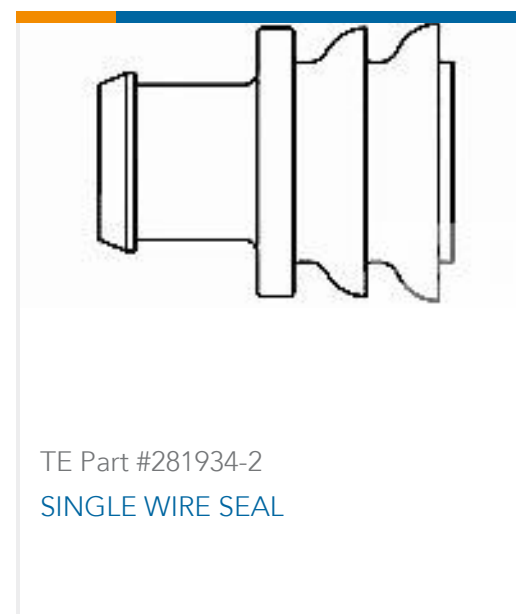

## Documents

### Product Drawings

LUMAWISE ENDURANCE N+ Lt Gray Tall Dome

English

### CAD Files

Customer View Model

[ENG\\_CVM\\_CVM\\_2359615-4\\_A1.3d\\_igs.zip](#)

English

Customer View Model

[ENG\\_CVM\\_CVM\\_2359615-4\\_A1.3d\\_stp.zip](#)

English

Customer View Model

[ENG\\_CVM\\_CVM\\_2359615-4\\_A1.2d\\_dxf.zip](#)

English

### 3D PDF

3D

By downloading the CAD file I accept and agree to the [Terms and Conditions](#) of use.

### Datasheets & Catalog Pages

LUMAWISE ENDURANCE N+ Network Lighting Controls

English

### Product Specifications

Application Specification

English

### Agency Approvals

[UL\\_CERT\\_CB\\_4789600659\\_TR\\_C1](#)

English

[UL\\_CERT\\_CB\\_US\\_37285\\_C1](#)

English