

2329912-1 ✓ ACTIVE



[Power Versa-Lock](#) | [Power Versa-Lock 5.0](#)

TE Internal #: 2329912-1

Power Contacts, Contact, 600 VAC, 600 VDC, Tin, 20 – 18 AWG

Wire Size, .5 – .8 mm² Wire Size, Wire & Cable, Crimp, Power,

Power Versa-Lock 5.0

[View on TE.com >](#)

Connectors > Power Connectors > Power Contacts

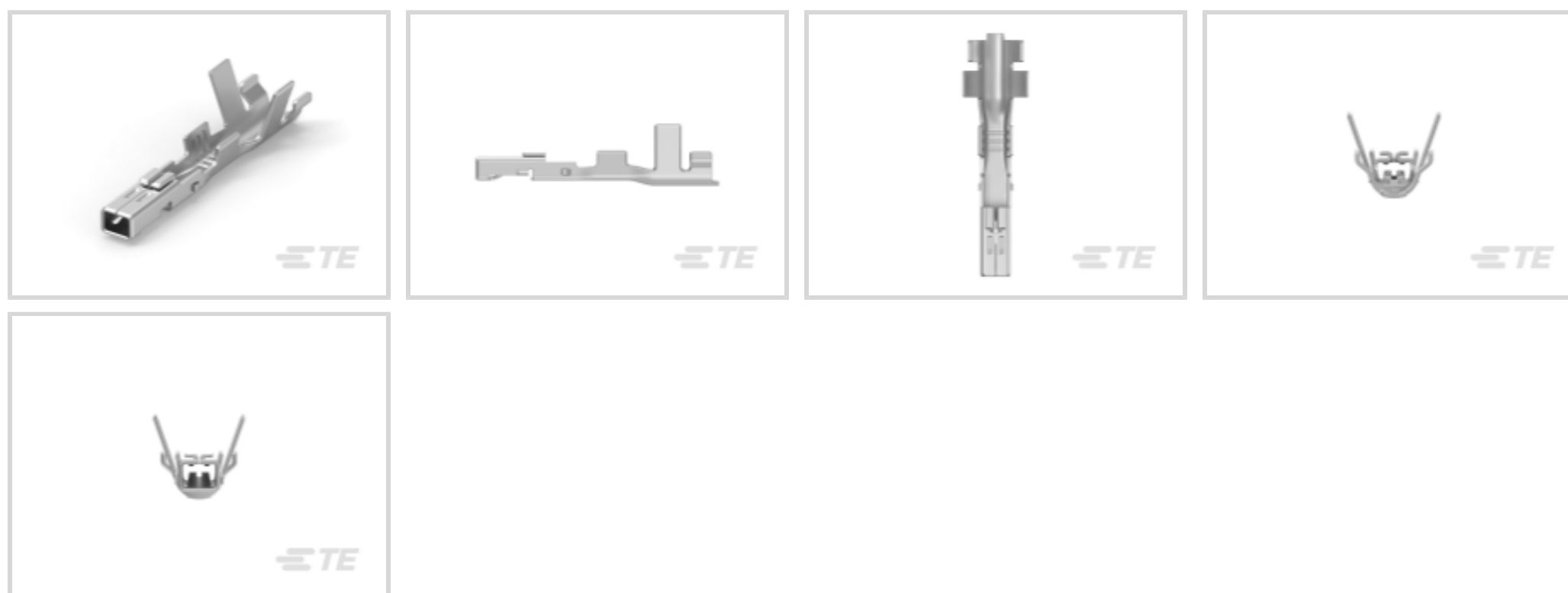

Power Contact Type: **Contact**

Operating Voltage: **600 VDC**

Contact Mating Area Plating Material: **Tin**

Wire Size: **20 – 18 AWG**

Features

Product Type Features

Compatible With Discrete Wire Type	Stranded
Power Contact Type	Contact
Sealable	No
Connector & Contact Terminates To	Wire & Cable

Electrical Characteristics

Operating Voltage	600 VDC
-------------------	---------

Contact Features

Contact Mating Area Plating Material	Tin
Contact Current Rating (Max)	8 A
Contact Type	Receptacle
Contact Retention Within Housing	Without
Mating Tab Width	1.5 mm[.06 in]
Mating Tab Thickness	.5 mm[.02 in]
Contact Base Material	Copper Alloy
Wire Contact Termination Area Plating Material	Pre-Tin



Wire Contact Termination Area Plating Material Finish	Matte
Contact Orientation	Straight

Termination Features

Termination Method to Wire & Cable	Crimp
------------------------------------	-------

Mechanical Attachment

Carrier Strip Mount Orientation	Side Feed
Wire Insulation Support	With

Dimensions

Wire Size	.5 – .8 mm ²
Compatible Insulation Diameter Range	1.6 – 2.3 mm, 1.7 – 2.7 mm [.063 – .091 in] [.067 – .106 in]

Usage Conditions

Operating Temperature Range	-30 – 105 °C [-22 – 221 °F]
-----------------------------	-----------------------------

Operation/Application

Circuit Application	Power
---------------------	-------

Packaging Features

Packaging Method	Reel
------------------	------

Product Compliance

[For compliance documentation, visit the product page on TE.com>](#)

EU RoHS Directive 2011/65/EU	Compliant
EU ELV Directive 2000/53/EC	Compliant
China RoHS 2 Directive MIIT Order No 32, 2016	No Restricted Materials Above Threshold
EU REACH Regulation (EC) No. 1907/2006	Current ECHA Candidate List: JUNE 2023 (235) Candidate List Declared Against: JUNE 2023 (235) Does not contain REACH SVHC
Halogen Content	Low Halogen - Br, Cl, F, I < 900 ppm per homogenous material. Also BFR/CFR/PVC Free
Solder Process Capability	Not reviewed for solder process capability

Product Compliance Disclaimer

This information is provided based on reasonable inquiry of our suppliers and represents our current actual knowledge based on the information they provided. This information is subject to change. The part numbers that TE has identified as EU RoHS compliant have a maximum concentration of 0.1% by weight in homogenous materials for lead, hexavalent chromium, mercury, PBB, PBDE, DBP, BBP, DEHP, DIBP, and 0.01% for cadmium, or qualify for an exemption to these limits as defined in the Annexes of Directive 2011/65/EU (RoHS2). Finished electrical and electronic equipment products will be CE marked as required by Directive 2011/65/EU. Components may not be CE marked. Additionally, the part numbers that TE has identified as EU ELV compliant have a maximum concentration of 0.1% by weight in homogenous materials for lead, hexavalent chromium, and mercury, and 0.01% for cadmium, or qualify for an exemption to these limits as defined in the Annexes of Directive 2000/53/EC (ELV). Regarding the REACH Regulation, the information TE provides on SVHC in articles for this part number is based on the latest European Chemicals Agency (ECHA) 'Guidance on requirements for substances in articles' posted at this URL: <https://echa.europa.eu/guidance-documents/guidance-on-reach>

Compatible Parts



TE Part # 3-2378159-2
Power Versa-Lock PLUG, 1X2 KEY C



TE Part # 3-2378159-3
Power Versa-Lock PLUG, 1X3 KEY C



TE Part # 4-2378159-2
Power Versa-Lock PLUG, 1X2 KEY D



TE Part # 5-2378159-2
Power Versa-Lock PLUG, 1X2 KEY E



TE Part # 6-2378159-2
Power Versa-Lock PLUG, 1X2 KEY F



TE Part # 7-2378159-2
Power Versa-Lock PLUG, 1X2 KEY G



TE Part # 8-2378159-2
Power Versa-Lock PLUG, 1X2 KEY H



TE Part # 9-2378159-2
Power Versa-Lock PLUG, 1X2 KEY I



TE Part # 1-2378159-4
Power Versa-Lock PLUG, 1X4 KEY A



TE Part # 2-2378159-4
Power Versa-Lock PLUG, 1X4 KEY B



TE Part # 234912-1
EXT TOOL FOR POWER DBL LOK REC



TE Part # 1-2336229-6
Power Versa-Lock PLUG, 2X3 KEY A



TE Part # 1-2345728-1
Power Versa-Lock PLUG, 1X1 KEY A



TE Part # 1-2378159-2
Power Versa-Lock PLUG, 1X2 KEY A



TE Part # 1-2378159-3
Power Versa-Lock PLUG, 1X3 KEY A



TE Part # 1-2381260-1
Power Versa-Lock PLUG, 1X1 KEY A, GWT



Also in the Series | **Power Versa-Lock 5.0**

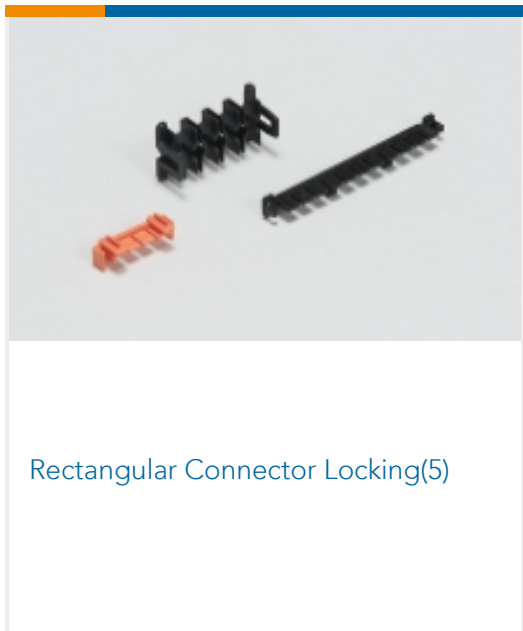
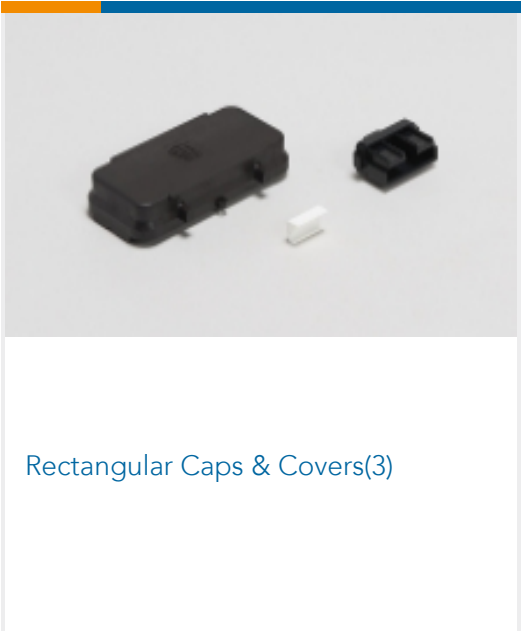
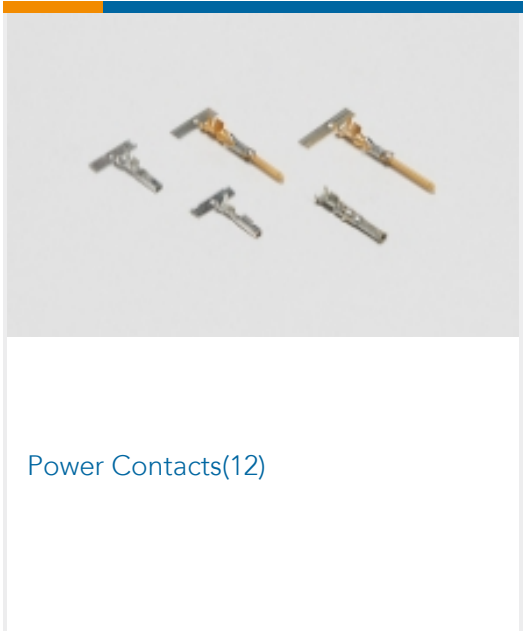
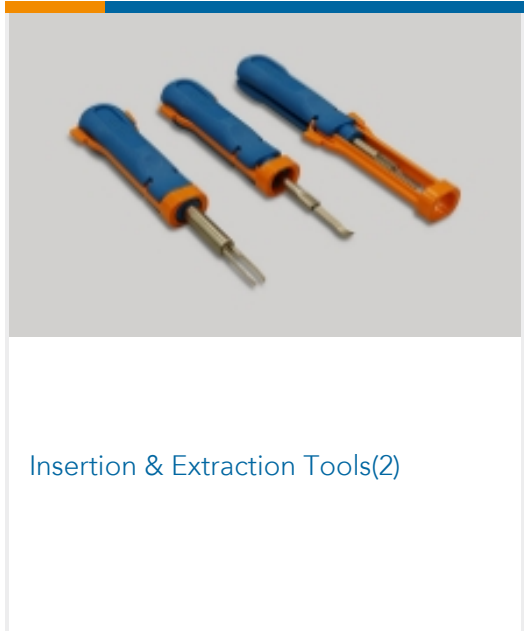
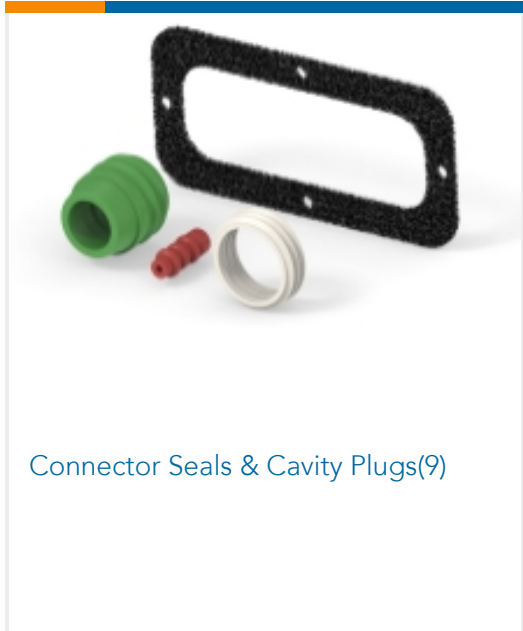

Customers Also Bought



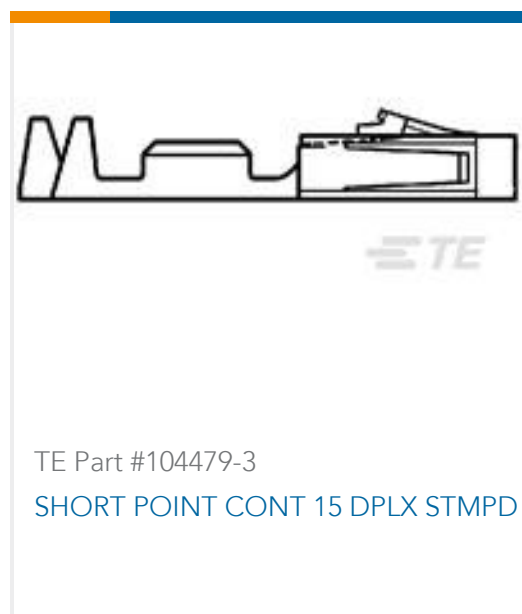

Documents

Product Drawings

[Power Versa-Lock RECPT, 18-20, 2X22 AWG](#)

English

CAD Files

[3D PDF](#)

3D

Customer View Model

[ENG_CVM_CVM_2329912-1_A.2d_dxf.zip](#)

English

Customer View Model

[ENG_CVM_CVM_2329912-1_A.3d_igs.zip](#)

English

Customer View Model

[ENG_CVM_CVM_2329912-1_A.3d_stp.zip](#)

English

By downloading the CAD file I accept and agree to the [Terms and Conditions](#) of use.

Product Specifications

[Application Specification](#)

English

Product Environmental Compliance

[Product Compliance](#)

English

[Product Compliance](#)

English

Instruction Sheets

[Instruction Sheet \(U.S.\)](#)

English