



Alcoswitch | Alcoswitch DIP EDSP

TE Internal #: 2319764-2

DIP & SIP Switches, Switch, Gold Flash, Black Housing, High Temperature Nylon, 4 Switch, -20 – 85 °C, DIP Switch, Alcoswitch

DIP EDSP

[View on TE.com >](#)

Relays, Contactors & Switches > Switches > DIP & SIP Switches

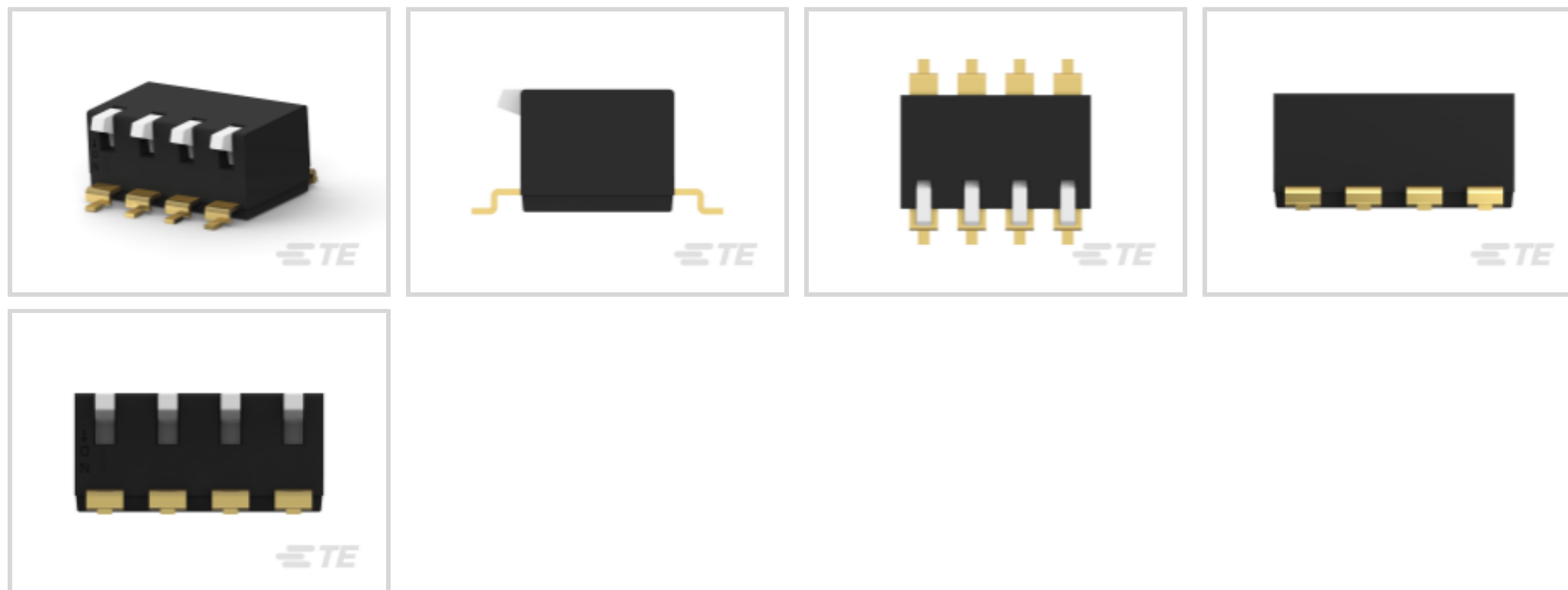

DIP & SIP Switch Product Type: **Switch**

DIP & SIP Switch Contact Mating Area Plating Material: **Gold Flash**

DIP & SIP Switch Housing Color: **Black**

DIP & SIP Switch Housing Material: **High Temperature Nylon**

Sealed DIP & SIP Switch: **No**

Features

Product Type Features

DIP & SIP Switch Product Type	Switch
Sealed DIP & SIP Switch	No
DIP & SIP Switch Type	DIP Switch
Actuator Style	Piano (Side Actuated)

Configuration Features

Number of Positions	4
Number of Switches	4
Configuration (Pole-Throw)	Single Pole - Single Throw

Electrical Characteristics

DIP & SIP Switch Voltage Rating	24 VDC
---------------------------------	--------

Body Features

Actuator Color	White
----------------	-------

Contact Features

--	--



Solder Tail Contact Plating	Gold Flash over Nickel
Shunt Type	DIP
DIP & SIP Switch Contact Mating Area Plating Material	Gold Flash
DIP & SIP Switch Contact Current Rating	.025 A
Contact Base Material	Copper Alloy

Mechanical Attachment

Mounting Angle	Vertical
DIP & SIP Switch Mounting Type	Surface Mount

Housing Features

DIP & SIP Switch Housing Color	Black
DIP & SIP Switch Housing Material	High Temperature Nylon
DIP & SIP Switch Centerline	2.54 mm[.1 in]

Dimensions

Length	10.06 mm[.4 in]
Height	5 mm[.197 in]

Usage Conditions

Operating Temperature Range	-20 – 85 °C
-----------------------------	-------------

Packaging Features

Packaging Method	Tube
Packaging Quantity	47

Product Compliance



[For compliance documentation, visit the product page on TE.com>](#)

EU RoHS Directive 2011/65/EU	Compliant
EU ELV Directive 2000/53/EC	Not Yet Reviewed
China RoHS 2 Directive MIIT Order No 32, 2016	No Restricted Materials Above Threshold
EU REACH Regulation (EC) No. 1907/2006	Current ECHA Candidate List: JUNE 2023 (235) Candidate List Declared Against: JUNE 2023 (235) Does not contain REACH SVHC
Halogen Content	Not Low Halogen - contains Br or Cl > 900 ppm.
Solder Process Capability	Not reviewed for solder process capability

Product Compliance Disclaimer

This information is provided based on reasonable inquiry of our suppliers and represents our current actual knowledge based on the information they provided. This information is subject to change. The part numbers that TE has identified as EU RoHS compliant have a maximum concentration of 0.1% by weight in homogenous materials for lead, hexavalent chromium, mercury, PBB, PBDE, DBP, BBP, DEHP, DIBP, and 0.01% for cadmium, or qualify for an exemption to these limits as defined in the Annexes of Directive 2011/65/EU (RoHS2). Finished electrical and electronic equipment products will be CE marked as required by Directive 2011/65/EU. Components may not be CE marked. Additionally, the part numbers that TE has identified as EU ELV compliant have a maximum concentration of 0.1% by weight in homogenous materials for lead, hexavalent chromium, and mercury, and 0.01% for cadmium, or qualify for an exemption to these limits as defined in the Annexes of Directive 2000/53/EC (ELV). Regarding the REACH Regulation, the information TE provides on SVHC in articles for this part number is based on the latest European Chemicals Agency (ECHA) 'Guidance on requirements for substances in articles' posted at this URL: <https://echa.europa.eu/guidance-documents/guidance-on-reach>

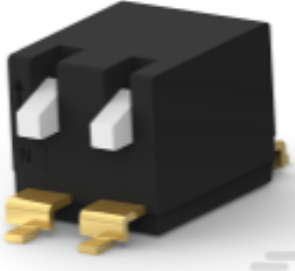
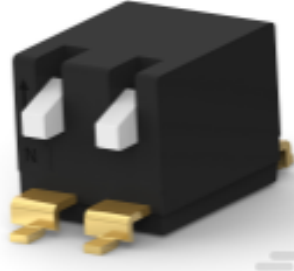
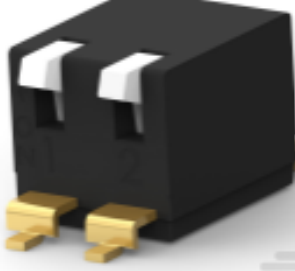
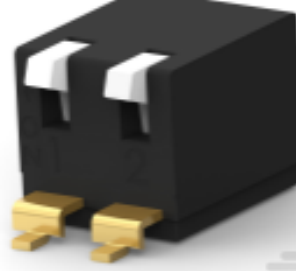
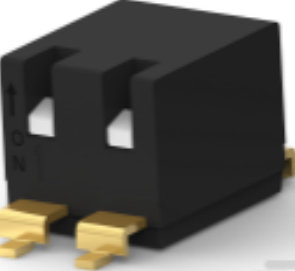
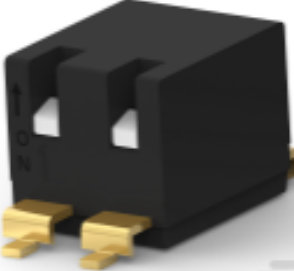
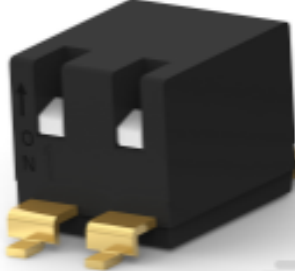
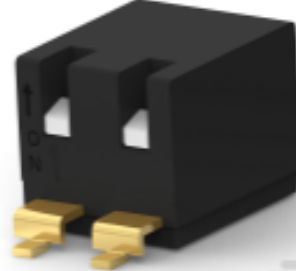
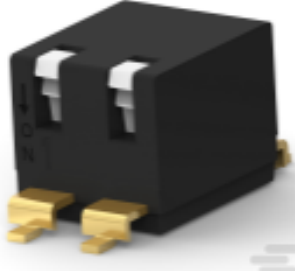
Compatible Parts

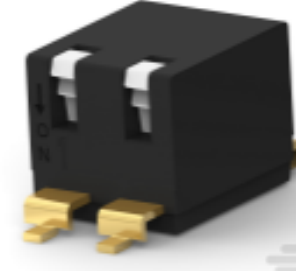
 <p>TE Part # 4-2319764-1 E STACK PIANO 2P G LONG T&R PD OFF</p>	 <p>TE Part # 1-2319764-1 E STACK PIANO 2P G LONG TUBE PD OFF</p>	 <p>TE Part # 3-2319764-1 E STACK PIANO 2P G LONG T&R PD ON</p>	 <p>TE Part # 2319764-1 E STACK PIANO 2P G LONG TUBE PD ON</p>
 <p>TE Part # 4-2319764-6 E STACK PIANO 2P G SHORT T&R PD OFF</p>	 <p>TE Part # 1-2319764-6 E STACK PIANO 2P G SHORT TUBE PD OFF</p>	 <p>TE Part # 5-2319764-6 E STACK PIANO 2P G SHORT SEAL T&R PD OFF</p>	 <p>TE Part # 2-2319764-6 E STACK PIANO 2P G SHORT SEAL TUB PD OFF</p>
 <p>TE Part # 3-2319764-6 E STACK PIANO 2P G SHORT T&R PD ON</p>	 <p>TE Part # 2319764-6 E STACK PIANO 2P G SHORT TUBE PD ON</p>	 <p>TE Part # 5-2319764-1 E STACK PIANO 2P G SHORT SEAL T&R PD ON</p>	 <p>TE Part # 2-2319764-1 E STACK PIANO 2P G SHORT SEAL TUBE PD ON</p>



Also in the Series | **Alcoswitch DIP EDSP**

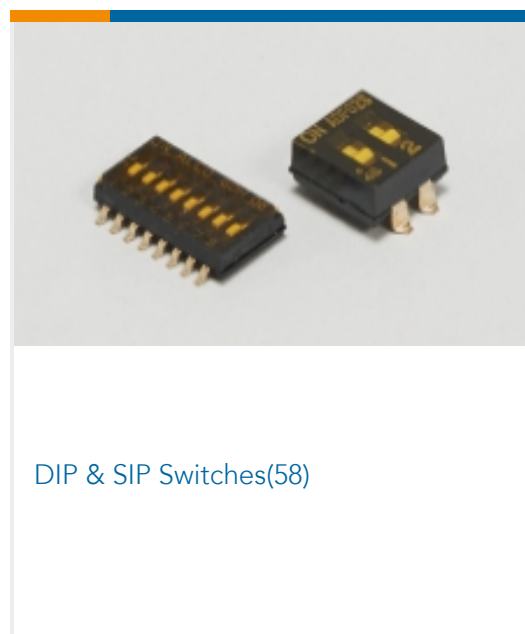

Customers Also Bought

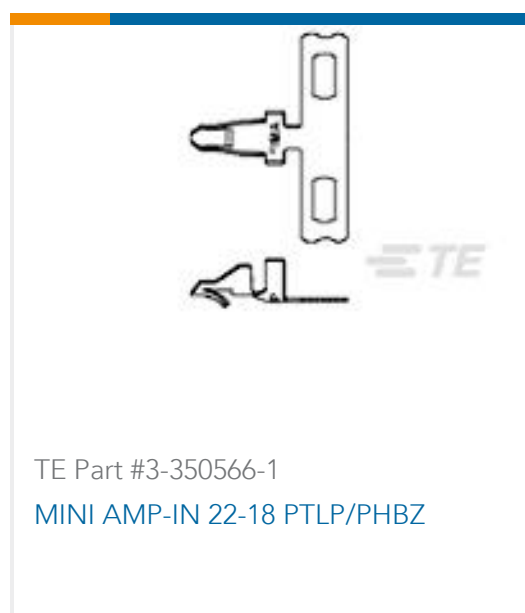

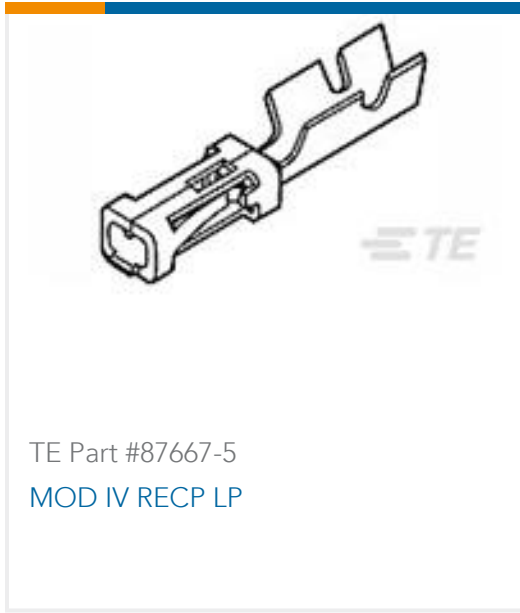

Documents

Product Drawings

[E STACK PIANO 4P G LONG TUBE PD ON](#)

English

CAD Files

[3D PDF](#)

3D

Customer View Model

[ENG_CVM_CVM_2319764-2_A.2d_dxf.zip](#)

English

Customer View Model

[ENG_CVM_CVM_2319764-2_A.3d_igs.zip](#)

English

Customer View Model

[ENG_CVM_CVM_2319764-2_A.3d_stp.zip](#)

English

By downloading the CAD file I accept and agree to the [Terms and Conditions](#) of use.

Datasheets & Catalog Pages

[ALCOSWITCH DIP Swtich EDS,EDSP Series](#)

English