



Sliver for SFF-TA-1002

TE Internal #: 2292069-1

Internal I/O Connectors, TE Sliver, Cable Plug Assembly, Right Angle, Cable-to-Board, 74 Position, Surface Mount, Sliver for SFF-TA-1002

[View on TE.com >](#)

Connectors > PCB Connectors > Internal I/O Connectors

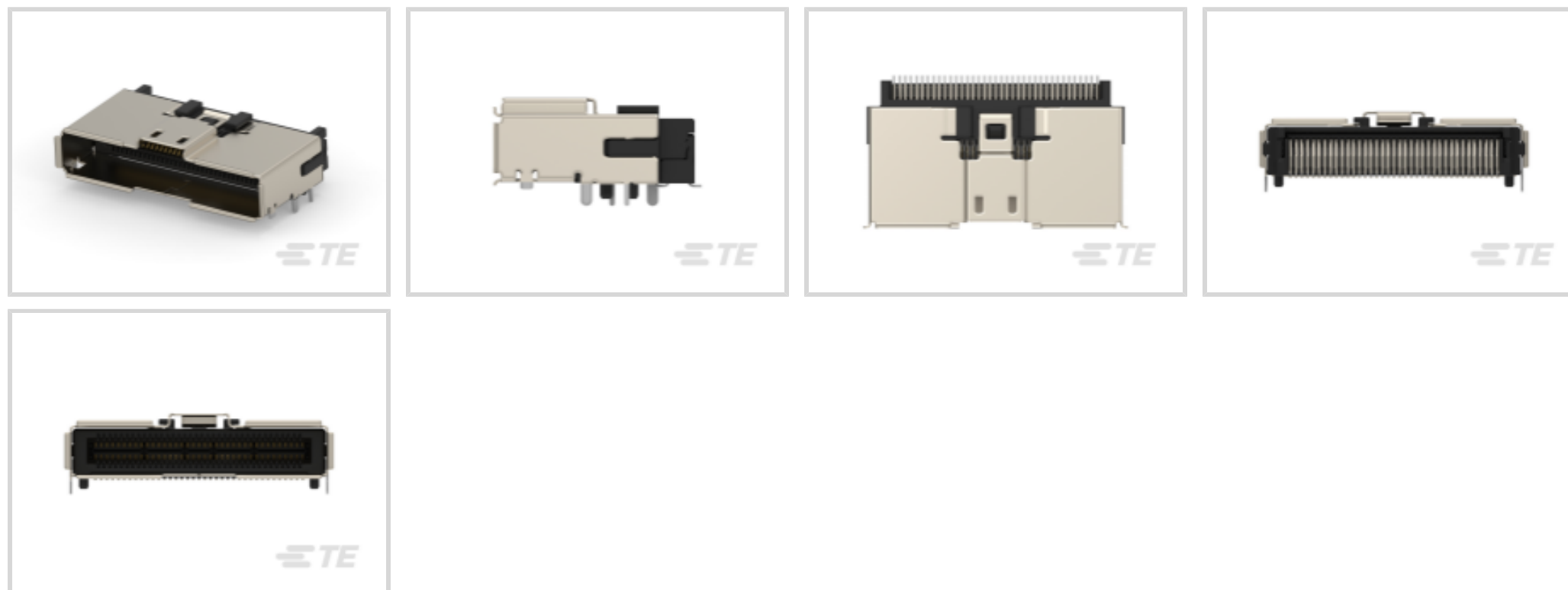

Internal I/O Connector Type: **TE Sliver**

Connector Mates With: **Cable Plug Assembly**

PCB Mount Orientation: **Right Angle**

Connector System: **Cable-to-Board**

Number of Positions: **74**

Features

Product Type Features

Internal I/O Connector Type	TE Sliver
Connector Mates With	Cable Plug Assembly
Connector System	Cable-to-Board
Connector & Contact Terminates To	Printed Circuit Board

Configuration Features

Number of Rows	2
PCB Mount Orientation	Right Angle
Number of Positions	74

Contact Features

Contact Mating Area Plating Material	Gold
Contact Underplating Material	Nickel
PCB Contact Termination Area Plating Material	Tin
Contact Base Material	Copper Alloy
Contact Current Rating (Max)	.9 A



Contact Mating Area Plating Material Thickness	.762 μm [30 μin]
--	---

Termination Features

Termination Method to Printed Circuit Board	Surface Mount
---	---------------

Mechanical Attachment

Connector Mounting Type	Board Mount
-------------------------	-------------

Housing Features

Centerline (Pitch)	.6 mm[.023 in]
--------------------	----------------

Usage Conditions

Operating Temperature Range	-55 – 85 $^{\circ}\text{C}$ [-67 – 185 $^{\circ}\text{F}$]
-----------------------------	---

Operation/Application

Circuit Application	Signal
---------------------	--------

Product Compliance

[For compliance documentation, visit the product page on TE.com>](#)

EU RoHS Directive 2011/65/EU	Compliant
EU ELV Directive 2000/53/EC	Compliant
China RoHS 2 Directive MIIT Order No 32, 2016	No Restricted Materials Above Threshold
EU REACH Regulation (EC) No. 1907/2006	Current ECHA Candidate List: JUNE 2023 (235) Candidate List Declared Against: JUNE 2023 (235) Does not contain REACH SVHC
Halogen Content	Low Halogen - Br, Cl, F, I < 900 ppm per homogenous material. Also BFR/CFR/PVC Free
Solder Process Capability	Reflow solder capable to 260 $^{\circ}\text{C}$

Product Compliance Disclaimer

This information is provided based on reasonable inquiry of our suppliers and represents our current actual knowledge based on the information they provided. This information is subject to change. The part numbers that TE has identified as EU RoHS compliant have a maximum concentration of 0.1% by weight in homogenous materials for lead, hexavalent chromium, mercury, PBB, PBDE, DBP, BBP, DEHP, DIBP, and 0.01% for cadmium, or qualify for an exemption to these limits as defined in the Annexes of Directive 2011/65/EU (RoHS2). Finished electrical and electronic equipment products will be CE marked as required by Directive 2011/65/EU. Components may not be CE marked. Additionally, the part numbers that TE has identified as EU ELV compliant have a maximum concentration of 0.1% by weight in homogenous materials for lead, hexavalent chromium, and mercury, and 0.01% for cadmium, or qualify for an exemption to these limits as defined in the Annexes of Directive 2000/53/EC (ELV). Regarding the REACH Regulation, the information TE provides on SVHC in articles for this part number is based on the latest European Chemicals Agency (ECHA) 'Guidance on requirements for substances in articles' posted at this URL: <https://echa.europa.eu/guidance-documents/guidance-on-reach>



Compatible Parts



TE Part # 2317823-1
CABLE PLUG KIT, SLIVER 74P



TE Part # 2821385-1
SLIVER C/A, 74P, R/A TO R/A, 10GHZ, 85OHM



TE Part # 2821385-2
SLIVER C/A, 74P, R/A TO R/A, 10GHZ, 85OHM



TE Part # 2820396-1
SLIVER C/A, 74P, STR TO STR, 10GHZ, 85OHM



TE Part # 2820396-2
SLIVER C/A, 74P, STR TO STR, 10GHZ, 85OHM



TE Part # 2821376-1
SLIVER C/A, 74P, STR TO STR, 25GHZ, 85OHM



TE Part # 2821376-2
SLIVER C/A, 74P, STR TO STR, 25GHZ, 85OHM



TE Part # 2821639-1
SLIVER C/A, 74P, STR TO R/A, 10GHZ, 85OHM



TE Part # 2821639-2
SLIVER C/A, 74P, STR TO R/A, 10GHZ, 85OHM



TE Part # 2821745-1
SLIVER C/A, 74P, R/A TO R/A, 25GHZ, 85OHM



TE Part # 2821745-2
SLIVER C/A, 74P, R/A TO R/A, 25GHZ, 85OHM



TE Part # 2821746-1
SLIVER C/A, 74P, STR TO R/A, 25GHZ, 85OHM



TE Part # 2821746-2
SLIVER C/A, 74P, STR TO R/A, 25GHZ, 85OHM



TE Part # 2821753-1
SLIVER C/A, 74P, STR TO STR, 10GHZ, 100OHM



TE Part # 2821753-2
SLIVER C/A, 74P, STR TO STR, 10GHZ, 100OHM



TE Part # 2821754-1
SLIVER C/A, 74P, R/A TO R/A, 10GHZ, 100OHM



TE Part # 2821754-2
SLIVER C/A, 74P, R/A TO R/A, 10GHZ, 100OHM



TE Part # 2821755-1
SLIVER C/A, 74P, STR TO R/A, 10GHZ, 100OHM



TE Part # 2821755-2
SLIVER C/A, 74P, STR TO R/A, 10GHZ, 100OHM



TE Part # 2821756-1
SLIVER C/A, 74P, STR TO STR, 25GHZ, 100OHM

Also in the Series | [Sliver for SFF-TA-1002](#)

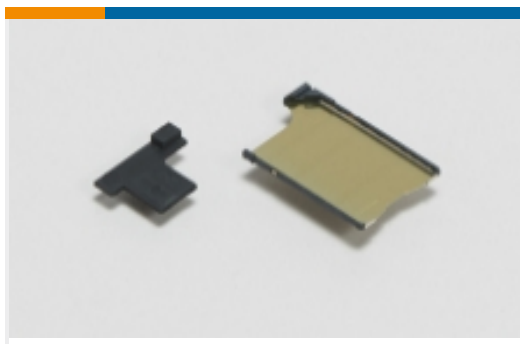

Card Guide Hardware(1)

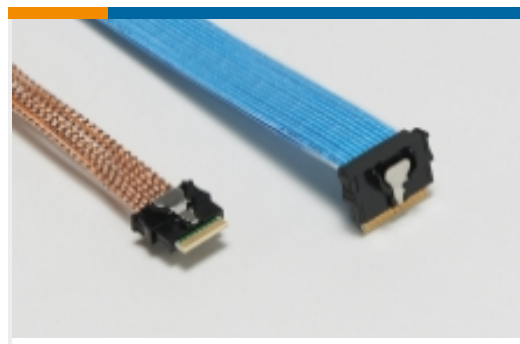

Internal I/O Cable Assemblies(109)



Internal I/O Connectors(135)

Customers Also Bought

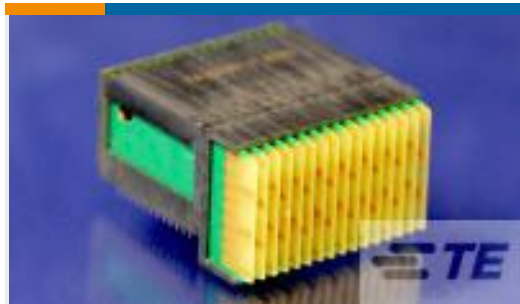

TE Part #1410968-3
MULTIGIG RT2 7RW RTM DC DF CT



TE Part #1410188-3
MULTIGIG RT T2 7RW DC DF F-RGT



TE Part #1871058-4
PCI EXPRESS CONN. EON TYPE, 16

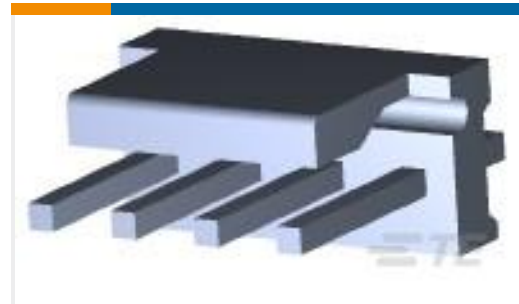

TE Part #3-641208-4
04P MTA156 HDR ASSY FL ST 30AU

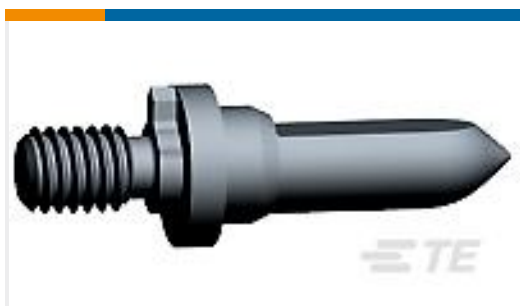

TE Part #2000676-7
Keyed Guide Pin, Machined

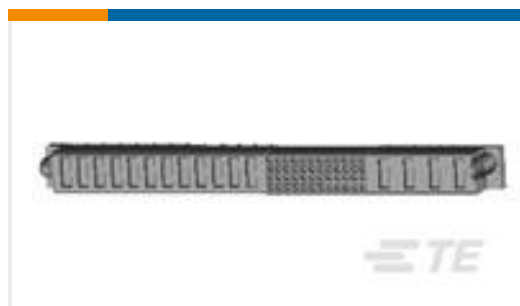

TE Part #6450863-5
MBXLE VERT RCPT 7ACP



TE Part #1-1469373-1
ATCA GUIDE MODULE RA FEMALE

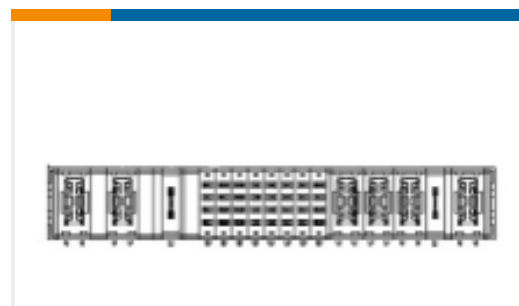

TE Part #2309390-2
VERT RECPT, MULTI-BEAM XLE, VITA 62

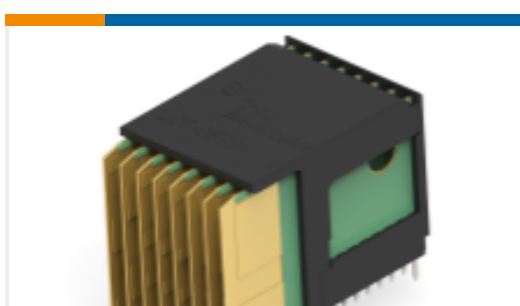

TE Part #2226996-1
DC, 7ROW, P0, TRUE HALF, MULTIGIG RT 2-R

Documents

Product Drawings

[RCPT ASSEMBLY SMT RA 74 POSN MBC](#)

English

CAD Files

[3D PDF](#)

[3D](#)

Customer View Model

[ENG_CVM_CVM_2292069-1_C.2d_dxf.zip](#)



English

Customer View Model

[ENG_CVM_CVM_2292069-1_C.3d_igs.zip](#)

English

Customer View Model

[ENG_CVM_CVM_2292069-1_C.3d_stp.zip](#)

English

By downloading the CAD file I accept and agree to the [Terms and Conditions](#) of use.

Datasheets & Catalog Pages

[Sliver Internal Cabled Interconnect Solutions Brochure \(Chinese\)](#)

Product Environmental Compliance

[MD_2292069-1_09192017646_dmtec](#)

English

[MD_2292069-1_09192017646_dmtec](#)

English

Agency Approvals

[UL Report](#)

English