



All DEUTSCH DTM Housings (109)

Product Compliance

[For compliance documentation, visit the product page on TE.com>](#)

EU RoHS Directive 2011/65/EU	Compliant
EU ELV Directive 2000/53/EC	Compliant
China RoHS 2 Directive MIIT Order No 32, 2016	No Restricted Materials Above Threshold
EU REACH Regulation (EC) No. 1907/2006	Current ECHA Candidate List: JUNE 2023 (235) Candidate List Declared Against: JUNE 2023 (235) SVHC > Threshold: Octamethylcyclotetrasiloxane (D4) (.5% in Component Part) Dodecamethylcyclohexasiloxane (D6) (.5% in Component Part) Decamethylcyclopentasiloxane (D5) (.5% in Component Part) Article Safe Usage Statements: Wash thoroughly after handling. Recycle if possible and dispose of the article by following all applicable governmental regulations relevant to your geographic location.
Halogen Content	Not Low Halogen - contains Br or Cl > 900 ppm.
Solder Process Capability	Not applicable for solder process capability

Product Compliance Disclaimer

This information is provided based on reasonable inquiry of our suppliers and represents our current actual knowledge based on the information they provided. This information is subject to change. The part numbers that TE has identified as EU RoHS compliant have a maximum concentration of 0.1% by weight in homogenous materials for lead, hexavalent chromium, mercury, PBB, PBDE, DBP, BBP, DEHP, DIBP, and 0.01% for cadmium, or qualify for an exemption to these limits as defined in the Annexes of Directive 2011/65/EU (RoHS2). Finished electrical and electronic equipment products will be CE marked as required by Directive 2011/65/EU. Components may not be CE marked. Additionally, the part numbers that TE has identified as EU ELV compliant have a maximum concentration of 0.1% by weight in homogenous materials for lead, hexavalent chromium, and mercury, and 0.01% for cadmium, or qualify for an exemption to these limits as defined in the Annexes of Directive 2000/53/EC (ELV). Regarding the REACH Regulation, the information TE provides on SVHC in articles for this part number is based on the latest European Chemicals Agency (ECHA) 'Guidance on requirements for substances in articles' posted at this URL: <https://echa.europa.eu/guidance-documents/guidance-on-reach>

Compatible Parts



TE Part # CAT-D48-SP729
DEUTSCH Sealing Plugs



TE Part # 1062-20-0322
SOC, SF, SIZE 20, 16-22, SLEVLSS, NI /NI



TE Part # 1062-20-0377
SOC, SF, SIZE 20, 16-22, SLEVLSS, SN /SN



TE Part # 1062-20-0177
SOC, SF, SIZE 20, 16-22, SN/SN



TE Part # 1062-20-0277
SOC, SF, SIZE 20, 16-22, SN/SN



TE Part # 1062-20-0344
SOC, SF, SIZE 20, 16-22, SLEVLSS, AU /SN



TE Part # WM-8S
WEDGE LOCK, 8P, PLG, ORG, DTM



TE Part # DT-RT1
EXT TOOL, FRONT RELEASE



TE Part # 1062-20-0622
SOC, SF, SIZE 20, 14-16, NI/NI



TE Part # 1062-20-0244
SOC, SF, SIZE 20, 16-22, AU/SN



TE Part # 1062-20-0222
SOC, SF, SIZE 20, 16-22, NI/NI



TE Part # 1062-20-0122
SOC, SF, SIZE 20, 16-22, NI/NI



TE Part # 1062-20-0144
SOC, SF, SIZE 20, 16-22, AU/SN



TE Part # 1062-20-0644
SOC, SF, SIZE 20, 14-16, AU/SN



TE Part # 1062-20-0677
SOC, SF, SIZE 20, 14-16, SN/SN

Also in the Series | DEUTSCH DT

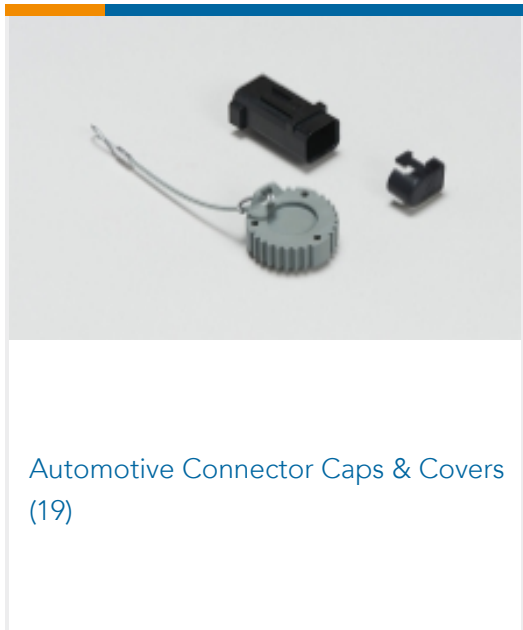

Automotive Connector Caps & Covers
(19)

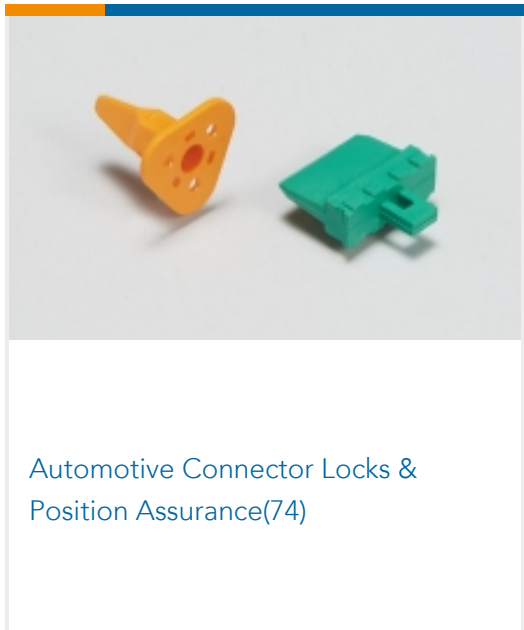

Automotive Connector Locks & Position Assurance(74)

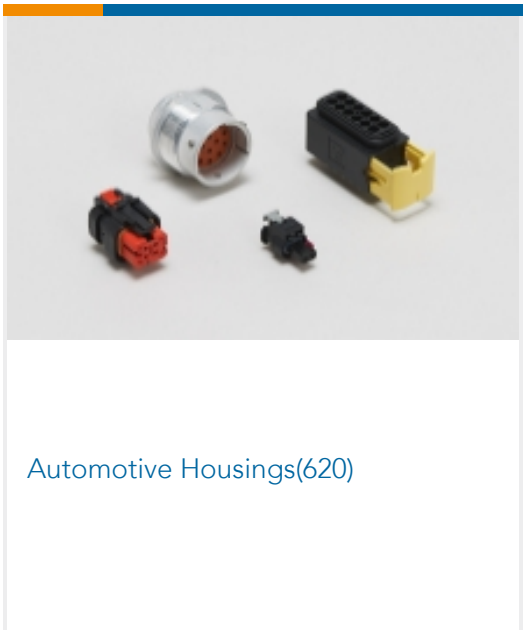

Automotive Housings(620)

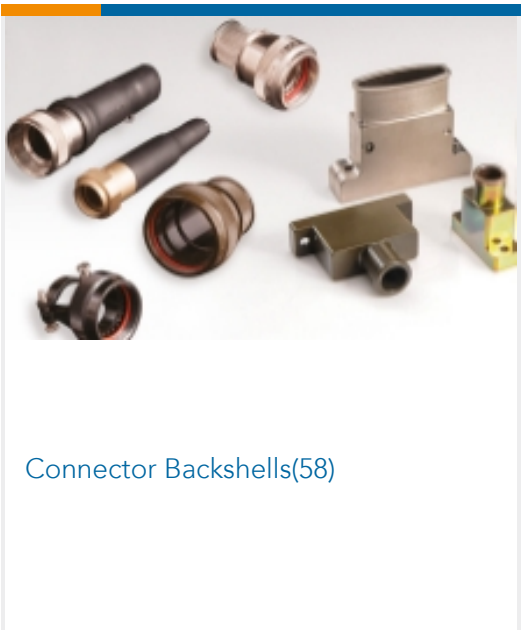

Connector Backshells(58)

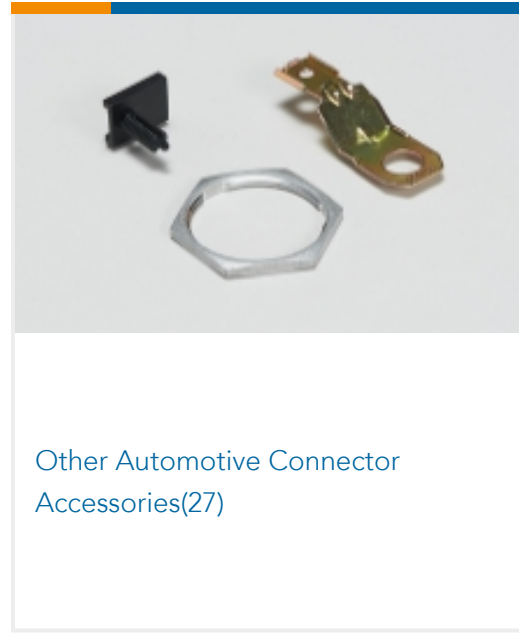
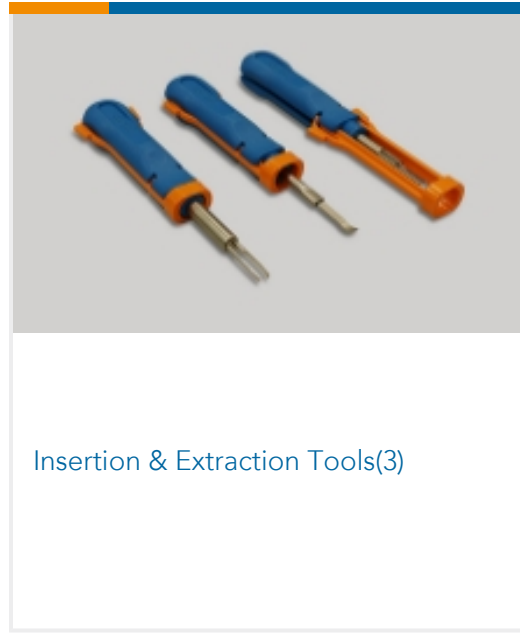
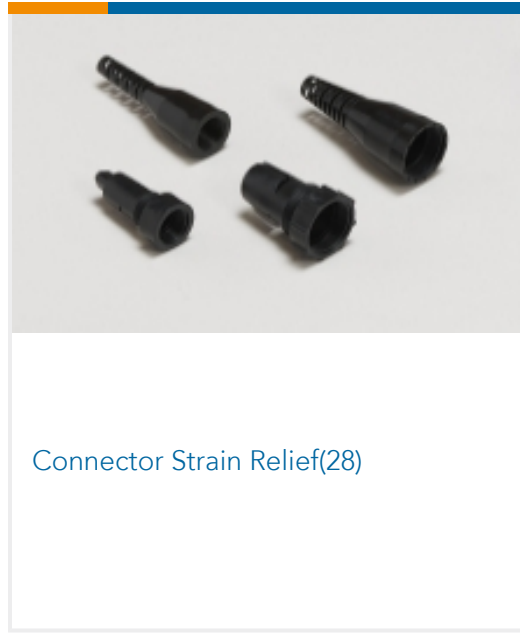
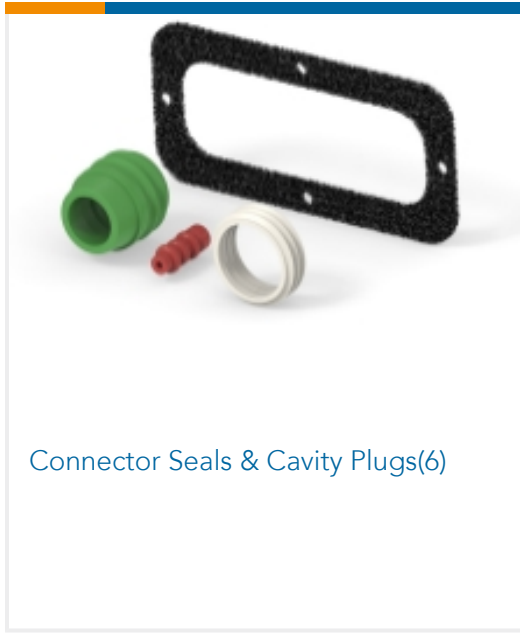

Also in the Series | DEUTSCH DTM

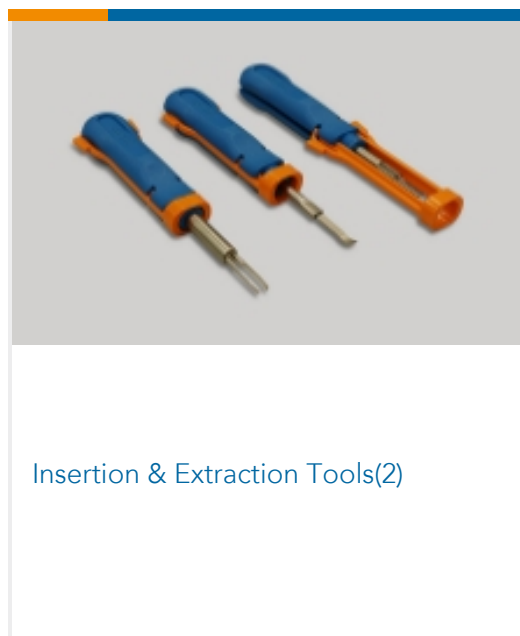
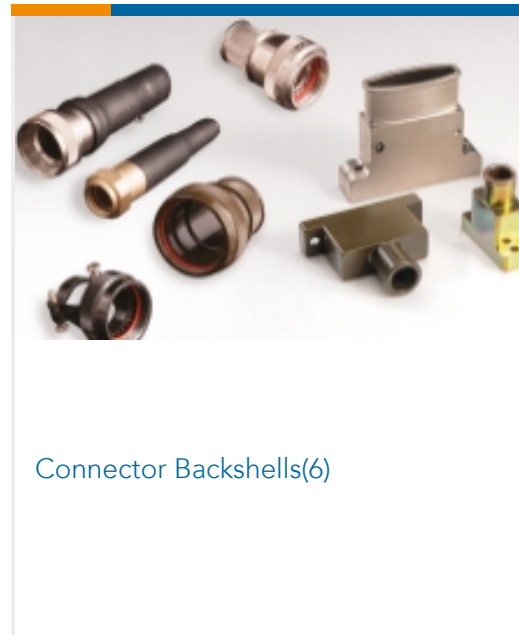
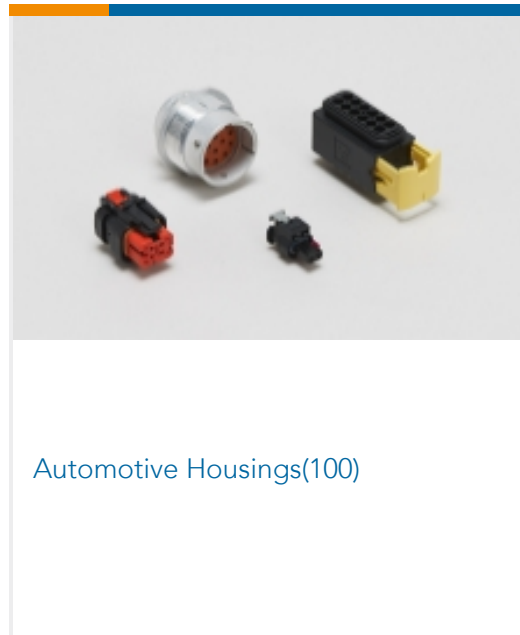
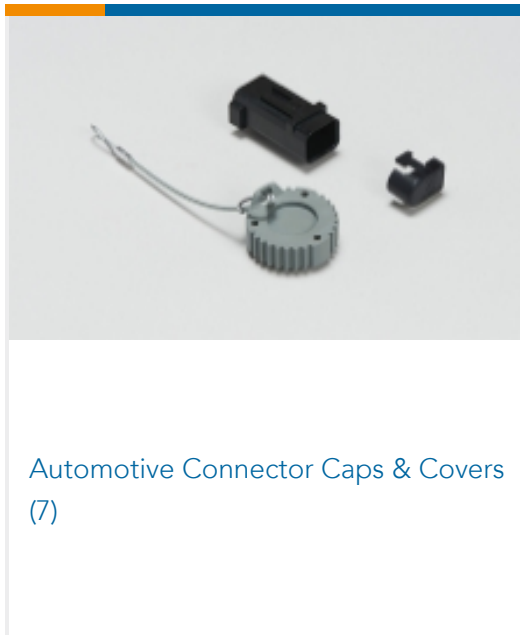

Customers Also Bought

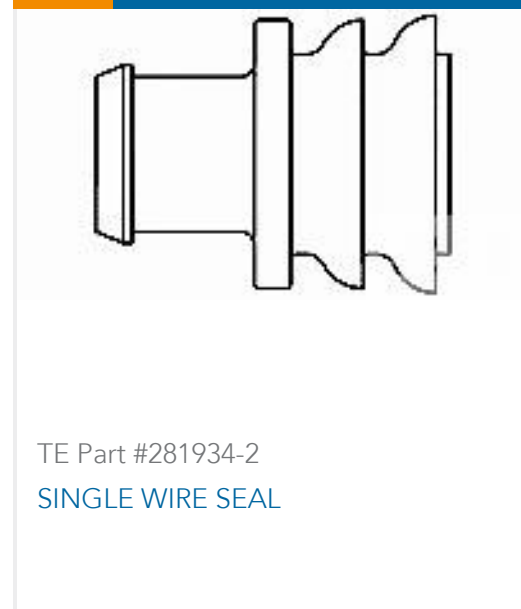

Documents

Product Drawings

DTM06-08SC-E003, PLG, 8P, GRY, N, CAP, C

English

Product Specifications

Application Specification

English

Agency Approvals

UL Report

English