

2232111-1 ✓ ACTIVE

FASTON | FASTON 250

TE Internal #: 2232111-1

Quick Disconnects, Receptacle, 20 – 12 AWG Wire Size, .5 – 4 mm²

Wire Size, Mating Tab Width 6.35 mm [.25 in], Flag, Brass, Tin

Plating, FASTON 250

[View on TE.com >](#)



Terminals & Splices > Quick Disconnects

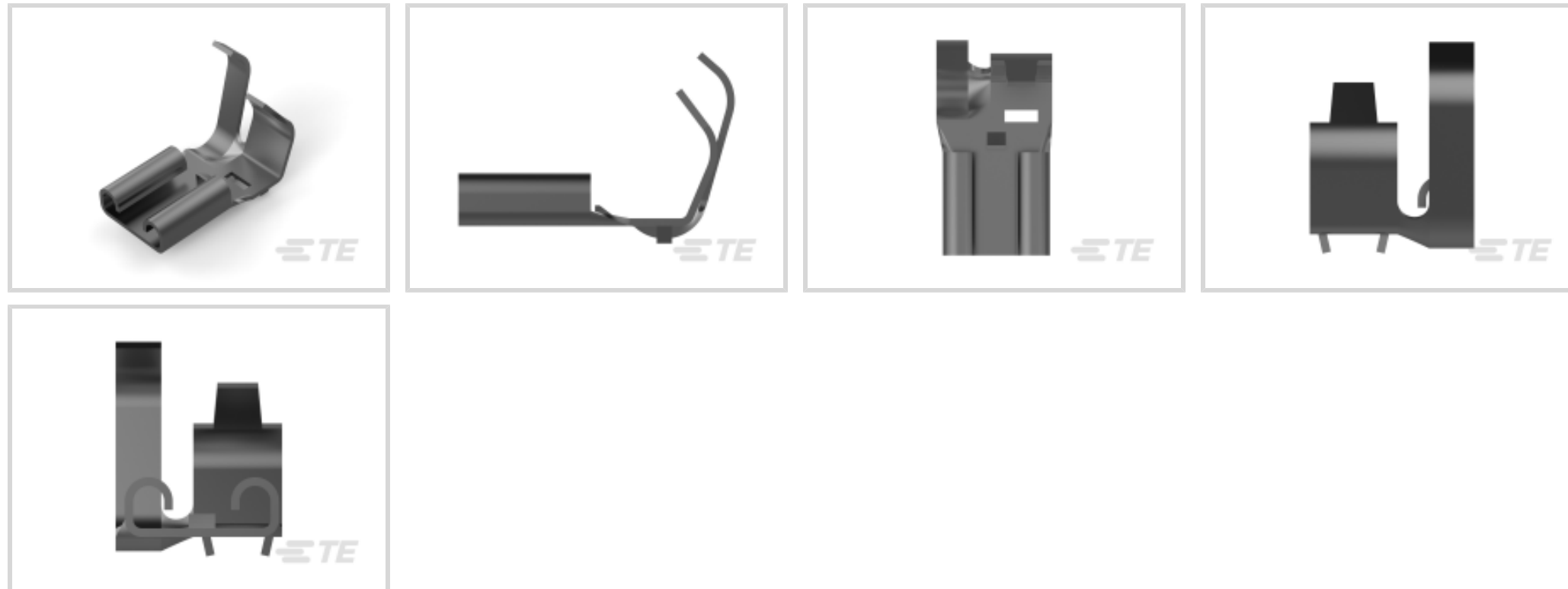

Quick Disconnect Terminal Type: **Receptacle**

Wire Size: .5 – 4 mm²

Mating Tab Width: 6.35 mm [.25 in]

Mating Tab Thickness: .81 mm [.032 in]

Features

Product Type Features

Insertion Force	Normal
-----------------	--------

Configuration Features

Connection Capacity	Single
---------------------	--------

Compatible With Wire & Cable Type	Discrete Wire
-----------------------------------	---------------

Contact Features

Quick Disconnect Terminal Type	Receptacle
--------------------------------	------------

Mating Tab Width	6.35 mm [.25 in]
------------------	------------------

Mating Tab Thickness	.81 mm [.032 in]
----------------------	------------------

Terminal Orientation	Flag
----------------------	------

Contact Base Material	Brass
-----------------------	-------

Terminal Plating Material	Tin
---------------------------	-----

Crimp Type	Tab-Lok
------------	---------

Barrel Type	Open
-------------	------

Termination Features



Product Terminates To	Wire & Cable
-----------------------	--------------

Mechanical Attachment

Locking Lance Height	1.02 mm
----------------------	---------

Wire Insulation Support	With
-------------------------	------

Mating Retention Type	Dimple
-----------------------	--------

Dimensions

Terminal Material Thickness	.46 mm[.018 in]
-----------------------------	-----------------

Product Length	17.02 mm[.67 in]
----------------	------------------

Compatible Insulation Diameter Range	2.79 – 5.33 mm[.11 – .21 in]
--------------------------------------	------------------------------

Wire Size	.5 – 4 mm ²
-----------	------------------------

Usage Conditions

Insulation Option	Uninsulated
-------------------	-------------

Operating Temperature Range	-40 – 110 °C[-40 – 230 °F]
-----------------------------	----------------------------

Industry Standards

Agency/Standard	CSA, UL
-----------------	---------

Packaging Features

Packaging Quantity	4000
--------------------	------

Packaging Method	Strip/Reel
------------------	------------

Other

Line	Premier
------	---------

Product Compliance

[For compliance documentation, visit the product page on TE.com>](#)

EU RoHS Directive 2011/65/EU	Compliant
------------------------------	-----------

EU ELV Directive 2000/53/EC	Compliant
-----------------------------	-----------

China RoHS 2 Directive MIIT Order No 32, 2016	No Restricted Materials Above Threshold
---	---

EU REACH Regulation (EC) No. 1907/2006	Current ECHA Candidate List: JUNE 2023 (235) Candidate List Declared Against: JUNE 2023 (235) Does not contain REACH SVHC
--	---

Halogen Content	Low Halogen - Br, Cl, F, I < 900 ppm per homogenous material. Also BFR/CFR/PVC Free
-----------------	---













Solder Process Capability

Not applicable for solder process capability

Product Compliance Disclaimer

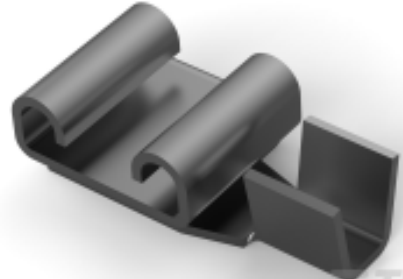
This information is provided based on reasonable inquiry of our suppliers and represents our current actual knowledge based on the information they provided. This information is subject to change. The part numbers that TE has identified as EU RoHS compliant have a maximum concentration of 0.1% by weight in homogenous materials for lead, hexavalent chromium, mercury, PBB, PBDE, DBP, BBP, DEHP, DIBP, and 0.01% for cadmium, or qualify for an exemption to these limits as defined in the Annexes of Directive 2011/65/EU (RoHS2). Finished electrical and electronic equipment products will be CE marked as required by Directive 2011/65/EU. Components may not be CE marked. Additionally, the part numbers that TE has identified as EU ELV compliant have a maximum concentration of 0.1% by weight in homogenous materials for lead, hexavalent chromium, and mercury, and 0.01% for cadmium, or qualify for an exemption to these limits as defined in the Annexes of Directive 2000/53/EC (ELV). Regarding the REACH Regulation, the information TE provides on SVHC in articles for this part number is based on the latest European Chemicals Agency (ECHA) 'Guidance on requirements for substances in articles' posted at this URL: <https://echa.europa.eu/guidance-documents/guidance-on-reach>

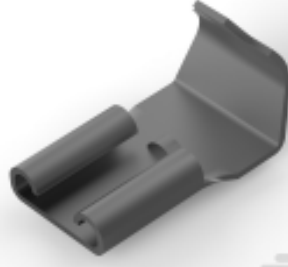
Compatible Parts

 <p>TE Part # 63555-2 250 FASTON FLAG REC 18-12 AWG TPBR</p>	 <p>TE Part # 63137-1 250 FASOTN FLAG REC 20-16 AWG TPBZ</p>	 <p>TE Part # 60851-1 250 FASTON REC 12-10 AWG TPBR</p>	 <p>TE Part # 41532 250 FASTON FLAG REC 18-12 AWG TPBR</p>
 <p>TE Part # 41800 250 FASTON FLAG REC 18-12 AWG TPBZ</p>	 <p>TE Part # 41802 250 FASTON FLAG REC 18-12 AWG TPBR</p>	 <p>TE Part # 63651-1 250 FASTON FLAG REC 18-12 AWG TPBZ</p>	 <p>TE Part # 63647-3 250 FASTON FLAG REC 18-14 AWG TPBR</p>
 <p>TE Part # 60274-2 250 FASTON FLAG REC 18-12 AWG TPBZ</p>	 <p>TE Part # 1217027-1 187 FASTON,FLAG,REC.,18-14 AWG, TPBR</p>	 <p>TE Part # 62021-3 250 FASTON FLAG REC 12-10 AWB TPBR</p>	 <p>TE Part # 63517-1 250 FASTON FLAG REC 18-12 AWG TPBR</p>



TE Part # 2232111-2
250 FASTON, FLAG, REC., 12-20 AWG,
BR



TE Part # 2232111-3
250 FASTON, FLAG, REC., 12-20 AWG,
TPBR



TE Part # 63555-1
250 FASTON FLAG REC 18-12 AWG
BR



TE Part # 687395-5
M HBEAPR160T K



TE Part # 687395-8
HINGE BAR 9EAPR160T180O G



TE Part # 7-1855041-7
SPARE PART KIT

Also in the Series | **FASTON 250**

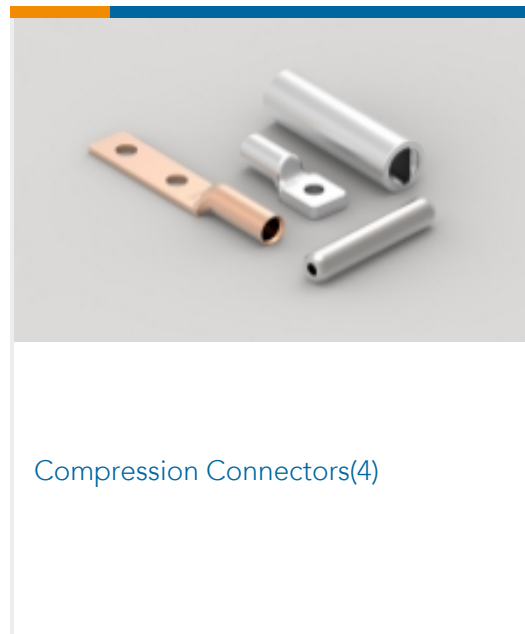

Compression Connectors(4)

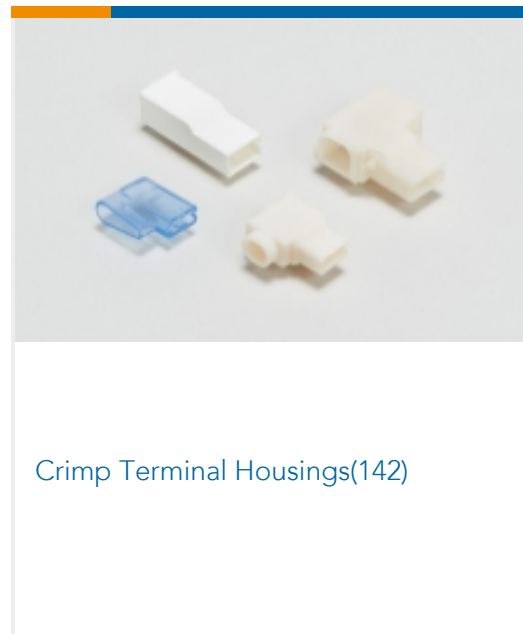

Crimp Terminal Housings(142)

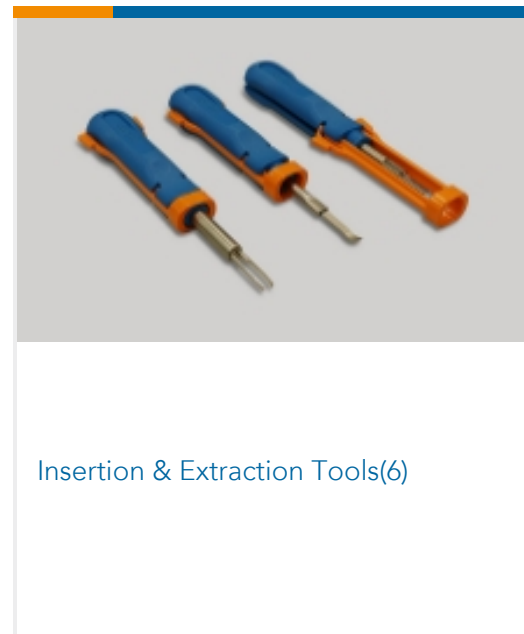

Insertion & Extraction Tools(6)



Magnet Wire Terminals(1)

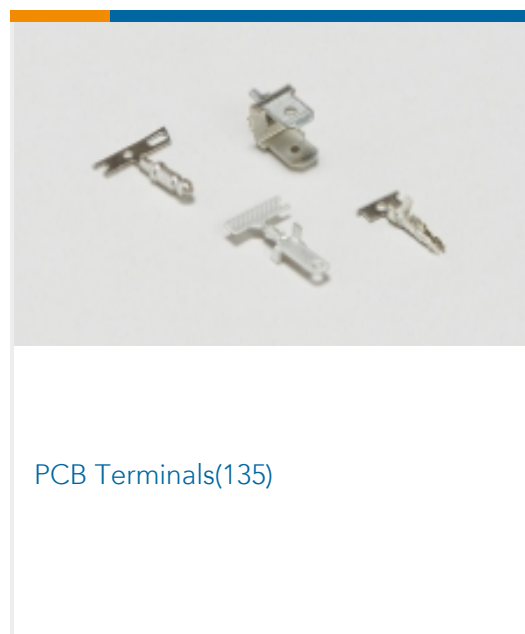

PCB Terminals(135)

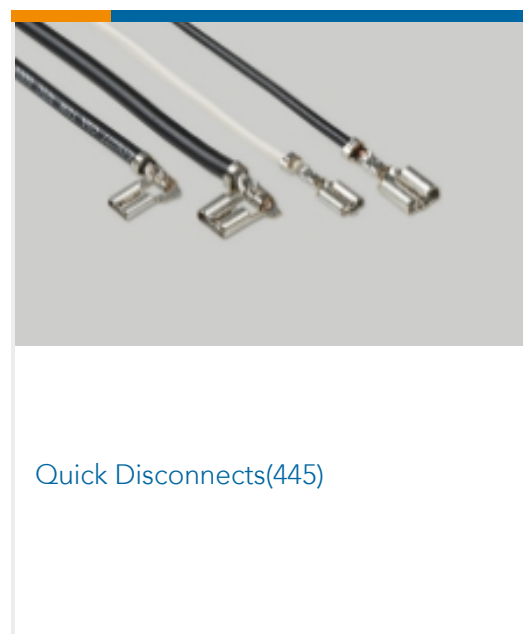

Quick Disconnects(445)

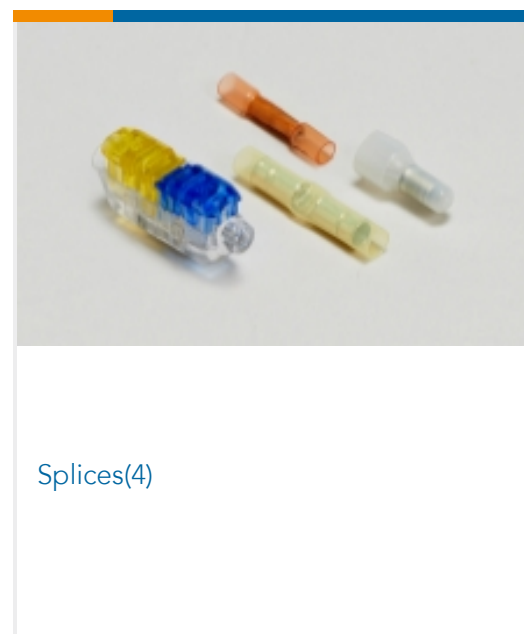

Splices(4)

Customers Also Bought

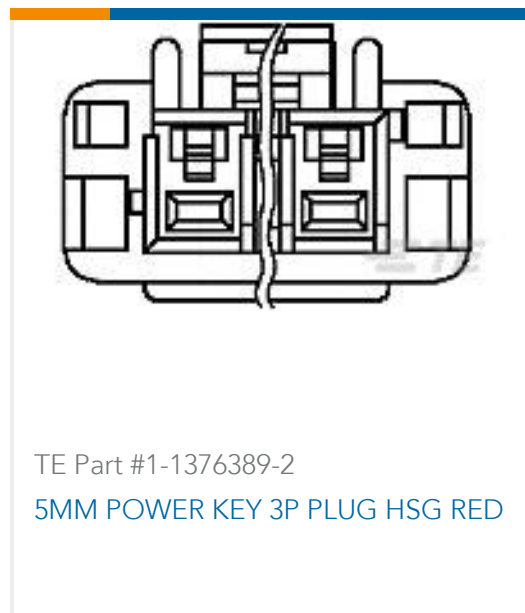

TE Part #1-1376389-2
5MM POWER KEY 3P PLUG HSG RED



TE Part #175020-1
250 PL EX REC. 22-18AWG PTBR



TE Part #964201-1
STD TIMER CONTACT



TE Part #175024-1
250 PL EX REC. 15-10AWG PTBR



TE Part #2232343-1
250 PL EX FLAG REC. 18-12AWG TPBR



TE Part #5-177912-1
POWER D/LOCK CAP HSG 10P NAT
(GWT)



TE Part #927831-2
SPT REC 6.3 Contact SRC Sn



TE Part #2299282-2
POD-LOK 250 STR. AWG 18-14 PTPBR
GF



TE Part #917722-1
2.5 SIGNAL D/LOCK HDR ASSY 2P



TE Part #521085-1
DRYER .250 HOUSING NYLON 6/6

Documents

Product Drawings

250 FASTON, FLAG, REC., 12-20 AWG, TPBR

English

CAD Files

3D PDF

3D

Customer View Model

[ENG_CVM_CVM_2232111-1_B.2d_dxf.zip](#)

English

Customer View Model

[ENG_CVM_CVM_2232111-1_B.3d_igs.zip](#)

English

Customer View Model

[ENG_CVM_CVM_2232111-1_B.3d_stp.zip](#)

English

By downloading the CAD file I accept and agree to the [Terms and Conditions](#) of use.

Product Specifications

Application Specification

English

Product Environmental Compliance

Product Compliance

English

Product Compliance

English



[Agency Approvals](#)

[Agency Approval Document](#)

English