

2205067-1 ✓ ACTIVE

Micro-MaTch | Micro-MaTch Industrial

TE Internal #: 2205067-1

MICRO-MATCH MOW Cable Assembly, 18 Positions, .246 ft [.075 m], Gray Cable, Equalized, 28 AWG, 159.8 – 159.88 mm², Ribbon Cable, MICRO-MATCH MOW Plug

[View on TE.com >](#)



Cable Assemblies > Copper Cable Assemblies > Pluggable I/O Cable Assemblies > MICRO-MATCH STD MOW TO MOW CABLE ASSY

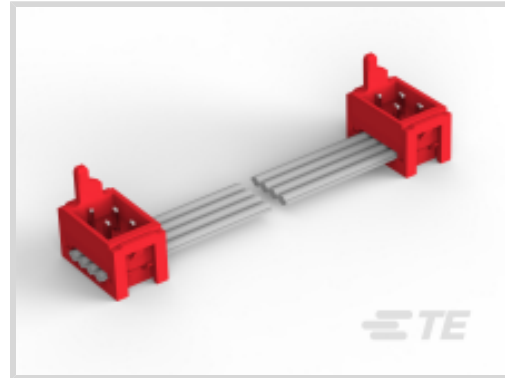

Cable Assembly Type: MICRO-MATCH MOW

Keyed Position: 1

Equalized: Yes

Wire Size: 159.8 – 159.88 mm²

[All MICRO-MATCH STD MOW TO MOW CABLE ASSY \(27\)](#)

Features

Product Type Features

Cable Assembly Category	Industry Standard
Cable Assembly Type	MICRO-MATCH MOW
Connector Type (End A)	MICRO-MATCH MOW Plug
Connector Type (End B)	MICRO-MATCH MOW Plug
Cable Style	Ribbon Cable

Configuration Features

Keyed Position	1
Number of Positions	18
Number of Signal Positions	18

Body Features

Equalized	Yes
Cable Color	Gray
Cable Flammability Rating	UL 2651

Mechanical Attachment

Mating Alignment	With
------------------	------

Dimensions

--	--



Wire Size	159.8 – 159.88 mm ²
-----------	--------------------------------

Operation/Application

Shielded	No
----------	----

Halogen Free	No
--------------	----

Other

Cable Assembly Configuration	Double Ended
------------------------------	--------------

Cable Assembly Length	.075 m [.246 ft]
-----------------------	------------------

Product Compliance

[For compliance documentation, visit the product page on TE.com>](#)

EU RoHS Directive 2011/65/EU	Compliant
------------------------------	-----------

EU ELV Directive 2000/53/EC	Compliant
-----------------------------	-----------

China RoHS 2 Directive MIIT Order No 32, 2016	No Restricted Materials Above Threshold
---	---

EU REACH Regulation (EC) No. 1907/2006	Current ECHA Candidate List: JUNE 2023 (235) Candidate List Declared Against: JAN 2022 (223) Does not contain REACH SVHC
--	--

Halogen Content	Not Low Halogen - contains Br or Cl > 900 ppm.
-----------------	--

Solder Process Capability	Not reviewed for solder process capability
---------------------------	--

Product Compliance Disclaimer

This information is provided based on reasonable inquiry of our suppliers and represents our current actual knowledge based on the information they provided. This information is subject to change. The part numbers that TE has identified as EU RoHS compliant have a maximum concentration of 0.1% by weight in homogenous materials for lead, hexavalent chromium, mercury, PBB, PBDE, DBP, BBP, DEHP, DIBP, and 0.01% for cadmium, or qualify for an exemption to these limits as defined in the Annexes of Directive 2011/65/EU (RoHS2). Finished electrical and electronic equipment products will be CE marked as required by Directive 2011/65/EU. Components may not be CE marked. Additionally, the part numbers that TE has identified as EU ELV compliant have a maximum concentration of 0.1% by weight in homogenous materials for lead, hexavalent chromium, and mercury, and 0.01% for cadmium, or qualify for an exemption to these limits as defined in the Annexes of Directive 2000/53/EC (ELV). Regarding the REACH Regulation, the information TE provides on SVHC in articles for this part number is based on the latest European Chemicals Agency (ECHA) 'Guidance on requirements for substances in articles' posted at this URL: <https://echa.europa.eu/guidance-documents/guidance-on-reach>

Compatible Parts



Also in the Series | Micro-MaTch Industrial

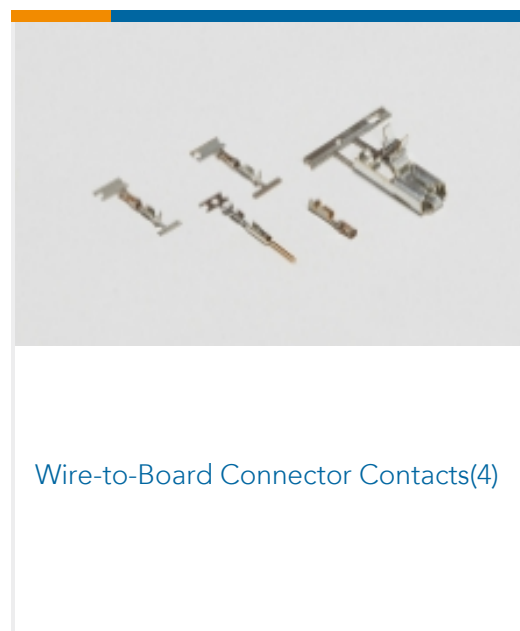
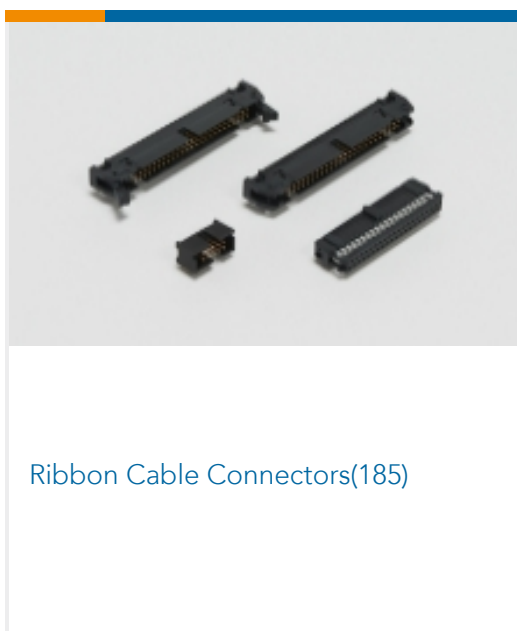
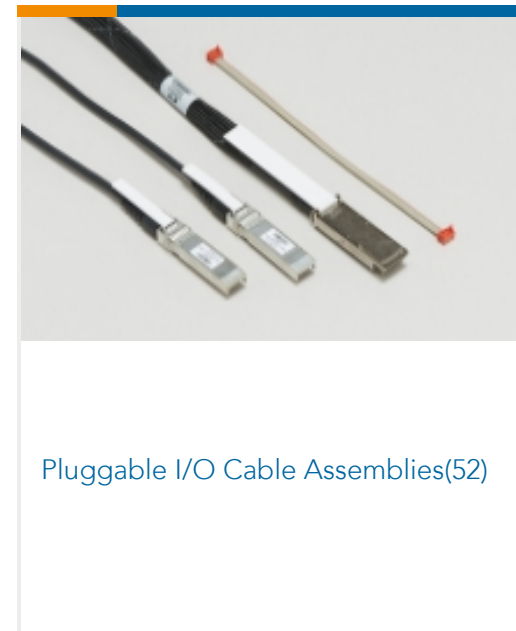
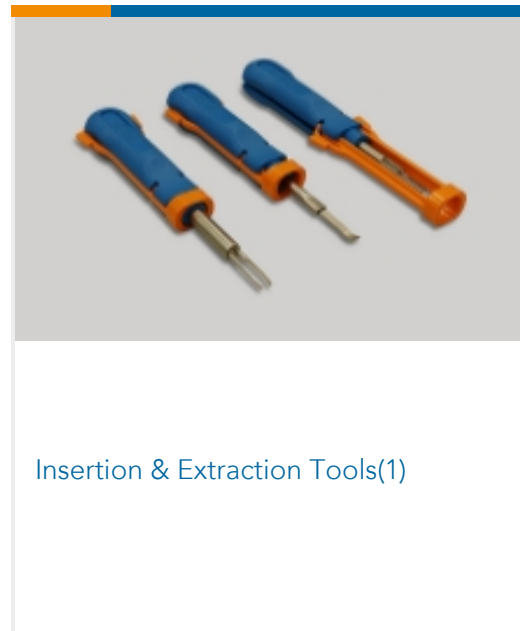
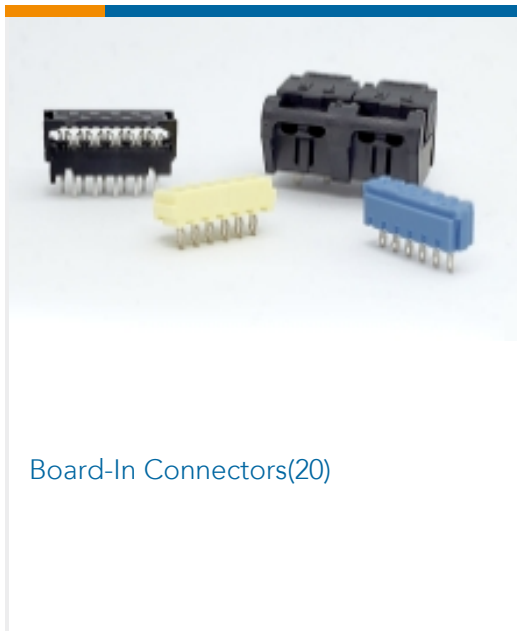

Customers Also Bought

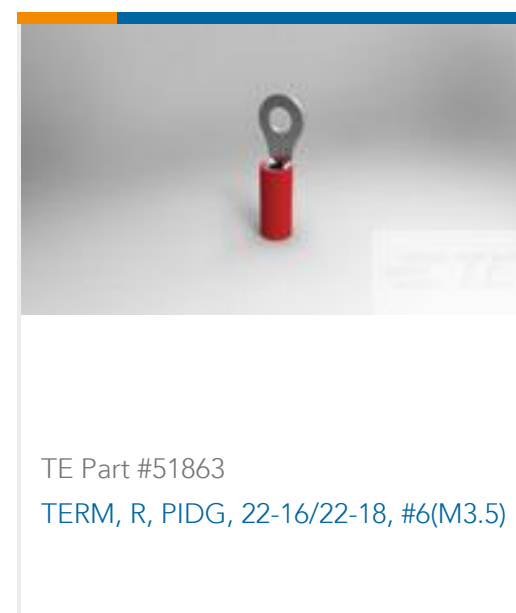
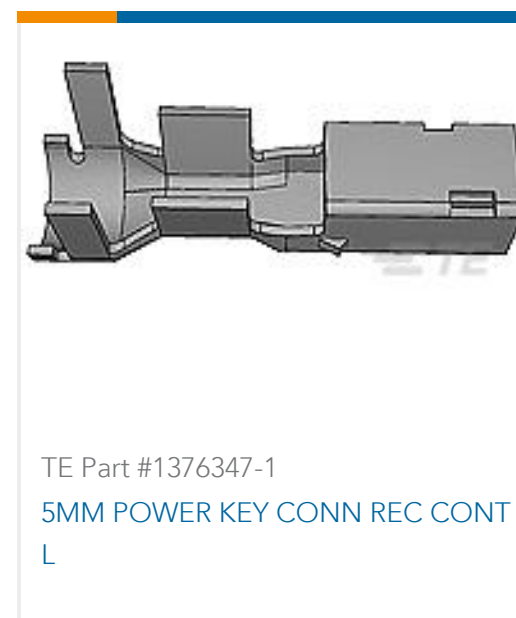



Documents

Product Drawings

[CA MICRO-MATCH MOW-MOW 18POS](#)

English

Product Specifications

[Application Specification](#)

English

[micro match miniature connector system](#)

English