



AMP

TE Internal #: 220066-1

Hand Crimping Tools, Premium Crimp Tooling, Not Releasable, Not Adjustable, Fixed In Tool, TE Product Specification (114-), Battery / Manual

[View on TE.com >](#)

Application Tooling > Hand Crimping Tools



Tool Grade: **Premium Crimp Tooling**

Ratchet Configuration: **Not Releasable, Not Adjustable**

Die Sets Type: **Fixed In Tool**

Specification Type: **TE Product Specification (114-)**

TE Certification: **Yes – Certificate Included**

Features

Other

Crimp Form-Wire Barrel Type	Closed Barrel - COAX
Tool Grade	Premium Crimp Tooling
Ratchet Configuration	Not Releasable, Not Adjustable
Die Sets Type	Fixed In Tool
Specification Type	TE Product Specification (114-)
TE Certification	Yes – Certificate Included
Power Technology Type	Battery, Manual
Tooling Type	Double Action Hand Tool

Product Compliance

[For compliance documentation, visit the product page on TE.com>](#)





EU RoHS Directive 2011/65/EU	Out of Scope
EU ELV Directive 2000/53/EC	Out of Scope
China RoHS 2 Directive MIIT Order No 32, 2016	Not reviewed for China RoHS compliance
EU REACH Regulation (EC) No. 1907/2006	Current ECHA Candidate List: JUNE 2023 (235) Candidate List Declared Against: JUL 2021 (219) Does not contain REACH SVHC

Halogen Content	Low Halogen - Br, Cl, F, I < 900 ppm per homogenous material. Also BFR/CFR/PVC Free
Solder Process Capability	Not applicable for solder process capability

Product Compliance Disclaimer

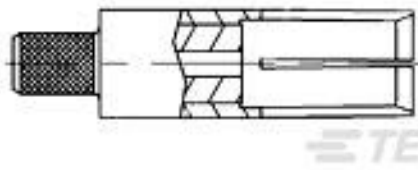
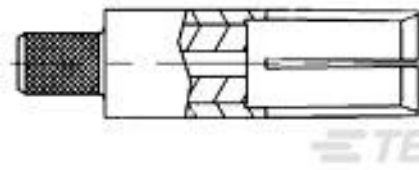
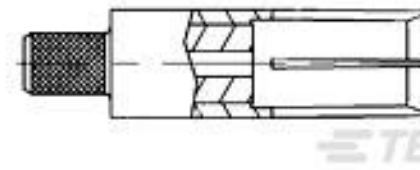
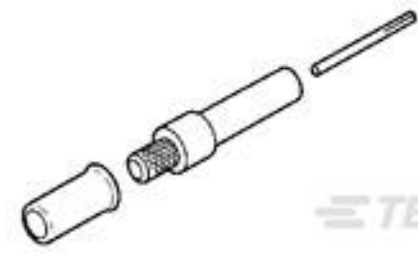
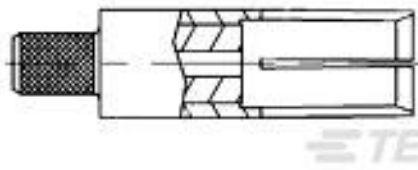
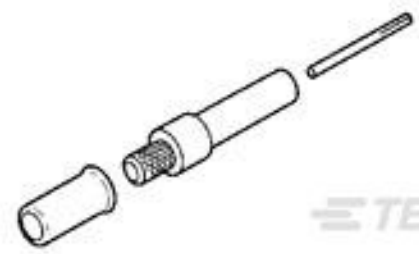
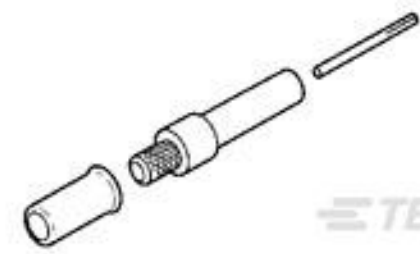
This information is provided based on reasonable inquiry of our suppliers and represents our current actual knowledge based on the information they provided. This information is subject to change. The part numbers that TE has identified as EU RoHS compliant have a maximum concentration of 0.1% by weight in homogenous materials for lead, hexavalent chromium, mercury, PBB, PBDE, DBP, BBP, DEHP, DIBP, and 0.01% for cadmium, or qualify for an exemption to these limits as defined in the Annexes of Directive 2011/65/EU (RoHS2). Finished electrical and electronic equipment products will be CE marked as required by Directive 2011/65/EU. Components may not be CE marked. Additionally, the part numbers that TE has identified as EU ELV compliant have a maximum concentration of 0.1% by weight in homogenous materials for lead, hexavalent chromium, and mercury, and 0.01% for cadmium, or qualify for an exemption to these limits as defined in the Annexes of Directive 2000/53/EC (ELV). Regarding the REACH Regulation, the information TE provides on SVHC in articles for this part number is based on the latest European Chemicals Agency (ECHA) 'Guidance on requirements for substances in articles' posted at this URL: <https://echa.europa.eu/guidance-documents/guidance-on-reach>

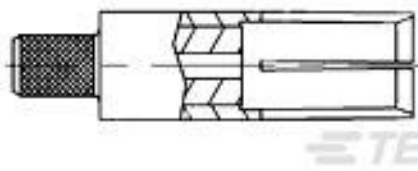
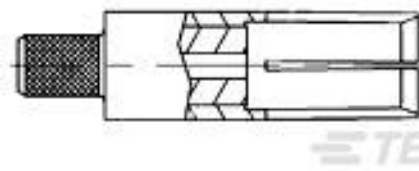
Compatible Parts

 <p>TE Part # 225791-2 COAXIAL RF SOCKET, SZ 5</p>	 <p>TE Part # 225791-3 ARINC COAXICON SOCKET SIZE 5</p>	 <p>TE Part # 225791-4 ARINC SIZE 5 SOCKET</p>	 <p>TE Part # 225790-5 ARINC COAXICON PIN SIZE 5</p>
 <p>TE Part # 225791-1 KIT, ARINC SOCKET, SIZE 5</p>	 <p>TE Part # 225790-1 ARINC PIN SIZE 5</p>	 <p>TE Part # 225790-4 ARINC COAXICON PIN SIZE 5</p>	 <p>TE Part # 225790-7 ARINC PIN SIZE 5</p>
 <p>TE Part # 225791-8 ARINC - SKT SIZE 5</p>	 <p>TE Part # 225791-9 ARINC - SKT SIZE 5</p>	 <p>TE Part # 225796-2 ARINC SOC SIZE 7</p>	 <p>TE Part # 225837-1 ARINC COAXICON PIN SIZE 1</p>

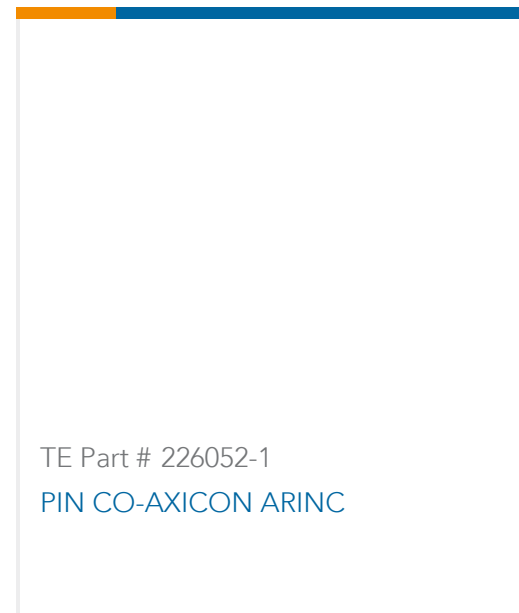
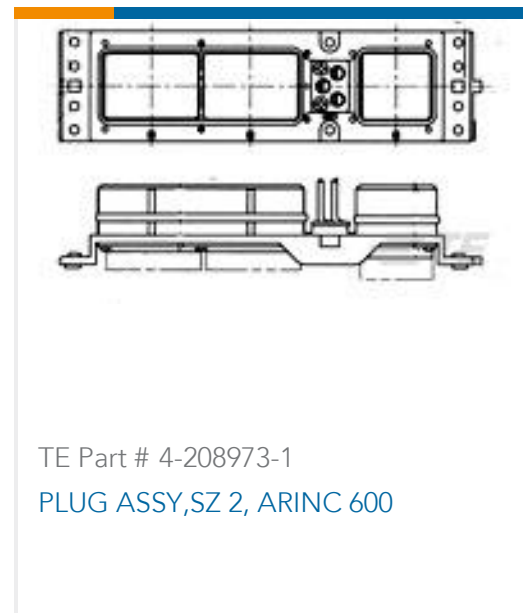

Customers Also Bought

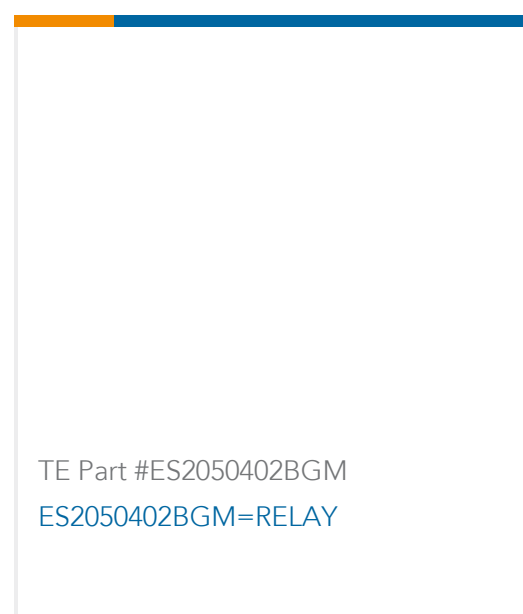
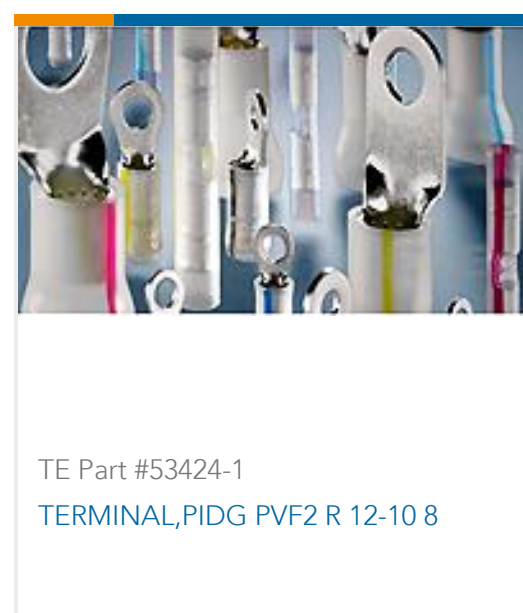
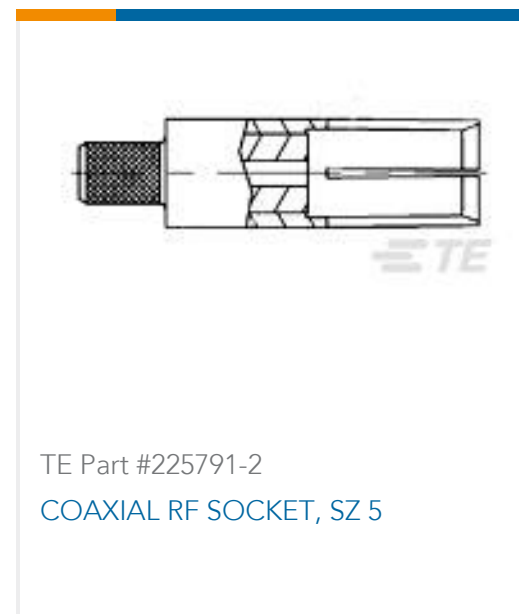

Documents

Datasheets & Catalog Pages

Bottoming Dies

English

Instruction Sheets

Instruction Sheet (U.S.)

English

Hand Crimping Tool 220066-1

English

