



zQSFP+/QSFP28

TE Internal #: 2170738-1

QSFP, QSFP+ & zQSFP+, Cage Assembly, 1 x 3, Internal/External

EMI Springs, Standard, Data Rate (Max) 28 Gb/s, 3 Port, Pin,

zQSFP+/QSFP28

[View on TE.com >](#)

Connectors > Pluggable IO Connectors & Cages > QSFP, QSFP+ & zQSFP+

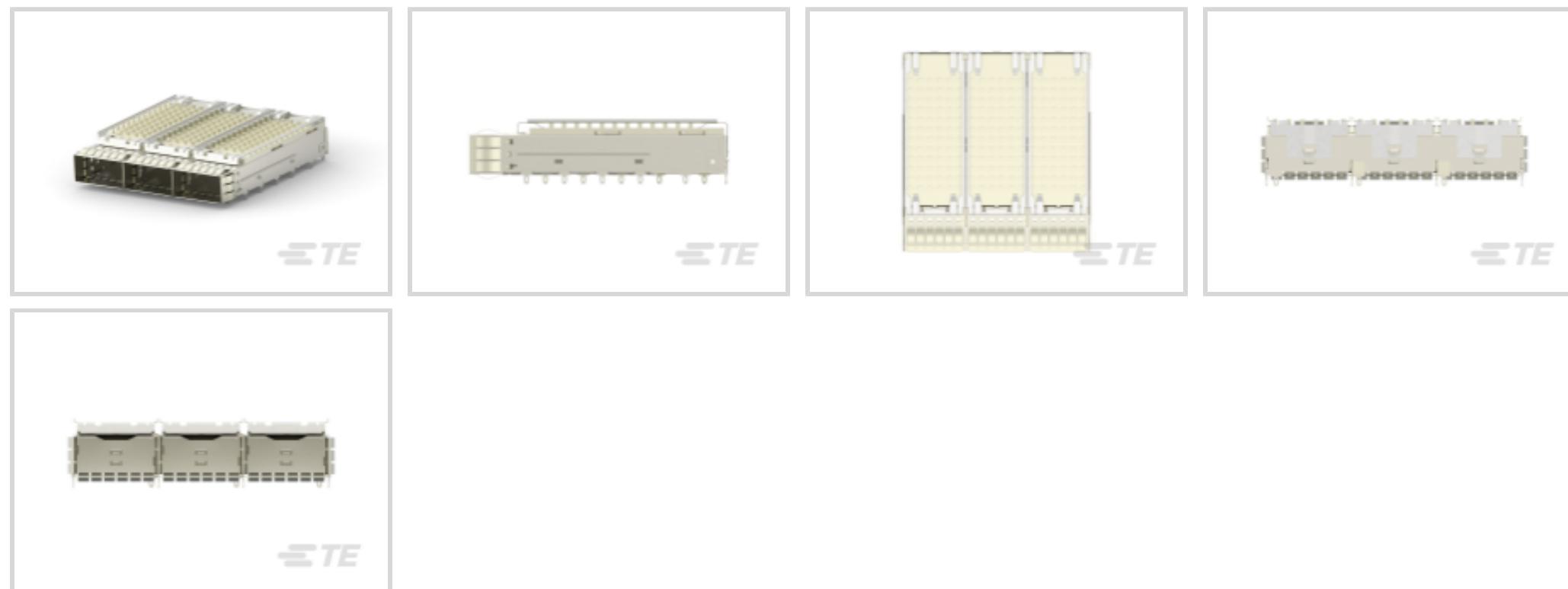

Pluggable I/O Product Type: **Cage Assembly**

Port Matrix Configuration: **1 x 3**

EMI Containment Feature Type: **Internal/External EMI Springs**

Thermal Accessory Type Included: **Heat Sink**

Included Lightpipe: **No**

Features

Product Type Features

Form Factor	QSFP28/56
Cage Type	Ganged
Pluggable I/O Product Type	Cage Assembly
Thermal Accessory Type Included	Heat Sink
Connector System	Cable-to-Board
Sealable	No
Connector & Contact Terminates To	Printed Circuit Board

Configuration Features

Port Matrix Configuration	1 x 3
Number of Ports	3
Number of Rear EONs per Port Column	1

Electrical Characteristics

Data Rate (Max)	28 Gb/s
-----------------	---------

Body Features



Heat Sink Finish	Anodized Black
Heat Sink Style	Pin
Heat Sink Height Class	PCI
Heat Sink Height	4.2 mm[.165 in]

Contact Features

PCB Contact Termination Area Plating Material	Tin
---	-----

Termination Features

Termination Post & Tail Length	2.05 mm[.081 in]
Termination Method to Printed Circuit Board	Through Hole - Press-Fit

Mechanical Attachment

Connector Mounting Type	Board Mount
-------------------------	-------------

Housing Features

Cage Material	Nickel Silver
---------------	---------------

Dimensions

PCB Thickness (Recommended)	1.57 mm[.062 in]
-----------------------------	------------------

Usage Conditions

Operating Temperature Range	-55 – 105 °C[-67 – 221 °F]
-----------------------------	----------------------------

Operation/Application

For Use With Pluggable I/O Products	QSFP28 Cable Assembly, QSFP28 MSA Compatible Transceiver
Pluggable I/O Applications	SFP+ Stacked Belly-to-Belly
Circuit Application	Signal

Industry Standards

UL Flammability Rating	UL 94V-0
------------------------	----------

Packaging Features

Packaging Method	Box & Tray
------------------	------------

Other

EMI Containment Feature Type	Internal/External EMI Springs
Included Lightpipe	No
Enhancements	Standard



Product Compliance





[For compliance documentation, visit the product page on TE.com>](#)

EU RoHS Directive 2011/65/EU	Compliant
EU ELV Directive 2000/53/EC	Compliant
China RoHS 2 Directive MIIT Order No 32, 2016	No Restricted Materials Above Threshold
EU REACH Regulation (EC) No. 1907/2006	Current ECHA Candidate List: JUNE 2023 (235) Candidate List Declared Against: JUNE 2023 (235) Does not contain REACH SVHC
Halogen Content	Low Halogen - Br, Cl, F, I < 900 ppm per homogenous material. Also BFR/CFR/PVC Free
Solder Process Capability	Not reviewed for solder process capability

Product Compliance Disclaimer

This information is provided based on reasonable inquiry of our suppliers and represents our current actual knowledge based on the information they provided. This information is subject to change. The part numbers that TE has identified as EU RoHS compliant have a maximum concentration of 0.1% by weight in homogenous materials for lead, hexavalent chromium, mercury, PBB, PBDE, DBP, BBP, DEHP, DIBP, and 0.01% for cadmium, or qualify for an exemption to these limits as defined in the Annexes of Directive 2011/65/EU (RoHS2). Finished electrical and electronic equipment products will be CE marked as required by Directive 2011/65/EU. Components may not be CE marked. Additionally, the part numbers that TE has identified as EU ELV compliant have a maximum concentration of 0.1% by weight in homogenous materials for lead, hexavalent chromium, and mercury, and 0.01% for cadmium, or qualify for an exemption to these limits as defined in the Annexes of Directive 2000/53/EC (ELV). Regarding the REACH Regulation, the information TE provides on SVHC in articles for this part number is based on the latest European Chemicals Agency (ECHA) 'Guidance on requirements for substances in articles' posted at this URL: <https://echa.europa.eu/guidance-documents/guidance-on-reach>

Compatible Parts

 <p>TE Part # CAT-C11-Z806726 QSFP28 to QSFP28 Cable Assembly: 30 AWG</p>	 <p>TE Part # CAT-C11-N49 QSFP28-Two QSFP28 Cable Assembly: 30 AWG</p>	 <p>TE Part # CAT-C11-Z8 QSFP28 to QSFP28 Cable Assembly: 26 AWG</p>	 <p>TE Part # CAT-C11-N490333 QSFP28-Four SFP+ Cable Assembly: 30 AWG</p>
--	--	---	--



TE Part # CAT-C11-N490325
QSFP28-Four SFP+ Cable Assembly:
26 AWG



TE Part # CAT-Q17-N490325
QSFP56 to QSFP56 Cable Assembly:
30 AWG



TE Part # CAT-Q17-N49033
QSFP56-Two QSFP56 Cable
Assembly: 30 AWG



TE Part # CAT-C11-Q17
QSFP56 to QSFP56 Cable Assembly:
26 AWG



TE Part # CAT-Q17-N49011
QSFP56-Four SFP56 Cable Assembly:
30 AWG



TE Part # CAT-Q17-N490333
QSFP56-Four SFP56 Cable Assembly:
26 AWG



TE Part # 1888810-2
EMI/Dust Cover, XFP And QSFP



TE Part # 1551920-2
zQSFP+ connector assembly

TE Part # 6-2215048-3
ASSY, SEATING TL, QSFP28, 1X3

Also in the Series | **zQSFP+/QSFP28**

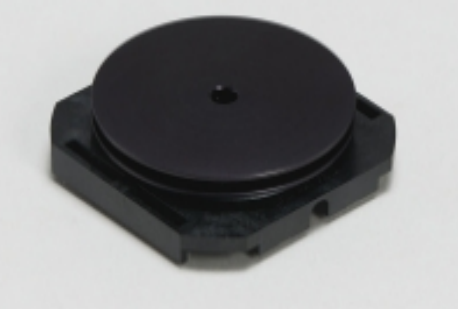

Heat Sinks(1)



Pluggable I/O Cable Assemblies(81)



QSFP, QSFP+ & zQSFP+(425)

Customers Also Bought



TE Part #1-1462038-7
IM07NS=IM RELAY 200mW 24V



TE Part #2291579-1
ZSFP+ 1X1 CAGE ASSEMBLY, PCI,
PRESS-FIT,

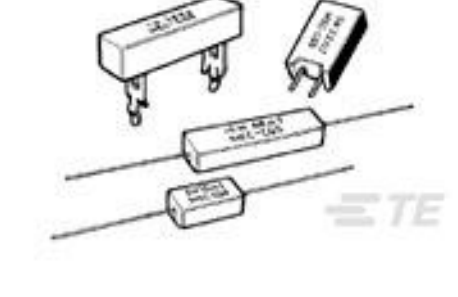

TE Part #1-1623783-4
SQM7 47K 5% (METAL FILM)



TE Part #9-215083-4
MICRO-MATCH MOW.24P



Documents

Product Drawings

QSFP28, 1X3, CAGE ASSEMBLY, SPRING, HS

English

CAD Files

3D PDF

3D

Customer View Model

[ENG_CVM_CVM_2170738-1_1.2d_dxf.zip](#)

English

Customer View Model

[ENG_CVM_CVM_2170738-1_1.3d_igs.zip](#)

English

Customer View Model

[ENG_CVM_CVM_2170738-1_1.3d_stp.zip](#)

English

By downloading the CAD file I accept and agree to the [Terms and Conditions](#) of use.

Datasheets & Catalog Pages

QSFP28/56 and zQSFP+ Interconnects

English

Product Specifications

Application Specification

English

Product Environmental Compliance

MD_2170738-1_02102015857_dmtec



English

[MD_2170738-1_02102015857_dmtec](#)

English

TE Material Declaration

English