



AMP

TE Internal #: 2063438-2

Hand Crimping Tools, Commercial Crimp Tooling, TE Product Specification (114-), SDE Crimp Die Set

[View on TE.com >](#)

Application Tooling > Hand Crimping Tools



Tool Grade: **Commercial Crimp Tooling**

Specification Type: **TE Product Specification (114-)**

TE Certification: **No**

Tooling Type: **SDE Crimp Die Set**

Features

Other

Crimp Form-Wire Barrel Type	Open Barrel - F Crimp
Tool Grade	Commercial Crimp Tooling
Specification Type	TE Product Specification (114-)
TE Certification	No
Tooling Type	SDE Crimp Die Set

Product Compliance

[For compliance documentation, visit the product page on TE.com>](#)

EU RoHS Directive 2011/65/EU	Out of Scope
EU ELV Directive 2000/53/EC	Out of Scope
China RoHS 2 Directive MIIT Order No 32, 2016	Not reviewed for China RoHS compliance
EU REACH Regulation (EC) No. 1907/2006	Current ECHA Candidate List: JUNE 2023 (235) Candidate List Declared Against: JAN 2023 (233) Does not contain REACH SVHC
Halogen Content	Low Halogen - Br, Cl, F, I < 900 ppm per

homogenous material. Also BFR/CFR/PVC Free







Solder Process Capability

Not applicable for solder process capability

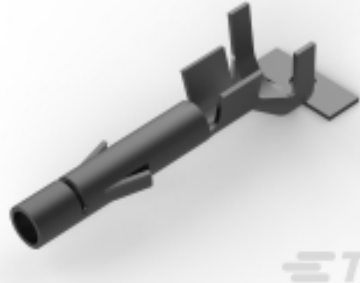
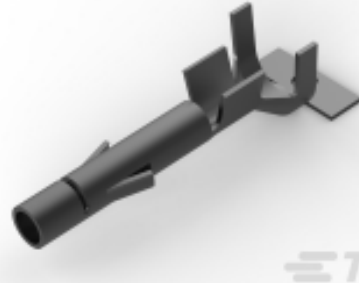
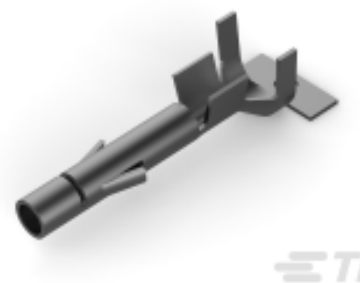
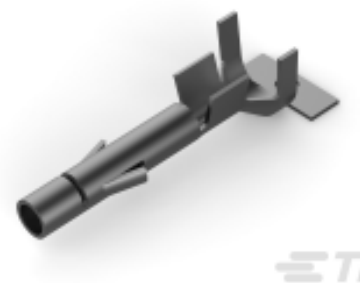
Product Compliance Disclaimer

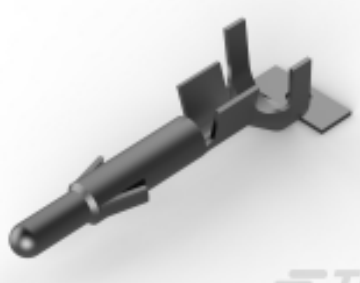
This information is provided based on reasonable inquiry of our suppliers and represents our current actual knowledge based on the information they provided. This information is subject to change. The part numbers that TE has identified as EU RoHS compliant have a maximum concentration of 0.1% by weight in homogenous materials for lead, hexavalent chromium, mercury, PBB, PBDE, DBP, BBP, DEHP, DIBP, and 0.01% for cadmium, or qualify for an exemption to these limits as defined in the Annexes of Directive 2011/65/EU (RoHS2). Finished electrical and electronic equipment products will be CE marked as required by Directive 2011/65/EU. Components may not be CE marked. Additionally, the part numbers that TE has identified as EU ELV compliant have a maximum concentration of 0.1% by weight in homogenous materials for lead, hexavalent chromium, and mercury, and 0.01% for cadmium, or qualify for an exemption to these limits as defined in the Annexes of Directive 2000/53/EC (ELV). Regarding the REACH Regulation, the information TE provides on SVHC in articles for this part number is based on the latest European Chemicals Agency (ECHA) 'Guidance on requirements for substances in articles' posted at this URL: <https://echa.europa.eu/guidance-documents/guidance-on-reach>

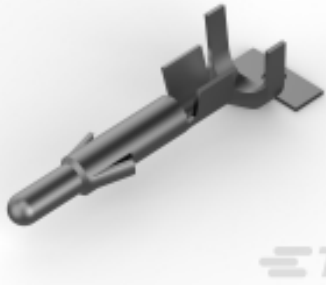
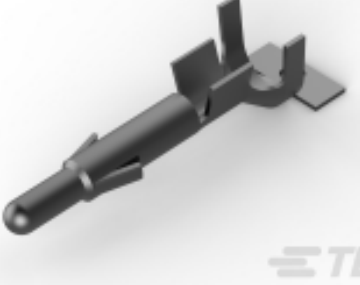
Compatible Parts

 <p>TE Part # 926901-3 UNIV-MNL BUCHSE</p>	 <p>TE Part # 926901-1 UMNL Socket 16-13 AWG</p>	 <p>TE Part # 926869-3 UNIV-MNL SOCKET 1</p>	 <p>TE Part # 926869-1 UNIV.M-N-L.SOCKET</p>
 <p>TE Part # 926899-1 TERM MACHO UNIVER.MATE-N-LOK</p>	 <p>TE Part # 926900-1 UNIV-MNL STIFT</p>	 <p>TE Part # 926899-3 UNIV-MNL SPLIT ST</p>	 <p>TE Part # 926868-3 UNIV-MNL PIN 1</p>
 <p>TE Part # 926868-1 UNIV.M-N-L.PIN</p>	 <p>TE Part # 926900-3 UNIV-MNL STIFT</p>	 <p>TE Part # 2063438-1 SDE UMNL 1.5-2.5mm2 ASSY</p>	 <p>TE Part # 2362810-1 SDE CRIMP HAND TOOL FRAME W /O DIES</p>



Customers Also Bought

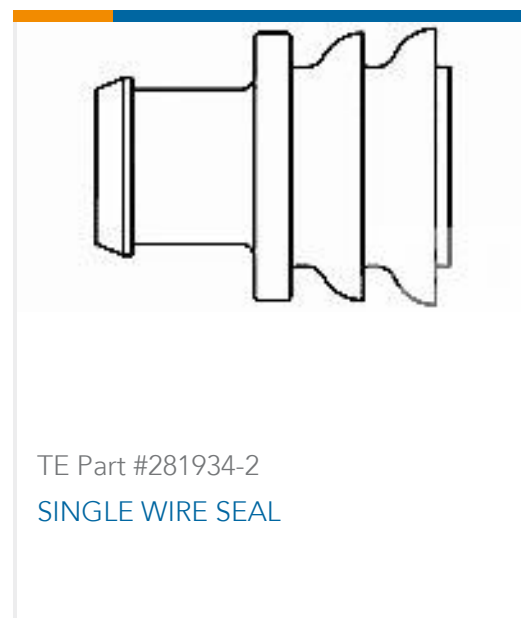
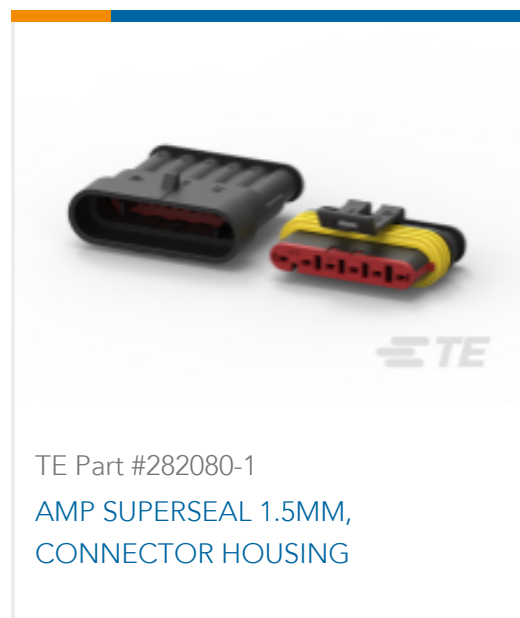

Documents

Datasheets & Catalog Pages

CRIMPING TERMINALS

English

CRIMPING WHERE FORM MEETS FUNCTION

English

Bottoming Dies

English

SDE Crimp Commercial Tool System

English

Instruction Sheets

Instruction Sheet (U.S.)

English