



Application Tooling > Insertion & Extraction Tools



Insertion & Extraction Tool Type: **Contact Extraction**

Insertion & Extraction Tool Application: **Contact-to-Housing**

Features

Product Type Features

Insertion & Extraction Tool Type	Contact Extraction
Insertion & Extraction Tool Application	Contact-to-Housing

Product Compliance

[For compliance documentation, visit the product page on TE.com>](#)

EU RoHS Directive 2011/65/EU	Compliant
EU ELV Directive 2000/53/EC	Compliant
China RoHS 2 Directive MIIT Order No 32, 2016	No Restricted Materials Above Threshold
EU REACH Regulation (EC) No. 1907/2006	Current ECHA Candidate List: JUNE 2023 (235) Candidate List Declared Against: JUNE 2023 (235) Does not contain REACH SVHC
Halogen Content	Low Halogen - Br, Cl, F, I < 900 ppm per homogenous material. Also BFR/CFR/PVC Free
Solder Process Capability	Not applicable for solder process capability

Product Compliance Disclaimer

This information is provided based on reasonable inquiry of our suppliers and represents our current actual knowledge based on the information they provided. This information is subject to change. The part numbers that TE has identified as EU RoHS compliant have a maximum concentration of 0.1% by weight in homogenous materials for lead, hexavalent chromium, mercury, PBB, PBDE, DBP, BBP, DEHP, DIBP, and 0.01% for cadmium, or qualify for an exemption to these limits as defined in the Annexes of Directive 2011/65/EU (RoHS2). Finished electrical and electronic equipment products will be CE marked as required by Directive 2011/65/EU. Components may not be CE marked. Additionally, the part numbers that TE has identified as EU ELV compliant have a maximum concentration of 0.1% by weight in homogenous materials for lead, hexavalent chromium, and mercury, and 0.01% for cadmium, or qualify for an exemption to these limits as defined in the Annexes of Directive 2000/53/EC (ELV). Regarding the REACH Regulation, the information TE provides

on SVHC in articles for this part number is based on the latest European Chemicals Agency (ECHA) 'Guidance on requirements for substances in articles' posted at this URL: <https://echa.europa.eu/guidance-documents/guidance-on-reach>

Compatible Parts



TE Part # 794017-1
.062 CP&S PIN PTPBR L/P 24-18



TE Part # 350968-2
MR PIN 26-24 AU/PHBZ



TE Part # 350629-5
.062 COMM P&S PIN AUNI/BR



TE Part # 350967-1
MR PIN PTPPHBZ



TE Part # 350967-2
MR PIN AU/PHBZ



TE Part # 640391-1
.062 COMM P&S PIN 24-30 PTPBR



TE Part # 641294-1
MR RECPT 26-18 PTPHBZ



TE Part # 350629-1
.062 COMM P&S PIN 18-24 PTPBR



TE Part # 350629-8
.062 COMM P&S PIN PRE TIN/PHBZ



TE Part # 640545-2
MR SPLIT PIN 26-18 AUPHBRZ LP



TE Part # 640579-2
MR SPLIT PIN AUPHBRZ LP 26-24



TE Part # 794000-1
MR RECEPTACLE PTPPHBZ



TE Part # 794001-1
MR RECPT PTPPHBZ LP 26-24

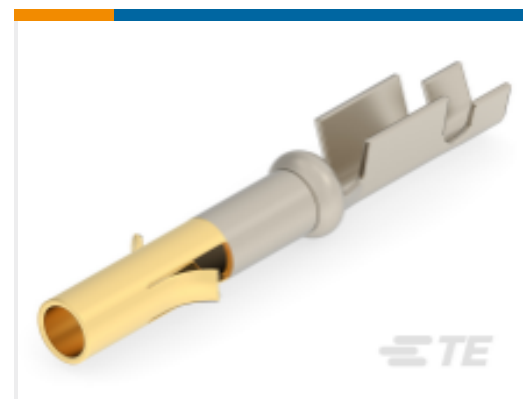

TE Part # 794001-2
MR RECPT AU PHBZ LP 26-24



TE Part # 640580-2
MR SPLIT PIN AUPHBRZ LP 26-18



TE Part # 350968-1
MR PIN 26-24 PTPPHBZ



TE Part # 350969-1
MR GRND PIN 26-18 PTPPHBZ



TE Part # 640579-1
MR SPLIT PIN PTPHBRZ LP 26-24



TE Part # 794000-2
MR RECEPTACLE AU PHBZ



TE Part # 640580-1
MR SPLIT PIN PTPHBRZ LP 26-18

Also in the Series | Commercial Pin and Socket Connectors



Connector Contacts(2)



Crimp Wire Pins, Tabs & Ferrules(1)



Insertion & Extraction Tools(2)



Power Contacts(39)



Rectangular Connector Housings(10)



Rectangular Power Connectors(84)



Standard Rectangular Connectors(1)

Customers Also Bought



TE Part #2204403-1
MULTI-BEAM HD R/A REC.2P

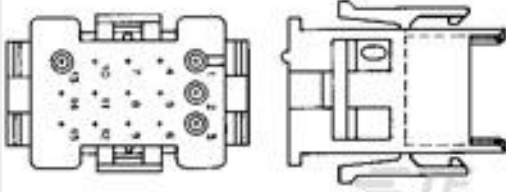

TE Part #1-640510-0
06P MR II CAP HSG V0



TE Part #2-747580-3
SHLDING FERRULE,PLTD TIN,BULK



TE Part #640545-2
MR SPLIT PIN 26-18 AUPHBRZ LP



TE Part #2-1393122-6
KHAU-17A11N-120=KH



TE Part #3-2176246-4
CRGS2512 5% 560R



TE Part #2-1618240-7
K43C334=RELAY, VACUUM, SPDT



TE Part #5-2176475-5
RA73F 1J 21K5 0.1% 1K RL

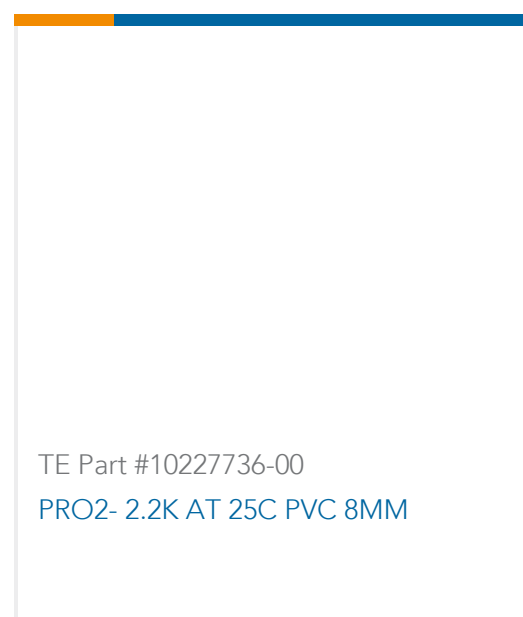

Documents

Instruction Sheets

[Instruction Sheet \(U.S.\)](#)

English