



Connectors > Connector Accessories > Connector Backshells > AMPSEAL 16 Connectors Backshell



Connector Backshell Product Type: **Backshell**

Primary Product Material: **Nylon**

Number of Positions: **4**

[All AMPSEAL 16 Connectors Backshell \(82\)](#)

Features

Product Type Features

Connector Backshell Product Type	Backshell
----------------------------------	-----------

Configuration Features

Number of Positions	4
---------------------	---

Body Features

Primary Product Color	Black
Primary Product Material	Nylon

Packaging Features

Packaging Quantity	1
Packaging Method	Package

Other

Serviceable	No
-------------	----

Product Compliance

[For compliance documentation, visit the product page on TE.com>](#)

EU RoHS Directive 2011/65/EU	Compliant
------------------------------	-----------

EU ELV Directive 2000/53/EC	Compliant
China RoHS 2 Directive MIIT Order No 32, 2016	No Restricted Materials Above Threshold
EU REACH Regulation (EC) No. 1907/2006	Current ECHA Candidate List: JUNE 2023 (235) Candidate List Declared Against: JUNE 2022 (224) Does not contain REACH SVHC
Halogen Content	Low Halogen - Br, Cl, F, I < 900 ppm per homogenous material. Also BFR/CFR/PVC Free
Solder Process Capability	Not applicable for solder process capability

Product Compliance Disclaimer

This information is provided based on reasonable inquiry of our suppliers and represents our current actual knowledge based on the information they provided. This information is subject to change. The part numbers that TE has identified as EU RoHS compliant have a maximum concentration of 0.1% by weight in homogenous materials for lead, hexavalent chromium, mercury, PBB, PBDE, DBP, BBP, DEHP, DIBP, and 0.01% for cadmium, or qualify for an exemption to these limits as defined in the Annexes of Directive 2011/65/EU (RoHS2). Finished electrical and electronic equipment products will be CE marked as required by Directive 2011/65/EU. Components may not be CE marked. Additionally, the part numbers that TE has identified as EU ELV compliant have a maximum concentration of 0.1% by weight in homogenous materials for lead, hexavalent chromium, and mercury, and 0.01% for cadmium, or qualify for an exemption to these limits as defined in the Annexes of Directive 2000/53/EC (ELV). Regarding the REACH Regulation, the information TE provides on SVHC in articles for this part number is based on the latest European Chemicals Agency (ECHA) 'Guidance on requirements for substances in articles' posted at this URL: <https://echa.europa.eu/guidance-documents/guidance-on-reach>

Compatible Parts



Also in the Series | AMPSEAL 16

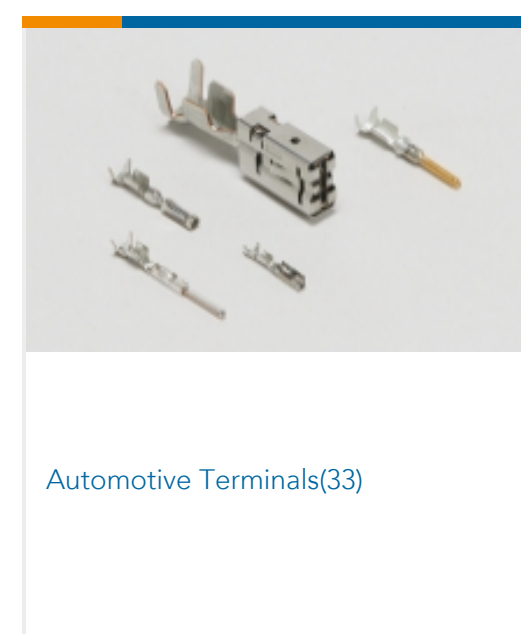
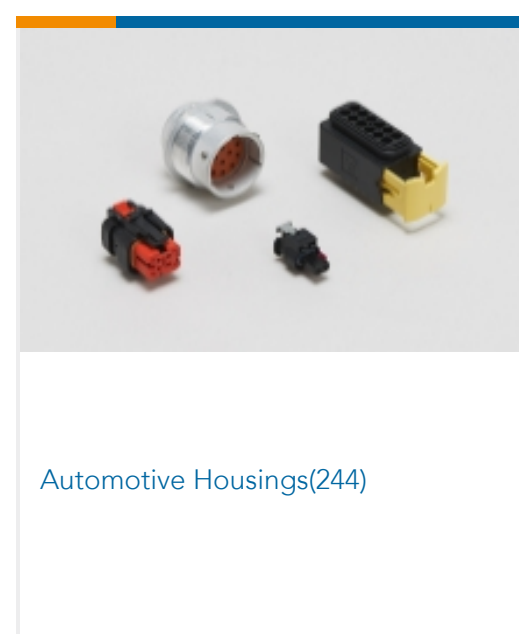
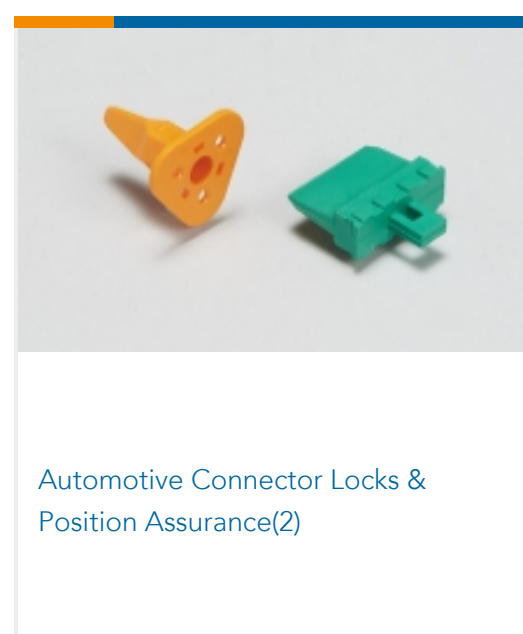
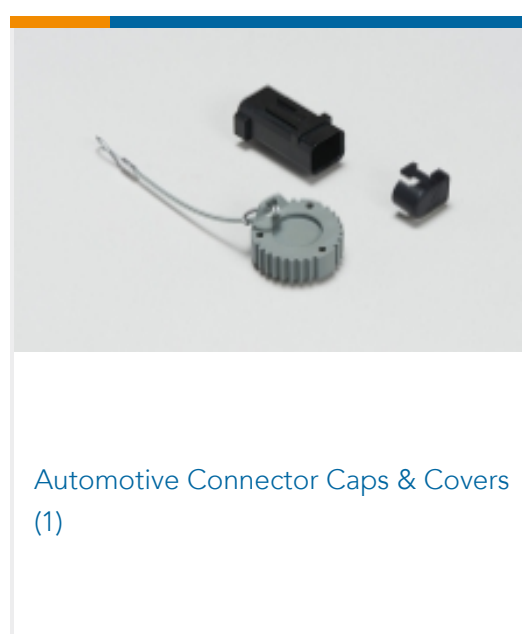



Connector Backshells(84)



Connector Seals & Cavity Plugs(4)



Data Connectivity Headers(2)



Data Connectivity Housings(3)



Other Automotive Connector Accessories(11)

Customers Also Bought



TE Part #776538-3
AMPSEAL 16 Housings



TE Part #DT04-4P-RT03
REC, 4P, GRY, 600V, 1.28V, 4A DIODE



TE Part #YHDP26-24-23SEL024
PLG, 23P, BLK, E, WTHD, 16, S

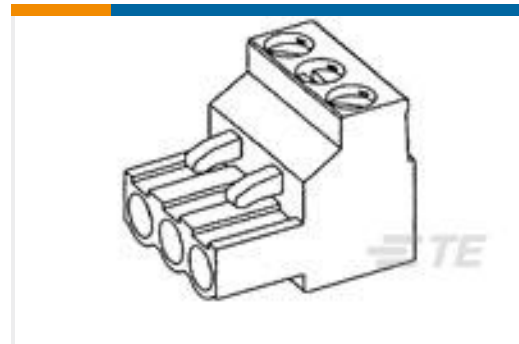

TE Part #796634-5
5 POS 5.08MM R/A PLUG, TRM BLK

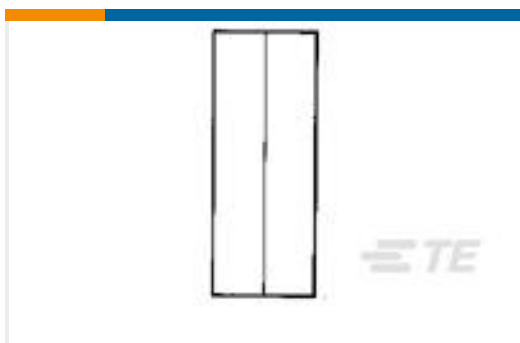

TE Part #34319
SPLICE, SOLIS PARA 6

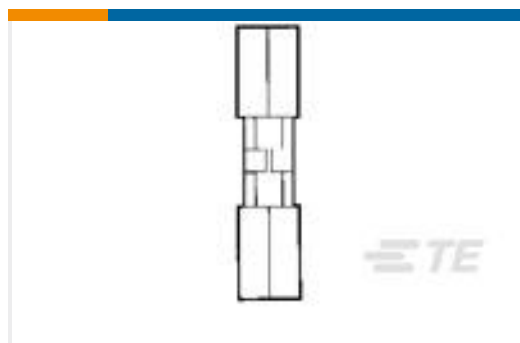

TE Part #322459
SPLICE, SOLIS BUTT STRAP 16-14

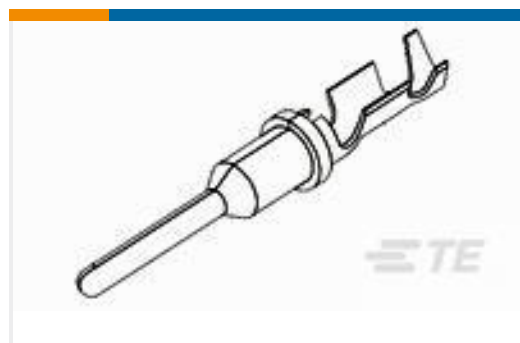

TE Part #1924463-1
PIN, SF, SIZE 16, 18-20 AWG, AU/SN



TE Part #1-1414167-0
V23134A0056X432-EV-CBOX

Documents

Product Drawings

[Backshell, AS16, 4P, 90Deg, NC12, LP, Plug](#)

English

CAD Files

[3D PDF](#)

[3D](#)

[Customer View Model](#)

[ENG_CVM_CVM_2035366-9_C.2d_dxf.zip](#)



English

Customer View Model

[ENG_CVM_CVM_2035366-9_C.3d_igs.zip](#)

English

Customer View Model

[ENG_CVM_CVM_2035366-9_C.3d_stp.zip](#)

English

By downloading the CAD file I accept and agree to the [Terms and Conditions](#) of use.

Datasheets & Catalog Pages

[ICT Terminals and Connectors Catalogue](#)

English

[CONNECTOR SELECTOR](#)

English