

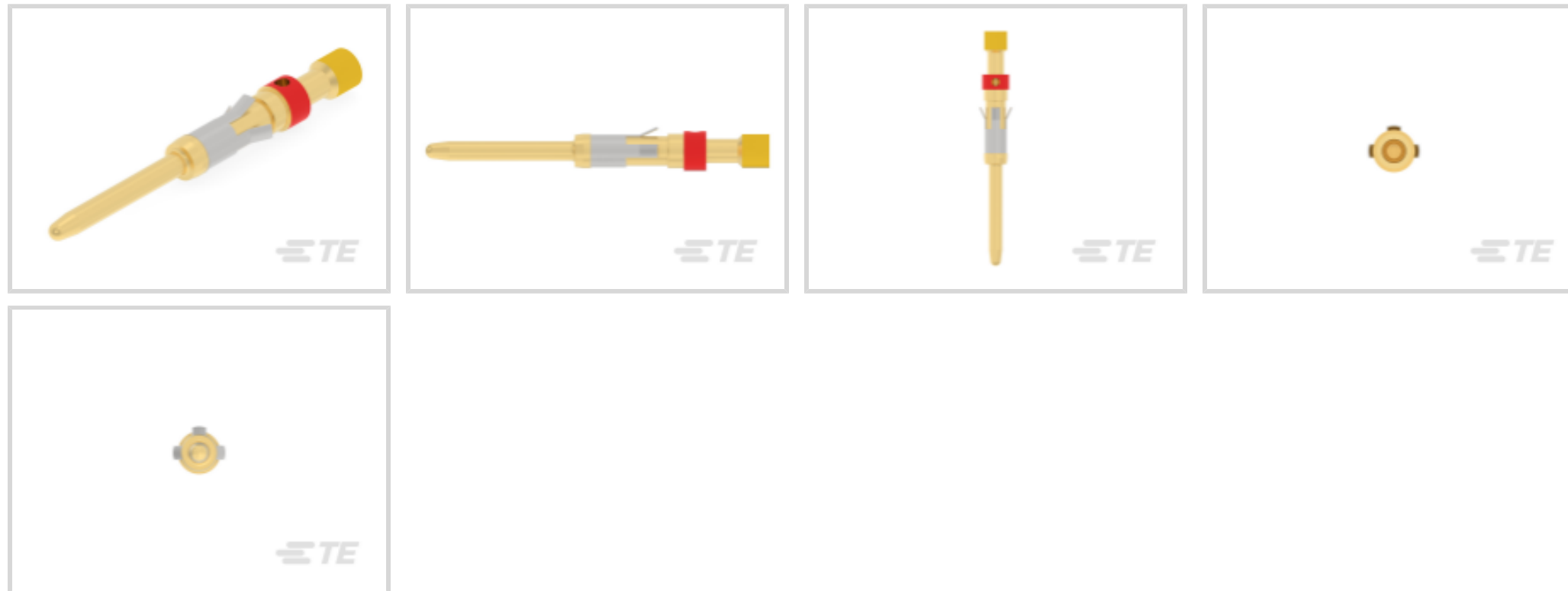

Connectors > Power Connectors > Power Contacts > Pin and Socket Contacts, Type II



Power Contact Type: **Contact**

Contact Mating Area Plating Material: **Gold**

Wire Size: **.2 – .6 mm²**

Sealable: **No**

[All Pin and Socket Contacts, Type II \(16\)](#)

Features

Product Type Features

Power Contact Type	Contact
Sealable	No
Connector & Contact Terminates To	Wire & Cable

Contact Features

Contact Size	Size 16
Contact Mating Area Plating Material	Gold
Contact Current Rating (Max)	13 A
Contact Type	Pin
Contact Retention Within Housing	With
Mating Pin Diameter	1.57 mm[.062 in]
Contact Base Material	Brass
Contact Mating Area Plating Material Thickness	.76 μm[30 μin]
Contact Mating Area Plating Material Finish	Bright
Wire Contact Termination Area Plating Thickness	.76 μm[30 μin]



Wire Contact Termination Area Plating Material	Gold
Contact Orientation	Straight
Contact Underplating Material	Nickel
Contact Underplating Material Thickness	1.27 μm[50 μin]

Termination Features

Termination Method to Wire & Cable	Crimp
------------------------------------	-------

Mechanical Attachment

Contact Retention Type Within Housing	Snap-In
Wire Insulation Support	With

Dimensions

Wire Size	.2 – .6 mm ²
Compatible Insulation Diameter Range	1.02 – 1.57 mm[.04 – .062 in]

Usage Conditions

Operating Temperature Range	-55 – 105 °C[-55 – 302 °F]
-----------------------------	----------------------------

Operation/Application

Circuit Application	Signal
---------------------	--------

Identification Marking

Contact Color Code	Yellow/Red
--------------------	------------

Packaging Features

Packaging Quantity	900
Packaging Method	Bag

Other

Power Connectors Comment	Extraction Tool No. 305183, Insertion Tool No. 200893-2 (for insulation diameters 1.78 [.07] or less)., Use turret TH502 (p/n 1-601967-6) with hand tool 601967-1.
--------------------------	--

Product Compliance

For compliance documentation, visit the product page on [TE.com](https://www.te.com)>

EU RoHS Directive 2011/65/EU	Compliant with Exemptions
EU ELV Directive 2000/53/EC	Compliant with Exemptions
China RoHS 2 Directive MIIT Order No 32, 2016	Restricted Materials Above Threshold
EU REACH Regulation (EC) No. 1907/2006	



Current ECHA Candidate List: JUNE 2023 (235)

Candidate List Declared Against: JUNE 2023 (235)

SVHC > Threshold:

Pb (2.5% in Component Part)

Article Safe Usage Statements:

Do not eat, drink or smoke when using this product. Wash thoroughly after handling. Recycle if possible and dispose of the article by following all applicable governmental regulations relevant to your geographic location.

Halogen Content

Low Halogen - Br, Cl, F, I < 900 ppm per homogenous material. Also BFR/CFR/PVC Free

Solder Process Capability

Not applicable for solder process capability

Product Compliance Disclaimer

This information is provided based on reasonable inquiry of our suppliers and represents our current actual knowledge based on the information they provided. This information is subject to change. The part numbers that TE has identified as EU RoHS compliant have a maximum concentration of 0.1% by weight in homogenous materials for lead, hexavalent chromium, mercury, PBB, PBDE, DBP, BBP, DEHP, DIBP, and 0.01% for cadmium, or qualify for an exemption to these limits as defined in the Annexes of Directive 2011/65/EU (RoHS2). Finished electrical and electronic equipment products will be CE marked as required by Directive 2011/65/EU. Components may not be CE marked. Additionally, the part numbers that TE has identified as EU ELV compliant have a maximum concentration of 0.1% by weight in homogenous materials for lead, hexavalent chromium, and mercury, and 0.01% for cadmium, or qualify for an exemption to these limits as defined in the Annexes of Directive 2000/53/EC (ELV). Regarding the REACH Regulation, the information TE provides on SVHC in articles for this part number is based on the latest European Chemicals Agency (ECHA) 'Guidance on requirements for substances in articles' posted at this URL: <https://echa.europa.eu/guidance-documents/guidance-on-reach>

Compatible Parts



TE Part # CAT-AM71-C83998C
Circular Plastic Connector, CMC Series 1



TE Part # CAT-AM71-C83998Y
One-Piece Connector, Sealed, CPC Series 1



TE Part # CAT-AM71-C83998J
Cable/Panel Mount Connector, CPC Series 1



TE Part # CAT-AM71-C83998K
Circular Connector, Environmentally Sealed, CPC Series 6



TE Part # 200893-2
INSERTION TOOL CONT



TE Part # 539972-1
EXTRACTION TOOL



TE Part # 305183
EXTRACT TOOL TYPE 2 20-16



TE Part # 601967-1
CRIMPING TOOL M22520/1-01



Also in the Series | AMP Type II

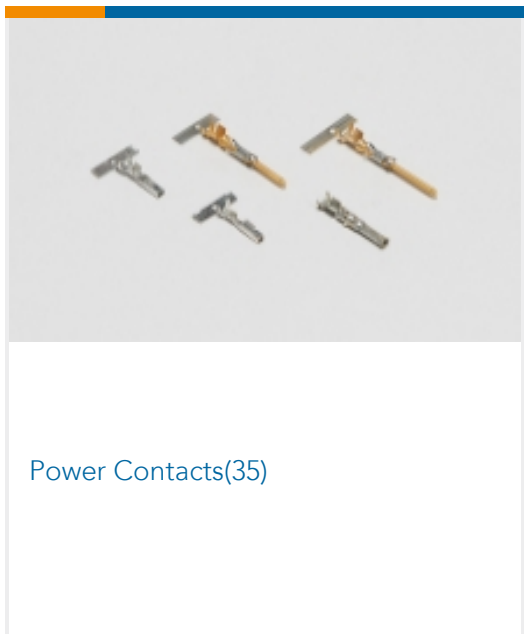
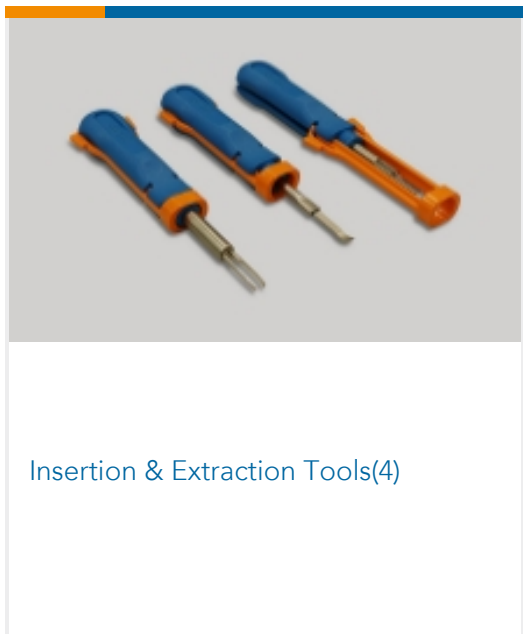

Customers Also Bought

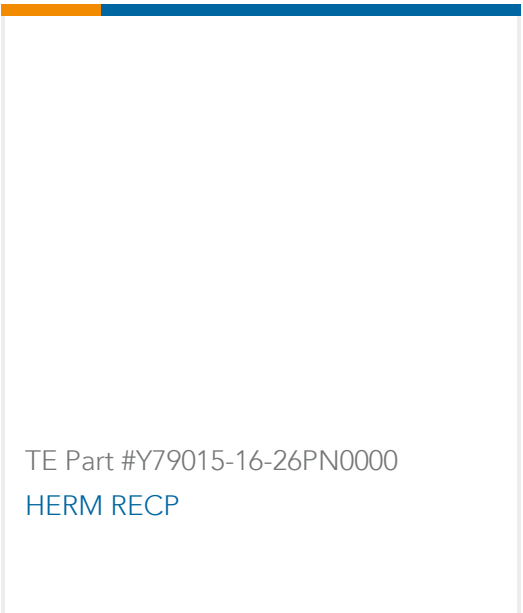
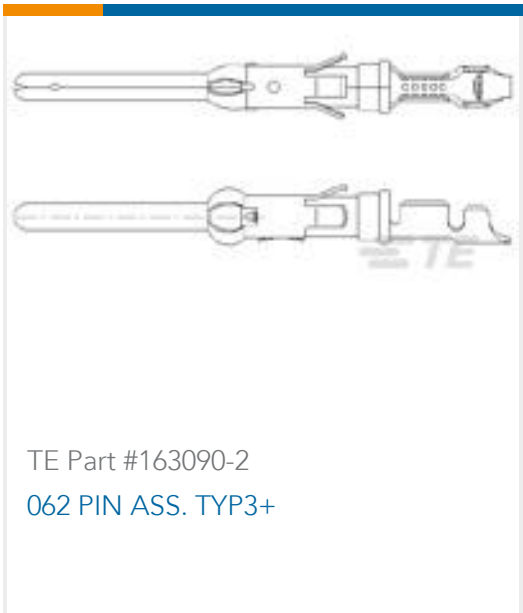
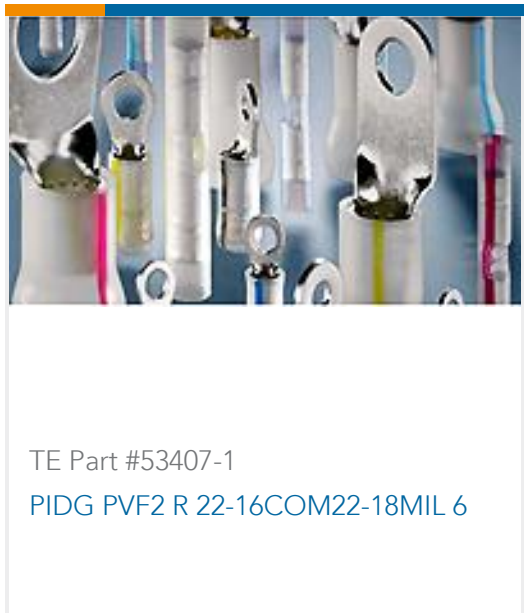



Documents

Product Drawings

[CONTACT PIN ASSY.](#)

English

CAD Files

Customer View Model

[ENG_CVM_201578-1_U.3d_igs.zip](#)

English

Customer View Model

[ENG_CVM_201578-1_U.3d_stp.zip](#)

English

Customer View Model

[ENG_CVM_201578-1_U.2d_dxf.zip](#)

English

[3D PDF](#)

English

[3D PDF](#)

3D

Customer View Model

[ENG_CVM_CVM_201578-1_AD.2d_dxf.zip](#)

English

Customer View Model

[ENG_CVM_CVM_201578-1_AD.3d_igs.zip](#)

English

Customer View Model

[ENG_CVM_CVM_201578-1_AD.3d_stp.zip](#)

English

By downloading the CAD file I accept and agree to the [Terms and Conditions](#) of use.

Datasheets & Catalog Pages

[AMP Circular Connectors for Commercial Signal & Power Applications](#)

English

[Signal Contacts](#)

English

[M_SERIES_PIN_AND_SOCKET_CONNECTORS](#)



English

Product Specifications

[Application Specification](#)

Japanese

[Application Specification](#)

English

[Type II Screw Machine Contacts](#)

Japanese

[Application Specification](#)

Japanese

Product Environmental Compliance

[MD_201578-1_01282016920_dmtec](#)

English

[MD_201578-1_01282016920_dmtec](#)

English

Instruction Sheets

[Instruction Sheet \(U.S.\)](#)

Japanese

[Instruction Sheet \(U.S.\)](#)

English

[Instruction Sheet \(U.S.\)](#)

English

[Application and Maintenance for Crimping Die Assemblies](#)

English

[Instruction Sheet \(U.S.\)](#)

English