



SFP28

TE Internal #: 2007399-5

SFP, SFP+ & zSFP+, Cage Assembly with Integrated Connector,
Data Rate (Max) 16 Gb/s, Elastomeric Gasket, SFP+, With
Lightpipe, 2 x 4

[View on TE.com >](#)

Connectors > Pluggable IO Connectors & Cages > SFP, SFP+ & zSFP+ > SFP+ Stacked Cage Assemblies

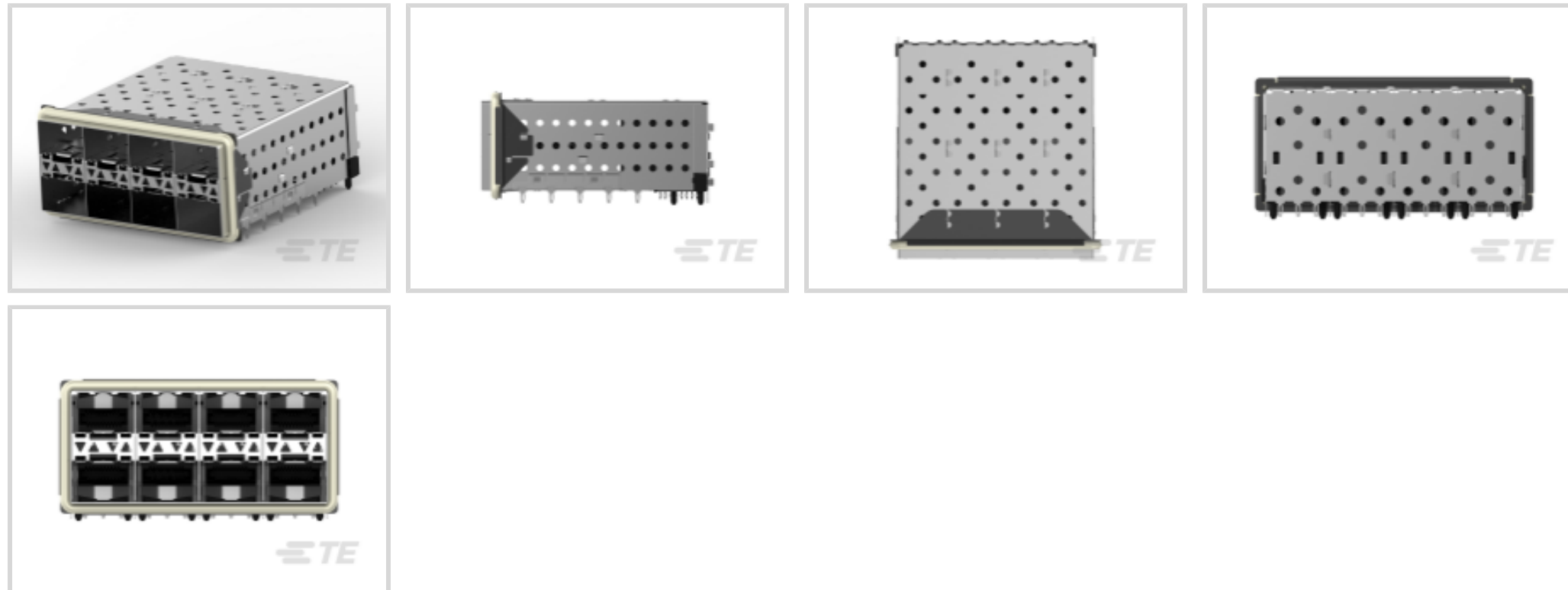

Pluggable I/O Product Type: **Cage Assembly with Integrated Connector**

Data Rate (Max): **16 Gb/s**

EMI Containment Feature Type: **Elastomeric Gasket**

Pluggable I/O Applications: **SFP+**

Lightpipe Options: **With Lightpipe**

[All SFP+ Stacked Cage Assemblies \(122\)](#)

Features

Product Type Features

Form Factor	SFP+
Cage Type	Stacked
Pluggable I/O Product Type	Cage Assembly with Integrated Connector
Lightpipe Options	With Lightpipe
Connector System	Cable-to-Board
Sealable	Yes
Connector & Contact Terminates To	Printed Circuit Board

Configuration Features

Port Matrix Configuration	2 x 4
Lightpipe Configuration	Four Triangular (Inner & Outer)
Number of Ports	8
Number of Positions	160



Electrical Characteristics

Data Rate (Max)	16 Gb/s
-----------------	---------

Contact Features

Tail Plating Material	Tin
Contact Mating Area Plating Material Thickness	.76 μ m
Contact Mating Area Plating Material	Gold or Gold Flash over Palladium Nickel

Termination Features

Termination Post & Tail Length	3 mm [.118 in]
Termination Method to Printed Circuit Board	Through Hole - Press-Fit

Mechanical Attachment

Connector Mounting Type	Board Mount
-------------------------	-------------

Housing Features

Cage Material	Nickel Silver
Centerline (Pitch)	.8 mm [.032 in]

Dimensions

PCB Thickness (Recommended)	1.5 mm [.059 in]
-----------------------------	------------------

Usage Conditions

Operating Temperature Range	-55 – 105 °C [-67 – 221 °F]
-----------------------------	-----------------------------

Operation/Application

Heat Sink Compatible	No
Pluggable I/O Applications	SFP+
Circuit Application	Signal

Industry Standards

UL Flammability Rating	UL 94V-0
------------------------	----------

Packaging Features

Packaging Method	Tray
------------------	------

Other

EMI Containment Feature Type	Elastomeric Gasket
------------------------------	--------------------

Product Compliance









[For compliance documentation, visit the product page on TE.com>](#)

EU RoHS Directive 2011/65/EU	Compliant
EU ELV Directive 2000/53/EC	Compliant
China RoHS 2 Directive MIIT Order No 32, 2016	No Restricted Materials Above Threshold
EU REACH Regulation (EC) No. 1907/2006	Current ECHA Candidate List: JUNE 2023 (235) Candidate List Declared Against: JUNE 2023 (235) Does not contain REACH SVHC
Halogen Content	Not Low Halogen - contains Br or Cl > 900 ppm.
Solder Process Capability	Not applicable for solder process capability

Product Compliance Disclaimer

This information is provided based on reasonable inquiry of our suppliers and represents our current actual knowledge based on the information they provided. This information is subject to change. The part numbers that TE has identified as EU RoHS compliant have a maximum concentration of 0.1% by weight in homogenous materials for lead, hexavalent chromium, mercury, PBB, PBDE, DBP, BBP, DEHP, DIBP, and 0.01% for cadmium, or qualify for an exemption to these limits as defined in the Annexes of Directive 2011/65/EU (RoHS2). Finished electrical and electronic equipment products will be CE marked as required by Directive 2011/65/EU. Components may not be CE marked. Additionally, the part numbers that TE has identified as EU ELV compliant have a maximum concentration of 0.1% by weight in homogenous materials for lead, hexavalent chromium, and mercury, and 0.01% for cadmium, or qualify for an exemption to these limits as defined in the Annexes of Directive 2000/53/EC (ELV). Regarding the REACH Regulation, the information TE provides on SVHC in articles for this part number is based on the latest European Chemicals Agency (ECHA) 'Guidance on requirements for substances in articles' posted at this URL: <https://echa.europa.eu/guidance-documents/guidance-on-reach>

Compatible Parts

 <p>TE Part # CAT-C11-H50626 SFP+ to SFP+ I/O Cable Assembly: 30 AWG</p>	 <p>TE Part # CAT-C11-N490333 QSFP28-Four SFP+ Cable Assembly: 30 AWG</p>	 <p>TE Part # CAT-C11-N490325 QSFP28-Four SFP+ Cable Assembly: 26 AWG</p>	 <p>TE Part # CAT-C11-N4901114 SFP28 to SFP28 Cable Assembly: 30 AWG</p>
 <p>TE Part # CAT-C11-N49011 SFP28 to SFP28 Cable Assembly: 26 AWG</p>	 <p>TE Part # CAT-Q17-N49011 QSFP56-Four SFP56 Cable Assembly: 30 AWG</p>	 <p>TE Part # CAT-Q17-N490333 QSFP56-Four SFP56 Cable Assembly: 26 AWG</p>	 <p>TE Part # 4-2821222-5 SFP56 DIRECT ATTACH CA, 2M, 30AWG</p>



TE Part # 4-2821224-5
SFP56 DIRECT ATTACH CA, 3M, 26AWG



TE Part # 1888901-1
SFP+ EMI Plug



TE Part # 1761394-1
DUST COVER, SFP, GANGED & STACKED



TE Part # 4-2334985-2
SFP56 DIRECT ATTACH CA, 1M, 32AWG



TE Part # CAT-C11-H5
SFP+ to SFP+ I/O Cable Assembly: 24 AWG



TE Part # CAT-C11-H506
SFP+ to SFP+ I/O Cable Assembly: 26 AWG



TE Part # CAT-C11-H5062
SFP+ to SFP+ I/O Cable Assembly: 28 AWG



TE Part # 2334985-2
SFP28 DIRECT ATTACH CA, 1M, 32AWG



TE Part # 2018280-3
KIT, SEATING TOOL, SFP+2x4



TE Part # 2063048-2
SFP, 2x1 EXTRACTION TOOL ASSY



TE Part # 2142970-1
CABLE ASSY, MICRO SFP+ TO STD SFP+, 0.5M



TE Part # 2142970-2
CABLE ASSY, MICRO SFP+ TO STD SFP+, 1M

Customers Also Bought



TE Part #3-1461491-3
PCN-112D3MHZ,000



TE Part #5353929-1
Std USB Type A, R/A, SMT, Offset, Panel



TE Part #2-406549-4
IMJ,1X1,PNL GRD,LED(Y/G), S



TE Part #2170088-1
ZSFP+ Connector,30u"

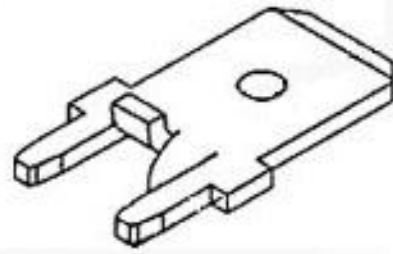

TE Part #1217167-1
250 FASTON,PCB TAB,TCBR



TE Part #2291634-1
SFP+ 1X1 CAGE ASSY, PF,WITH HEATSINK



TE Part #2308171-1
ZQSFP+ CAGE& CONN 2X2, EMI SPRING, BTB



TE Part #7-1419111-9
PT570006

Documents



Product Drawings

[SFP+assy 2x4 Gasket 4 Lp Sn](#)

English

CAD Files

[3D PDF](#)

3D

Customer View Model

[ENG_CVM_CVM_2007399-5_F.2d_dxf.zip](#)

English

Customer View Model

[ENG_CVM_CVM_2007399-5_F.3d_igs.zip](#)

English

Customer View Model

[ENG_CVM_CVM_2007399-5_F.3d_stp.zip](#)

English

By downloading the CAD file I accept and agree to the [Terms and Conditions](#) of use.

Datasheets & Catalog Pages

[1773408-1 Pluggable Input/Output Solutions catalog - SFP+ section](#)

English

[SFP+ Product Family: Cages, Connectors, Cable Assemblies 4-1773449-5](#)

English

[4-1773455-3 - Quick Reference Guide SFP+ Solutions](#)

English

Product Specifications

[Application Specification](#)

English

Product Environmental Compliance

[Product Compliance Document](#)

English

[Product Compliance Document](#)

English

Instruction Sheets

[Instruction Sheet \(U.S.\)](#)

English

[Instruction Sheet \(U.S.\)](#)

English
