

2-964302-1 ✓ ACTIVE

AMP | Timer Connector System

TE Internal #: 2-964302-1

Automotive Terminals, Tab, Mating Tab Width 2.8 mm [.11 in], Tab Thickness .8 mm [.031 in], 17 – 13 AWG Wire Size, Timer Connector System

[View on TE.com >](#)



Terminals & Splices > Automotive Terminals > TIMER, RECEPTACLE AND TAB



Terminal Type: **Tab**

Mating Tab Width: **2.8 mm [.11 in]**

Mating Tab Thickness: **.8 mm [.031 in]**

Terminal Transmits: **25 – 40 A (Power)**

Wire Size: **17 – 13 AWG**

[All TIMER, RECEPTACLE AND TAB \(348\)](#)

## Features

### Product Type Features

Sealable	Yes
Primary Locking Feature	Locking Lance

### Body Features

Terminal Seal Type	Single Wire Seal (SWS)
--------------------	------------------------

### Contact Features

Contact Size	2.8mm
Contact Fabrication	Stamped & Formed
Wire Contact Termination Area Plating Material	Tin
Typical Current Rating	30 A
Crimp Type	F-Crimp
Terminal Type	Tab
Mating Tab Width	2.8 mm[.11 in]
Mating Tab Thickness	.8 mm[.031 in]
Interface Plating	Tin (Sn)

### Termination Features

Termination Method to Wire & Cable	Crimp
Product Terminates To	Wire



### Dimensions

Compatible Insulation Diameter Range	3.4 mm[.134 in]
Wire Size	1 – 2.5 mm <sup>2</sup>
Wire Size Search	13 AWG, 14 AWG, 15 AWG, 16 AWG, 17 AWG
Tab Length	25 mm[.98 in]

### Usage Conditions

Insulation Option	Uninsulated
Operating Temperature (Max)	130 °C[266 °F]
Operating Temperature Range	-40 – 130 °C[-40 – 266 °F]

### Operation/Application

Compatible With Wire Base Material	Copper
------------------------------------	--------

### Industry Standards

Agency/Standard	IEC 664/664A (DIN VDE 0110)
-----------------	-----------------------------

### Packaging Features

Packaging Quantity	3300
Packaging Method	Reel

### Other

Terminal Transmits	25 – 40 A (Power)
--------------------	-------------------

### Product Compliance

[For compliance documentation, visit the product page on TE.com>](#)

EU RoHS Directive 2011/65/EU	Compliant
EU ELV Directive 2000/53/EC	Compliant
China RoHS 2 Directive MIIT Order No 32, 2016	No Restricted Materials Above Threshold
EU REACH Regulation (EC) No. 1907/2006	Current ECHA Candidate List: JUNE 2023 (235) Candidate List Declared Against: JUNE 2023 (235) Does not contain REACH SVHC
Halogen Content	Low Halogen - Br, Cl, F, I < 900 ppm per homogenous material. Also BFR/CFR/PVC Free
Solder Process Capability	Not applicable for solder process capability

Product Compliance Disclaimer

This information is provided based on reasonable inquiry of our suppliers and represents our current actual knowledge based on the information they provided. This information is subject to change. The part numbers that TE has identified as EU RoHS compliant have a maximum concentration of 0.1% by weight in homogenous materials for lead, hexavalent chromium, mercury, PBB, PBDE, DBP, BBP, DEHP, DIBP, and 0.01% for cadmium, or qualify for an exemption to these limits as defined in the Annexes of Directive 2011/65/EU (RoHS2). Finished electrical and electronic equipment products will be CE marked as required by Directive 2011/65/EU. Components may not be CE marked. Additionally, the part numbers that TE has identified as EU ELV compliant have a maximum concentration of 0.1% by weight in homogenous materials for lead, hexavalent chromium, and mercury, and 0.01% for cadmium, or qualify for an exemption to these limits as defined in the Annexes of Directive 2000/53/EC (ELV). Regarding the REACH Regulation, the information TE provides on SVHC in articles for this part number is based on the latest European Chemicals Agency (ECHA) 'Guidance on requirements for substances in articles' posted at this URL: <https://echa.europa.eu/guidance-documents/guidance-on-reach>

## Compatible Parts



TE Part # CAT-AM705-CH8172  
AMP MCP, SEALED CONNECTOR HOUSING



TE Part # CAT-T4827-CH8172  
Timer Connector Housing



TE Part # 4-1579007-3  
EXTRACTION TOOL KIT



TE Part # 1-1579007-6  
EXTRACTION TOOL



TE Part # 963293-1  
SEALING F JPT+2,8

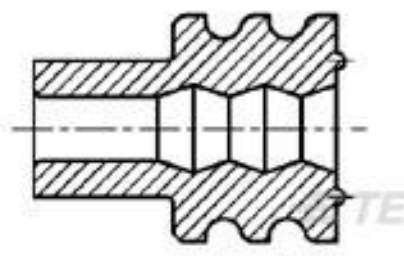

TE Part # 963292-1  
WIRE SEALING 2,2



TE Part # 828905-1  
SINGLE-WIRE-SEAL(5MM HOLE)



TE Part # 2305570-1  
Strip Terminal Cutter-Side Feed-No Crimp



TE Part # 1-284844-0  
12 POS MCP HYBRID MALE CONNECTOR



TE Part # 1579008-9  
INSERTION TOOL



TE Part # 2151063-1  
OCEAN\_2.0\_APPLICATION-S-100F165O



TE Part # 2151063-2  
OCEAN\_2.0\_APPLICATION-S-100F165O

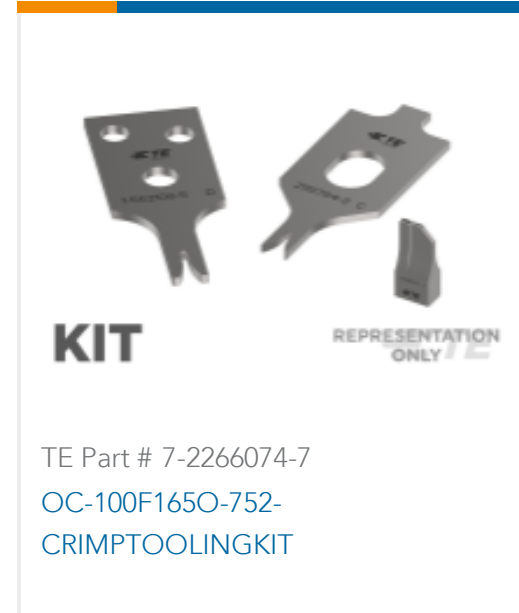

## Also in the Series | Timer Connector System

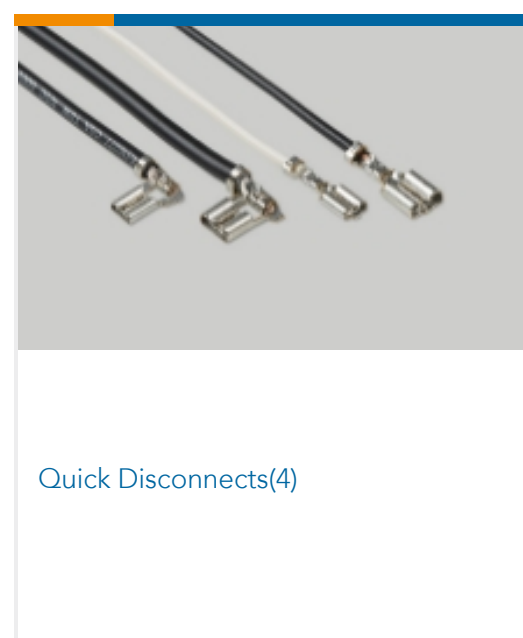
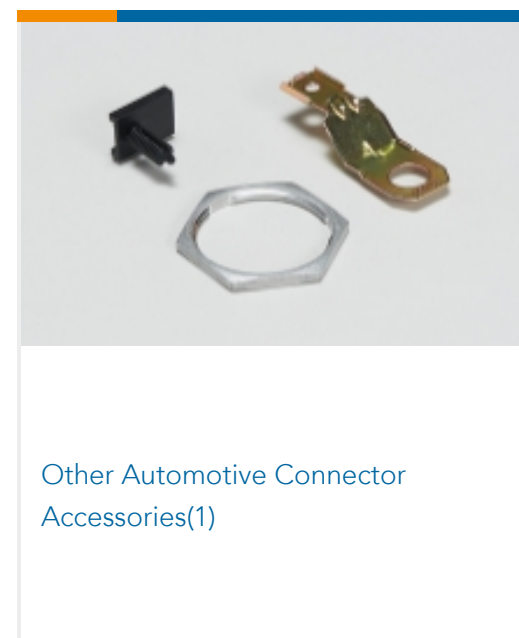
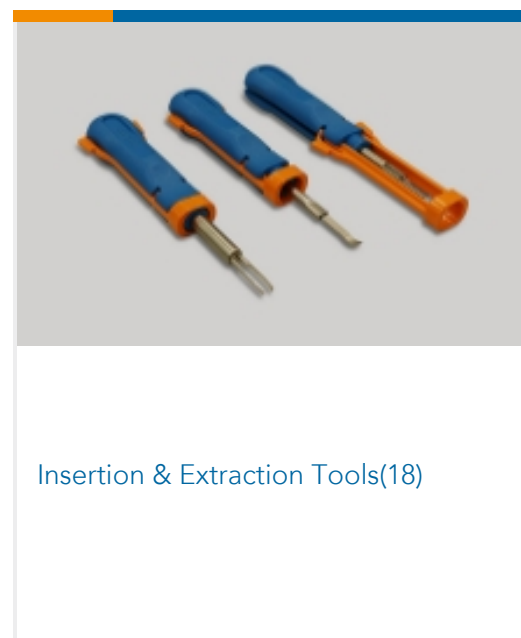
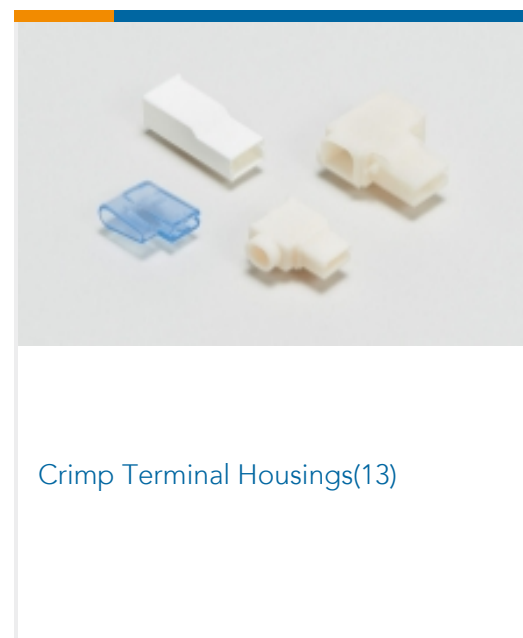
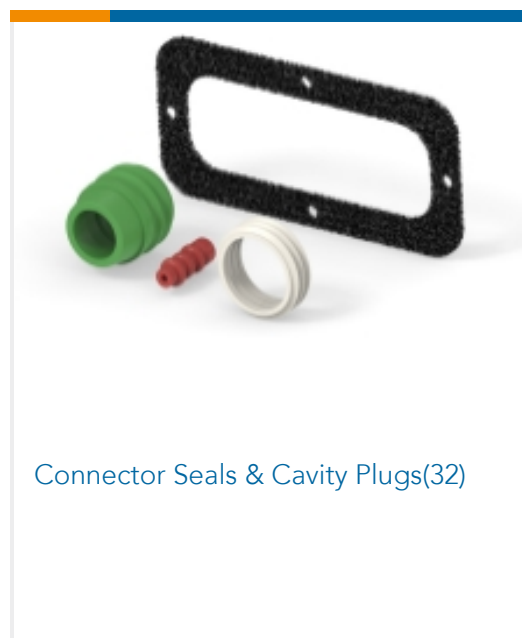
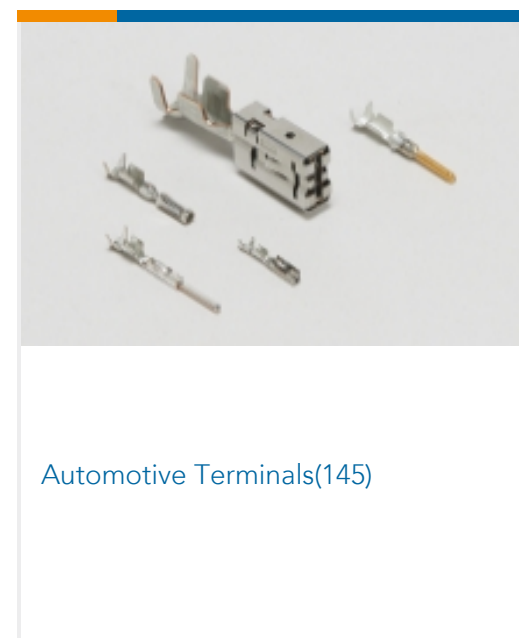
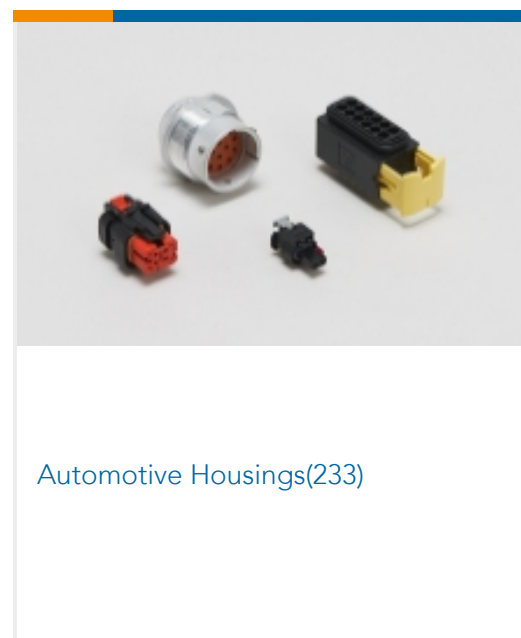
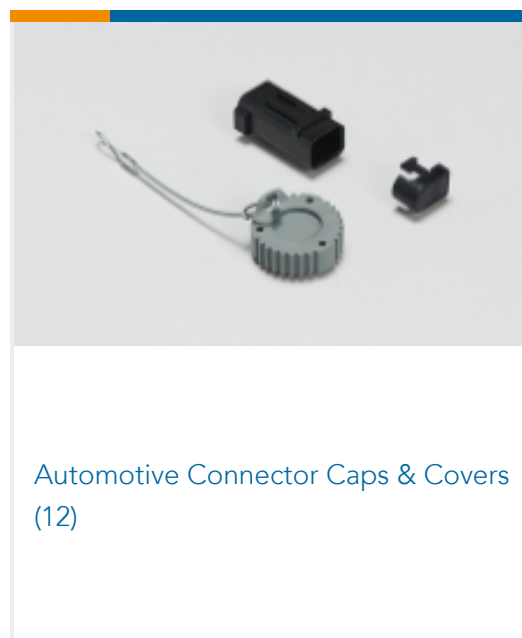

## Customers Also Bought



## Documents

### Product Drawings

[TAB A 2.8x0.8 CONTACT CF SWS Sn](#)

English

[TAB A 2.8x0.8 CONTACT CF SWS Sn](#)

English

### CAD Files

Customer View Model

[ENG\\_CVM\\_CVM\\_2-964302-1\\_C.2d\\_dxf.zip](#)

English

3D PDF

3D

Customer View Model

[ENG\\_CVM\\_CVM\\_2-964302-1\\_C.3d\\_igs.zip](#)

English

Customer View Model

[ENG\\_CVM\\_CVM\\_2-964302-1\\_C.3d\\_stp.zip](#)

English

By downloading the CAD file I accept and agree to the [Terms and Conditions](#) of use.



---

**Datasheets & Catalog Pages**

**Timer Interconnection System**

English

---

**Product Specifications**

**Application Specification**

German

**Application Specification**

English

**Application Specification**

English

**Application Specification**

English