

2-927770-1 ✓ ACTIVE

AMP | Junior Power Timer

TE Internal #: 2-927770-1

Automotive Terminals, Receptacle, Mating Tab Width 2.8 mm [.11 in], Tab Thickness .8 mm [.031 in], 20 – 17 AWG Wire Size, Junior Power Timer

[View on TE.com >](#)



Terminals & Splices > Automotive Terminals > TIMER, RECEPTACLE AND TAB

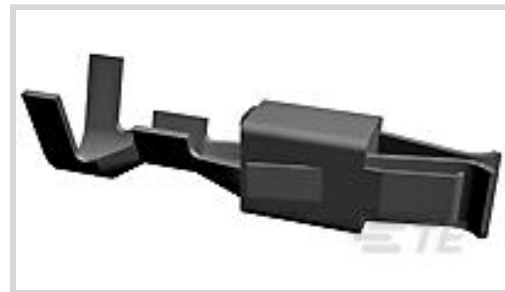

Terminal Type: **Receptacle**

Mating Tab Width: **2.8 mm [.11 in]**

Mating Tab Thickness: **.8 mm [.031 in]**

Terminal Transmits: **25 – 40 A (Power)**

Wire Size: **20 – 17 AWG**

[All TIMER, RECEPTACLE AND TAB \(348\)](#)

## Features

### Product Type Features

Receptacle Style	180°
Sealable	Yes
Primary Locking Feature	Locking Lance

### Body Features

Terminal Seal Type	Single Wire Seal (SWS)
--------------------	------------------------

### Contact Features

Contact Size	2.8mm
Contact Fabrication	Stamped & Formed
Wire Contact Termination Area Plating Material	Tin
Typical Current Rating	30 A
Crimp Type	F-Crimp
Terminal Type	Receptacle
Mating Tab Width	2.8 mm[.11 in]
Mating Tab Thickness	.8 mm[.031 in]
Interface Plating	Gold (Au)

### Termination Features

Termination Method to Wire & Cable	Crimp
------------------------------------	-------



Product Terminates To	Wire
-----------------------	------

### Dimensions

Compatible Insulation Diameter Range	3.4 mm[.134 in]
Wire Size	.5 – 1 mm <sup>2</sup>
Wire Size Search	17 AWG, 18 AWG, 19 AWG, 20 AWG
Tab Length	18.8 mm[.74 in]

### Usage Conditions

Insulation Option	Uninsulated
Operating Temperature (Max)	150 °C[302 °F]
Operating Temperature Range	-40 – 150 °C[-40 – 302 °F]

### Operation/Application

Compatible With Wire Base Material	Copper
------------------------------------	--------

### Industry Standards

Agency/Standard	DIN 72 551 Part 6, DIN ISO 6722 part 3
-----------------	--

### Packaging Features

Packaging Quantity	3750
Packaging Method	Reel

### Other

Terminal Transmits	25 – 40 A (Power)
--------------------	-------------------

## Product Compliance

[For compliance documentation, visit the product page on TE.com>](#)

EU RoHS Directive 2011/65/EU	Compliant
EU ELV Directive 2000/53/EC	Compliant
China RoHS 2 Directive MIIT Order No 32, 2016	No Restricted Materials Above Threshold
EU REACH Regulation (EC) No. 1907/2006	Current ECHA Candidate List: JUNE 2023 (235) Candidate List Declared Against: JUNE 2023 (235) Does not contain REACH SVHC
Halogen Content	Low Halogen - Br, Cl, F, I < 900 ppm per homogenous material. Also BFR/CFR/PVC Free
Solder Process Capability	Not applicable for solder process capability

Product Compliance Disclaimer

This information is provided based on reasonable inquiry of our suppliers and represents our current actual knowledge based on the information they provided. This information is subject to change. The part numbers that TE has identified as EU RoHS compliant have a maximum concentration of 0.1% by weight in homogenous materials for lead, hexavalent chromium, mercury, PBB, PBDE, DBP, BBP, DEHP, DIBP, and 0.01% for cadmium, or qualify for an exemption to these limits as defined in the Annexes of Directive 2011/65/EU (RoHS2). Finished electrical and electronic equipment products will be CE marked as required by Directive 2011/65/EU. Components may not be CE marked. Additionally, the part numbers that TE has identified as EU ELV compliant have a maximum concentration of 0.1% by weight in homogenous materials for lead, hexavalent chromium, and mercury, and 0.01% for cadmium, or qualify for an exemption to these limits as defined in the Annexes of Directive 2000/53/EC (ELV). Regarding the REACH Regulation, the information TE provides on SVHC in articles for this part number is based on the latest European Chemicals Agency (ECHA) 'Guidance on requirements for substances in articles' posted at this URL: <https://echa.europa.eu/guidance-documents/guidance-on-reach>

## Compatible Parts



TE Part # CAT-T4827-CH8172  
Timer Connector Housing



TE Part # 4-1579007-3  
EXTRACTION TOOL KIT



TE Part # 1-1579007-6  
EXTRACTION TOOL



TE Part # 2305570-1  
Strip Terminal Cutter-Side Feed-No Crimp



TE Part # 828904-1  
SINGLE WIRE SEAL FOR J.P.T.CON



TE Part # 1-1743059-2  
MT-2/JPT SLD 36P PLUG ASSY BLK



TE Part # 2151191-1  
OCEAN\_2.0\_APPLICATIONATOR-S-080F1600



TE Part # 2151191-2  
OCEAN\_2.0\_APPLICATIONATOR-S-080F1600



TE Part # 5-2151191-1  
OCEAN\_2.0\_APPLICATIONATOR-S-080F1600



TE Part # 5-2151191-2  
OCEAN\_2.0\_APPLICATIONATOR-S-080F1600



TE Part # 7-2151191-1  
OCEAN\_2.0\_APPLICATIONATOR-S-080F1600



TE Part # 7-2151191-2  
OCEAN\_2.0\_APPLICATIONATOR-S-080F1600



**KIT**

REPRESENTATION ONLY

TE Part # 7-2151191-7  
OCEAN\_2.0\_SPARE\_PART\_KIT-080F160O



**KIT**

REPRESENTATION ONLY

TE Part # 7-2266070-7  
OC-080F160O-CRIMPTOOLINGKIT



TE Part # 2-2151191-1  
OCEAN\_2.0\_APPLICATOR-S-080F160O



TE Part # 2-2151191-2  
OCEAN\_2.0\_APPLICATOR-S-080F160O



TE Part # 368000-2  
J-P-T 3P ASS'Y FOR CPS SENSOR



TE Part # 368354-2  
JPT 2P ASSY FOR CLIP BLUE



TE Part # 368354-3  
JPT 2P ASSY FOR CLIP GREEN



TE Part # 368354-4  
JPT 2P ASSY FOR CLIP BROWN

## Also in the Series | Junior Power Timer



Automotive Connector Caps & Covers (5)



Automotive Housings(252)



Automotive Terminals(86)



Busbars & Terminals(1)



Connector Seals & Cavity Plugs(10)



Insertion & Extraction Tools(8)



Module Components(6)



Other Automotive Connector Accessories(1)

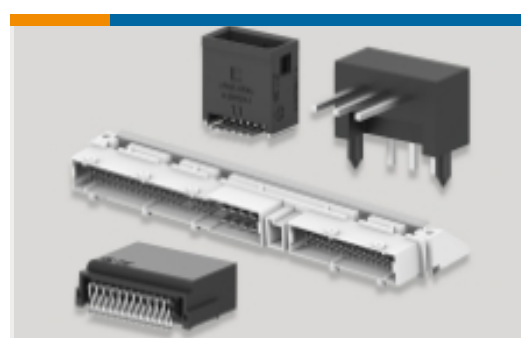

PCB Headers & Receptacles(1)

## Customers Also Bought



TE Part #1544551-1  
CONNECTOR 5V 6.35



TE Part #2109102-2  
MOS SLD 4P CAP HSG



TE Part #1-927772-1  
TIMER, RECEPTACLE AND TAB



TE Part #2109005-3  
060 TAB(M) CONT



TE Part #347707-1  
0.5MM CABLE SEAL HC SILIC

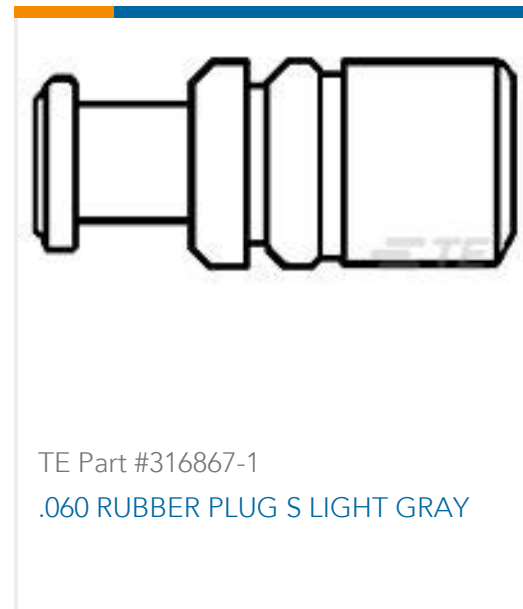

TE Part #316867-1  
.060 RUBBER PLUG S LIGHT GRAY

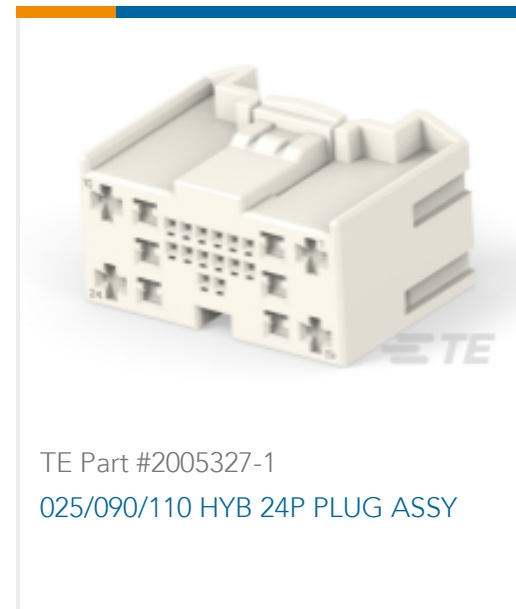

TE Part #2005327-1  
025/090/110 HYB 24P PLUG ASSY



TE Part #2005375-2  
MCON 1.2MM SLD 5P PLUG ASSY A  
BLK

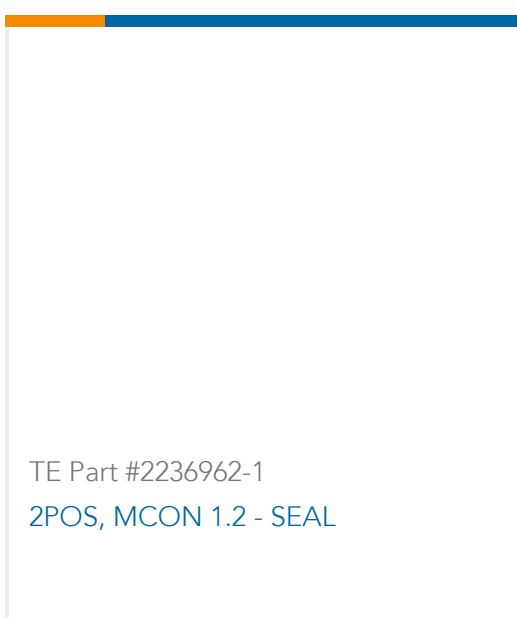

TE Part #2236962-1  
2POS, MCON 1.2 - SEAL

## Documents

### Product Drawings

[JPT REC 2.8 Contact SWS Au](#)

English

[JPT REC 2.8 Contact SWS Au](#)

English

### CAD Files

Customer View Model

[ENG\\_CVM\\_2-927770-1\\_A9.3d\\_igs.zip](#)

English

Customer View Model

[ENG\\_CVM\\_2-927770-1\\_A9.3d\\_stp.zip](#)

English

Customer View Model

[ENG\\_CVM\\_2-927770-1\\_A9.2d\\_dxf.zip](#)

English

[3D PDF](#)

English

By downloading the CAD file I accept and agree to the [Terms and Conditions](#) of use.



---

**Datasheets & Catalog Pages**

**Timer Interconnection System**

English

---

**Product Specifications**

**Application Specification**

German

**Application Specification**

English

**Application Specification**

English