



SL-156

TE Internal #: 2-640251-4

Housing, Receptacle, Wire-to-Board, 24 Position, .156 in [3.96 mm]

Centerline, Crimp, 1 Row, Natural, Wire & Cable, Power & Signal,

SL-156

[View on TE.com >](#)

Connectors > PCB Connectors > Wire-to-Board Connectors > Wire-to-Board Connector Assemblies & Housings >

Receptacle Housing: Wire-to-Board, no Mating Alignment, SL 156



Connector Product Type: **Housing**

Connector & Housing Type: **Receptacle**

Connector System: **Wire-to-Board**

Number of Positions: **24**

Centerline (Pitch): **3.96 mm [.156 in]**

[All Receptacle Housing: Wire-to-Board, no Mating Alignment, SL 156 \(27\)](#)

Features

Product Type Features

Connector Product Type	Housing
Connector & Housing Type	Receptacle
Connector System	Wire-to-Board
Sealable	No
Connector & Contact Terminates To	Wire & Cable

Configuration Features

Number of Positions	24
Number of Rows	1

Electrical Characteristics

Operating Voltage	250 VAC
-------------------	---------

Body Features

--	--



Primary Product Color	Natural
-----------------------	---------

Contact Features

Contact Retention Within Housing	Without
Contact Layout	Inline
Contact Type	Socket
Contact Current Rating (Max)	6.5 A

Termination Features

Termination Method to Wire & Cable	Crimp
------------------------------------	-------

Mechanical Attachment

Strain Relief	Without
PCB Mount Alignment	Without
Panel Mount Feature	Without
PCB Mount Retention	Without
Mating Retention	Without
Connector Mounting Type	Cable Mount (Free-Hanging)

Housing Features

Housing Entry Configuration	Left End Open
Housing Material	Nylon - GF
Centerline (Pitch)	3.96 mm [.156 in]

Dimensions

	3.746 in
Connector Height	6.35 mm
Wire Size	.0509 – .823 mm ²

Usage Conditions

Operating Temperature Range	-55 – 105 °C [-67 – 221 °F]
-----------------------------	-----------------------------

Operation/Application

Circuit Application	Power & Signal
---------------------	----------------

Industry Standards

Agency/Standard	CSA, UL
UL Flammability Rating	UL 94V-0

Packaging Features



Packaging Quantity	1
Packaging Method	Package

Other

Discrete Wire Connector Comment	Unit Accepts 1.14[.045] Square or Round Post, Accepts Keying Plug 640254-1 and 640255-1
---------------------------------	---

Product Compliance

[For compliance documentation, visit the product page on TE.com>](#)

EU RoHS Directive 2011/65/EU	Compliant
EU ELV Directive 2000/53/EC	Compliant
China RoHS 2 Directive MIIT Order No 32, 2016	No Restricted Materials Above Threshold
EU REACH Regulation (EC) No. 1907/2006	Current ECHA Candidate List: JUNE 2023 (235) Candidate List Declared Against: JUNE 2023 (235) Does not contain REACH SVHC
Halogen Content	Low Halogen - Br, Cl, F, I < 900 ppm per homogenous material. Also BFR/CFR/PVC Free
Solder Process Capability	Not applicable for solder process capability

Product Compliance Disclaimer

This information is provided based on reasonable inquiry of our suppliers and represents our current actual knowledge based on the information they provided. This information is subject to change. The part numbers that TE has identified as EU RoHS compliant have a maximum concentration of 0.1% by weight in homogenous materials for lead, hexavalent chromium, mercury, PBB, PBDE, DBP, BBP, DEHP, DIBP, and 0.01% for cadmium, or qualify for an exemption to these limits as defined in the Annexes of Directive 2011/65/EU (RoHS2). Finished electrical and electronic equipment products will be CE marked as required by Directive 2011/65/EU. Components may not be CE marked. Additionally, the part numbers that TE has identified as EU ELV compliant have a maximum concentration of 0.1% by weight in homogenous materials for lead, hexavalent chromium, and mercury, and 0.01% for cadmium, or qualify for an exemption to these limits as defined in the Annexes of Directive 2000/53/EC (ELV). Regarding the REACH Regulation, the information TE provides on SVHC in articles for this part number is based on the latest European Chemicals Agency (ECHA) 'Guidance on requirements for substances in articles' posted at this URL: <https://echa.europa.eu/guidance-documents/guidance-on-reach>

Compatible Parts



Also in the Series | SL-156

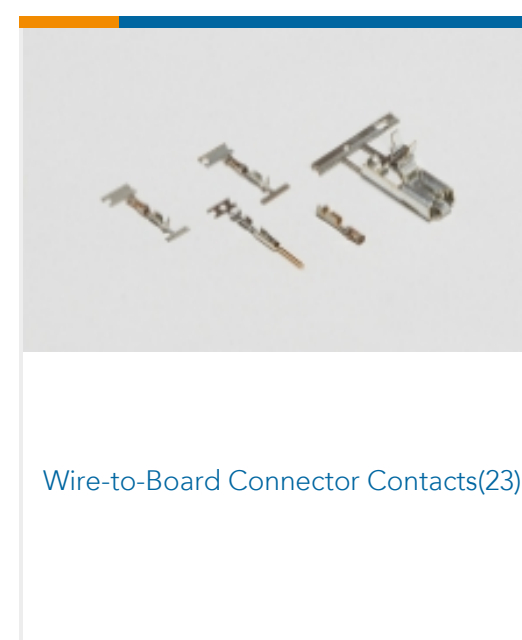
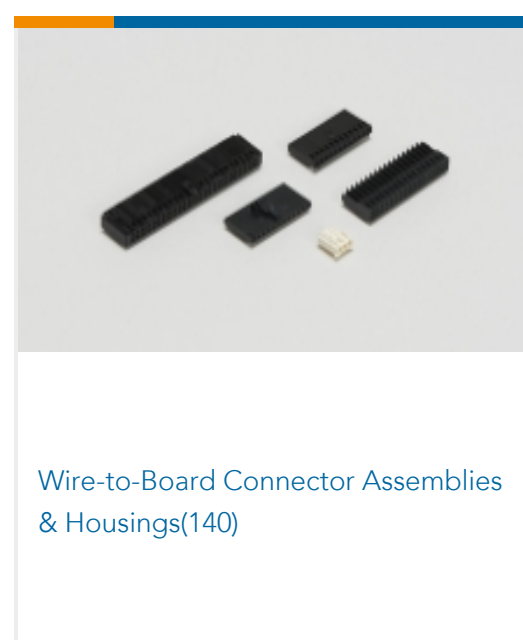
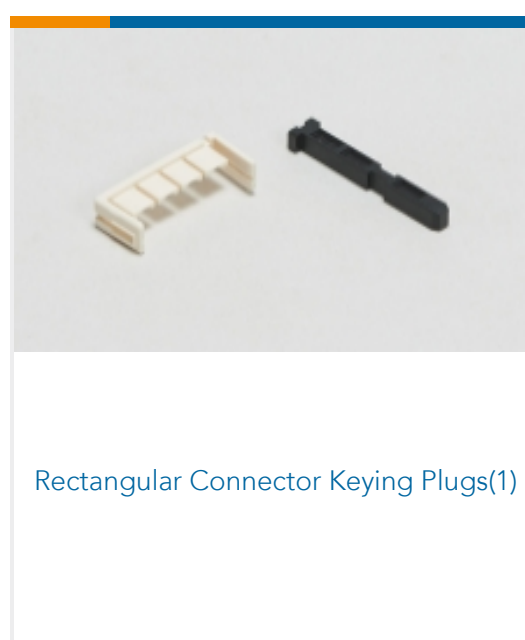
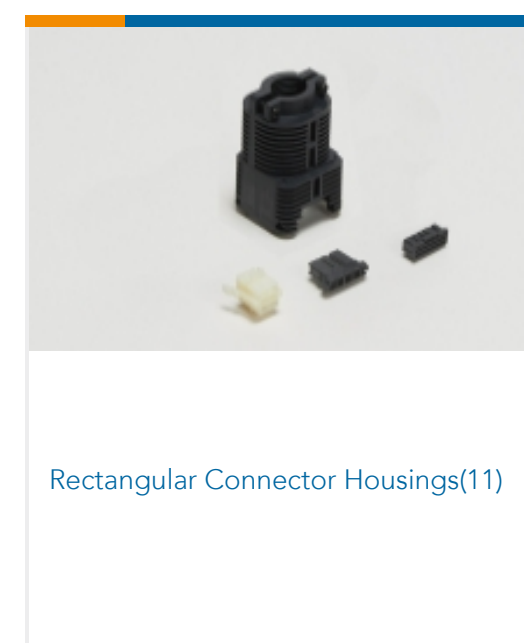
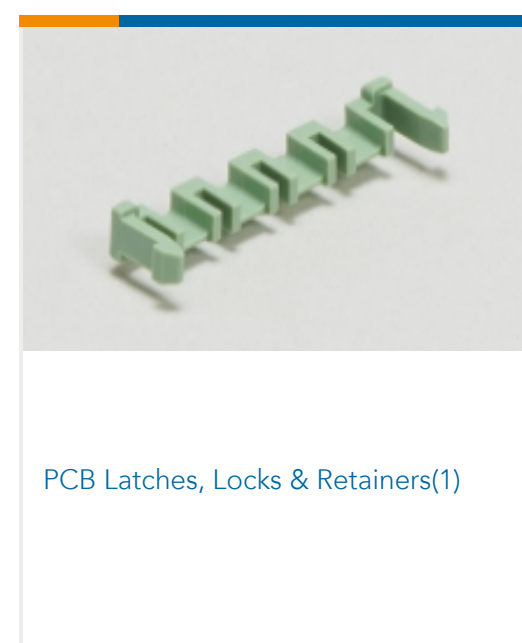
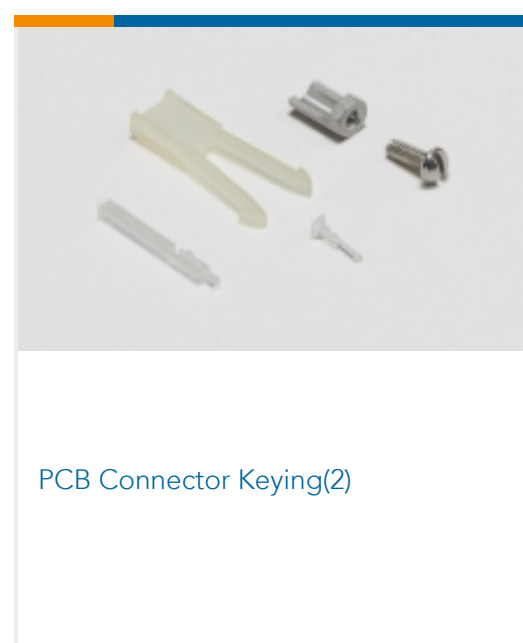
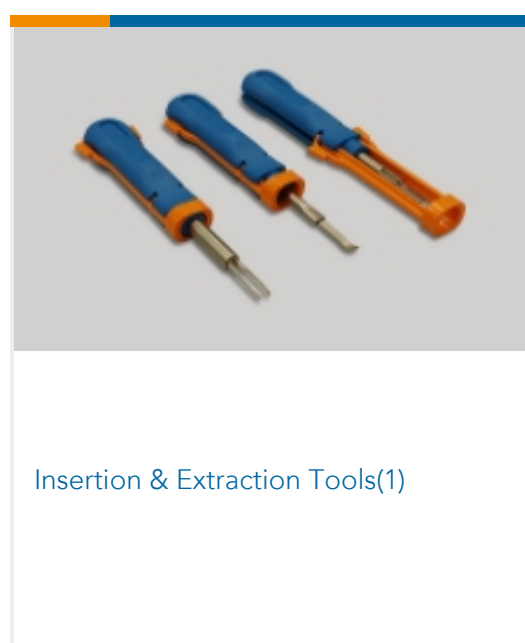

Customers Also Bought

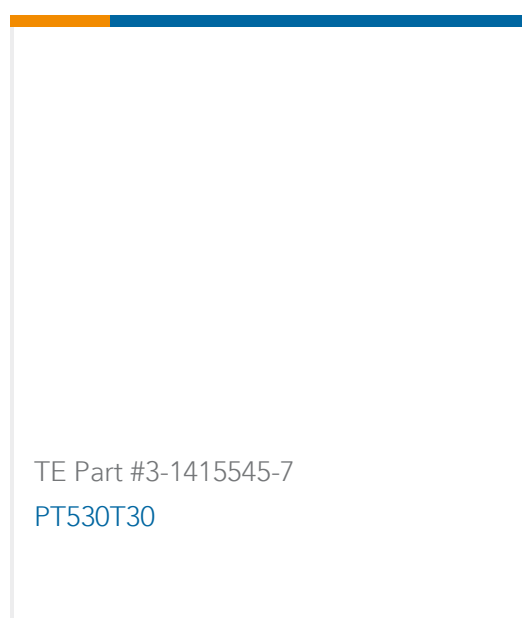
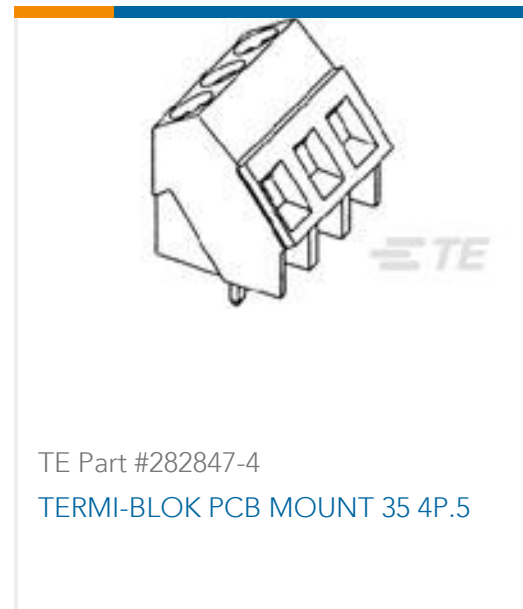
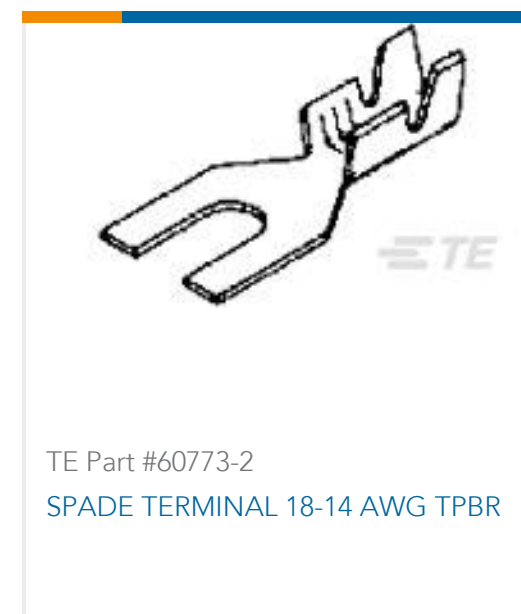

Documents

Product Drawings

24P SL156 HSG W/O LCK RAMP

English

CAD Files

3D PDF

3D

Customer View Model

[ENG_CVM_CVM_2-640251-4_AL_c-2-640251-4-al.2d_dxf.zip](#)

English

Customer View Model

[ENG_CVM_CVM_2-640251-4_AL_c-2-640251-4-al.3d_igs.zip](#)

English

Customer View Model

[ENG_CVM_CVM_2-640251-4_AL_c-2-640251-4-al.3d_stp.zip](#)

English

By downloading the CAD file I accept and agree to the [Terms and Conditions](#) of use.

Product Specifications



Application Specification

English

Product Environmental Compliance

TE Material Declaration

English

Agency Approvals

UL Report

English