

2-535542-4 ✓ ACTIVE

AMPMODU | Modu Connector System

TE Internal #: 2-535542-4

PCB Mount Receptacle, Vertical, Board-to-Board, 48 Position, 2.54 mm [.1 in] Centerline, Gold, Through Hole - Solder, Signal, Modu Connector System

[View on TE.com >](#)



Connectors > PCB Connectors > PCB Headers & Receptacles

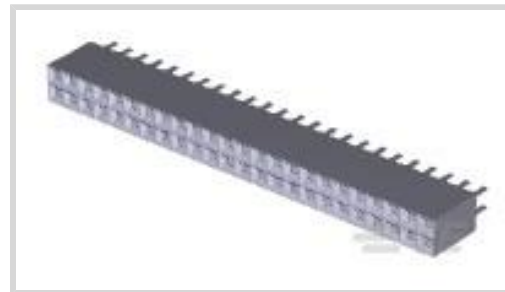

PCB Connector Assembly Type: **PCB Mount Receptacle**

PCB Mount Orientation: **Vertical**

Connector System: **Board-to-Board**

Number of Positions: **48**

Number of Rows: **2**

Features

Product Type Features

Applied Pressure	Standard
PCB Connector Assembly Type	PCB Mount Receptacle
Connector System	Board-to-Board
Sealable	No
Connector & Contact Terminates To	Printed Circuit Board

Configuration Features

Stackable	Yes
PCB Mount Orientation	Vertical
Number of Positions	48
Number of Rows	2
Board-to-Board Configuration	Parallel

Electrical Characteristics

Dielectric Withstanding Voltage (Max)	750 VAC
Insulation Resistance	5000 MΩ
Operating Voltage	333 VAC

Body Features

Connector Profile	Low
Primary Product Color	Black



Contact Features

Contact Protection Type	Closed Entry Housing
Mating Square Post Dimension	.64 mm[.025 in]
	10 μ m
Contact Shape & Form	Square
PCB Contact Termination Area Plating Material	Tin-Lead
Contact Base Material	Phosphor Bronze
Contact Mating Area Plating Material	Gold
Contact Mating Area Plating Material Thickness	.762 μ m[30 μ m]
Contact Type	Socket
Contact Current Rating (Max)	3 A

Termination Features

Rectangular Termination Post & Tail Thickness	.2 mm[.008 in]
Rectangular Termination Post & Tail Width	.7 mm[.028 in]
Termination Post & Tail Length	3.3 mm[.13 in]
Termination Method to Printed Circuit Board	Through Hole - Solder

Mechanical Attachment

Mating Alignment	Without
PCB Mount Retention	Without
PCB Mount Alignment	Without
Connector Mounting Type	Board Mount

Housing Features

Mating Entry Location	Bottom & Top
Centerline (Pitch)	2.54 mm[.1 in]
Housing Material	Polyester - GF

Dimensions

Connector Height	5.03 mm[.198 in]
Row-to-Row Spacing	2.54 mm, 3.81 mm[.15 in]
Stack Height	9.02 mm[.355 in]
PCB Thickness (Recommended)	1.57 mm[.055 – .094 in]

Usage Conditions

Housing Temperature Rating	Standard
----------------------------	----------



Operating Temperature Range -65 – 125 °C[-85 – 257 °F]

Operation/Application

Solder Process Feature	Board Standoff
Circuit Application	Signal

Industry Standards

Approved Standards	CSA LR7189, UL E28476
UL Flammability Rating	UL 94V-0

Packaging Features

Packaging Quantity	9
Packaging Type	Box, Tube

Product Compliance

[For compliance documentation, visit the product page on TE.com>](#)

EU RoHS Directive 2011/65/EU	Not Compliant
EU ELV Directive 2000/53/EC	Compliant with Exemptions
China RoHS 2 Directive MIIT Order No 32, 2016	Restricted Materials Above Threshold
EU REACH Regulation (EC) No. 1907/2006	Current ECHA Candidate List: JUNE 2023 (235) Candidate List Declared Against: JUNE 2023 (235) SVHC > Threshold: Pb (13% in Component Part) Article Safe Usage Statements: Do not eat, drink or smoke when using this product. Wash thoroughly after handling. Recycle if possible and dispose of the article by following all applicable governmental regulations relevant to your geographic location.
Halogen Content	Not Low Halogen - contains Br or Cl > 900 ppm.
Solder Process Capability	Wave solder capable to 240°C

Product Compliance Disclaimer

This information is provided based on reasonable inquiry of our suppliers and represents our current actual knowledge based on the information they provided. This information is subject to change. The part numbers that TE has identified as EU RoHS compliant have a maximum concentration of 0.1% by weight in homogenous materials for lead, hexavalent chromium, mercury, PBB, PBDE, DBP, BBP, DEHP, DIBP, and 0.01% for cadmium, or qualify for an exemption to these limits as defined in the Annexes of Directive 2011/65/EU (RoHS2). Finished electrical and electronic equipment products will be CE marked as required by Directive 2011/65/EU. Components may not be CE marked. Additionally, the part numbers that TE has identified as EU ELV compliant have a maximum concentration of 0.1% by weight in homogenous materials for lead, hexavalent chromium, and mercury, and 0.01% for cadmium, or qualify for an exemption to these limits as defined in the Annexes of Directive 2000/53/EC (ELV). Regarding the REACH Regulation, the information TE provides on SVHC in articles for this part number is based on the latest European Chemicals Agency (ECHA) 'Guidance on requirements for substances in articles' posted at this URL: <https://echa.europa.eu/guidance-documents/guidance-on-reach>

Compatible Parts



Also in the Series | Modu Connector System

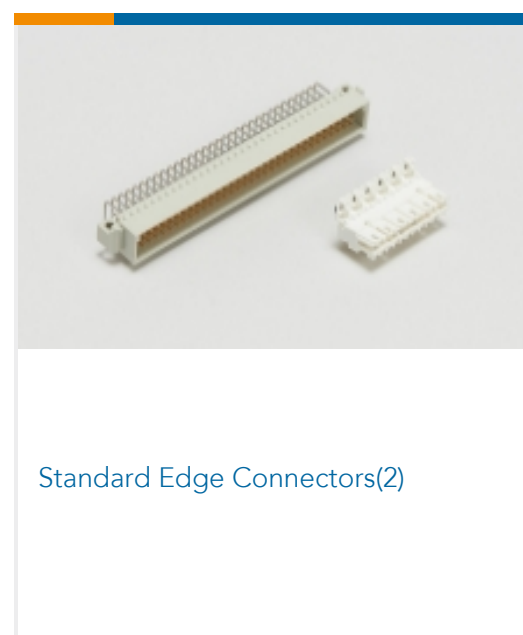
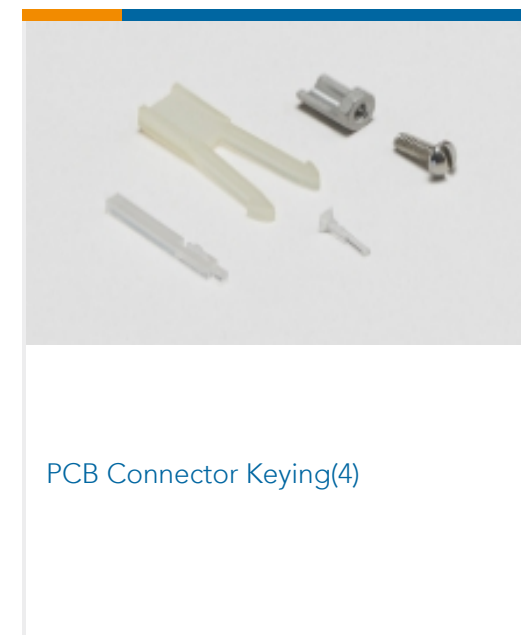
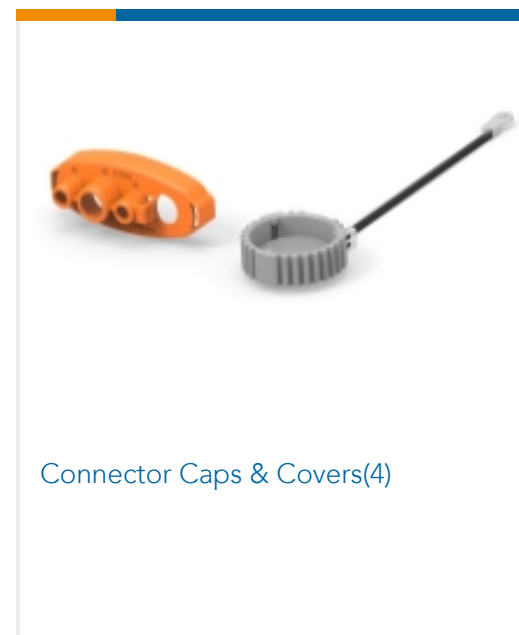
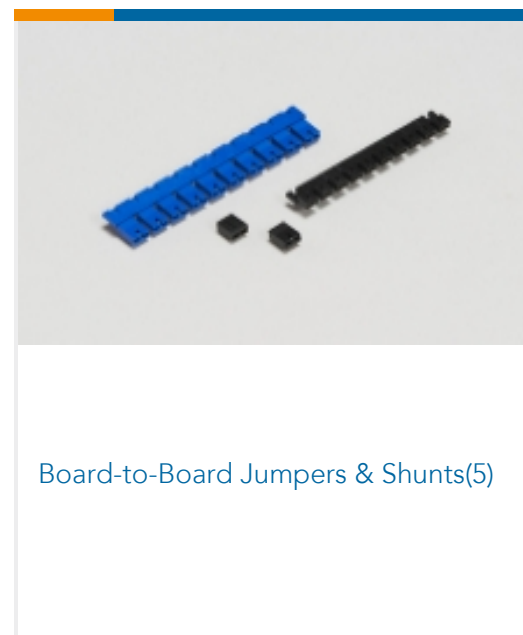
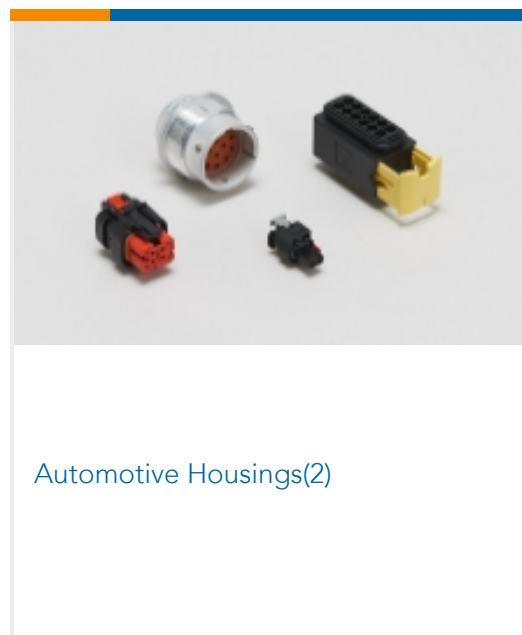

Customers Also Bought

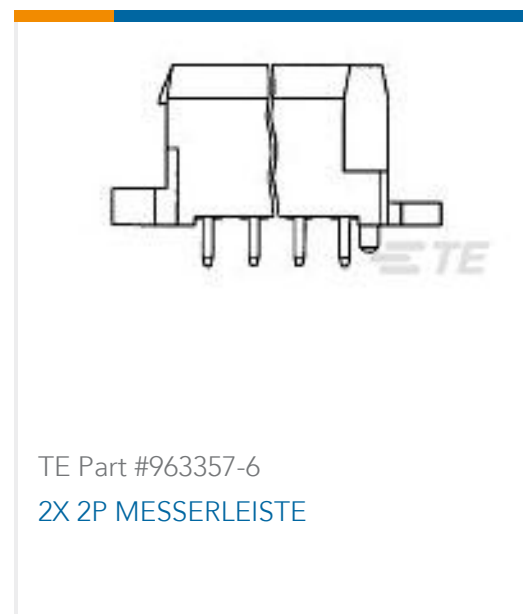

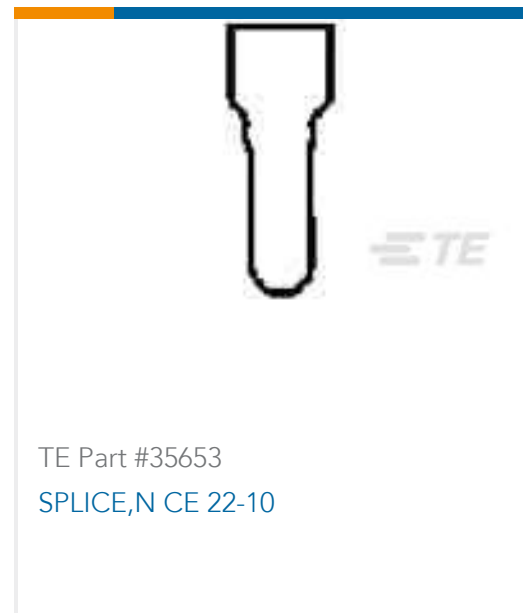

Documents

Product Drawings

[48 MODIV VRT DR CE 100/130](#)

English

CAD Files

[3D PDF](#)

3D

Customer View Model

[ENG_CVM_CVM_2-535542-4_W.2d_dxf.zip](#)

English

Customer View Model

[ENG_CVM_CVM_2-535542-4_W.3d_igs.zip](#)

English

Customer View Model

[ENG_CVM_CVM_2-535542-4_W.3d_stp.zip](#)

English

By downloading the CAD file I accept and agree to the [Terms and Conditions](#) of use.

Product Specifications

[Application Specification](#)

English

Product Environmental Compliance

[Product Compliance](#)

English

[Product Compliance](#)

English