

2-520081-2 ✓ ACTIVE

Ultra-Fast | Ultra-Fast 110

TE Internal #: 2-520081-2

Quick Disconnects, Receptacle, 22 – 18 AWG Wire Size, .32 – .82 mm² Wire Size, Mating Tab Width 3.18 mm / 2.8 mm [.125 in / .11 in], Ultra-Fast 110

[View on TE.com >](#)



Terminals & Splices > Quick Disconnects



Quick Disconnect Terminal Type: **Receptacle**

Wire Size: .32 – .82 mm²

Mating Tab Width: 2.8 mm, 3.18 mm [.11 in, .125 in]

Mating Tab Thickness: .41 mm [.016 in]

Features

Product Type Features

Terminal Features	Wire Stop
Insertion Force	Normal

Configuration Features

Connection Capacity	Single
Compatible With Wire & Cable Type	Discrete Wire

Electrical Characteristics

Voltage Rating	600 V
----------------	-------

Body Features

Insulation Material	Nylon
---------------------	-------

Contact Features

Quick Disconnect Terminal Type	Receptacle
Mating Tab Width	2.8 mm, 3.18 mm [.11 in][.125 in]
Mating Tab Thickness	.41 mm [.016 in]
Terminal Orientation	Straight



Contact Base Material	Brass
Terminal Plating Material	Tin
Crimp Type	F-Crimp
Barrel Type	Closed

Termination Features

Product Terminates To	Wire & Cable
-----------------------	--------------

Mechanical Attachment

Wire Insulation Support	With
Mating Retention Type	Dimple

Dimensions

Terminal Material Thickness	.41 mm[.016 in]
Product Length	18.67 mm[.735 in]
Compatible Insulation Diameter Range	3.05 mm[.12 in]
Wire Size	.32 – .82 mm ²

Usage Conditions

Insulation Option	Fully Insulated
Operating Temperature Range	-40 – 110 °C[-40 – 230 °F]

Industry Standards

Agency/Standard	UL
UL Flammability Rating	UL 94V-2

Packaging Features

Packaging Quantity	1000
Packaging Method	Loose Piece/Carton

Other

Barrel Color	Red
--------------	-----

Product Compliance

[For compliance documentation, visit the product page on TE.com>](#)

EU RoHS Directive 2011/65/EU	Compliant
EU ELV Directive 2000/53/EC	Compliant
China RoHS 2 Directive MIIT Order No 32, 2016	No Restricted Materials Above Threshold
EU REACH Regulation (EC) No. 1907/2006	



Current ECHA Candidate List: JUNE 2023 (235)
 Candidate List Declared Against: JUNE 2023 (235)
 Does not contain REACH SVHC

Halogen Content
 Low Halogen - Br, Cl, F, I < 900 ppm per homogenous material. Also BFR/CFR/PVC Free

Solder Process Capability
 Not applicable for solder process capability

Product Compliance Disclaimer

This information is provided based on reasonable inquiry of our suppliers and represents our current actual knowledge based on the information they provided. This information is subject to change. The part numbers that TE has identified as EU RoHS compliant have a maximum concentration of 0.1% by weight in homogenous materials for lead, hexavalent chromium, mercury, PBB, PBDE, DBP, BBP, DEHP, DIBP, and 0.01% for cadmium, or qualify for an exemption to these limits as defined in the Annexes of Directive 2011/65/EU (RoHS2). Finished electrical and electronic equipment products will be CE marked as required by Directive 2011/65/EU. Components may not be CE marked. Additionally, the part numbers that TE has identified as EU ELV compliant have a maximum concentration of 0.1% by weight in homogenous materials for lead, hexavalent chromium, and mercury, and 0.01% for cadmium, or qualify for an exemption to these limits as defined in the Annexes of Directive 2000/53/EC (ELV). Regarding the REACH Regulation, the information TE provides on SVHC in articles for this part number is based on the latest European Chemicals Agency (ECHA) 'Guidance on requirements for substances in articles' posted at this URL: <https://echa.europa.eu/guidance-documents/guidance-on-reach>

Compatible Parts

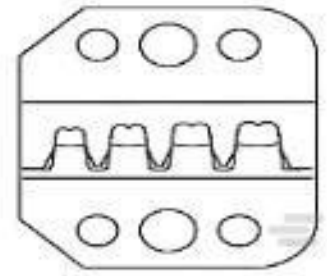

TE Part # 58628-2
 PROCIMP DIESET 26-14 ULTRAFAST



TE Part # 90390-3
 DIES ULTRA-FAST FASTON 22-18 DIE SET



TE Part # 58628-1
 PROCIMP T&D 26-14 ULTRAFAST



TE Part # 2217481-1
 KIT, BTLI, SDE CLOSED HEAD



TE Part # 2217481-2
 KIT, BTLI, SDE CLOSED HEAD

Also in the Series | **Ultra-Fast 110**



Quick Disconnects(14)

Customers Also Bought

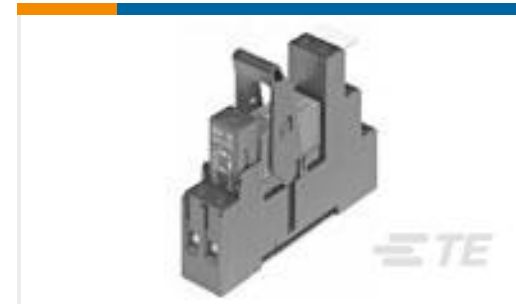
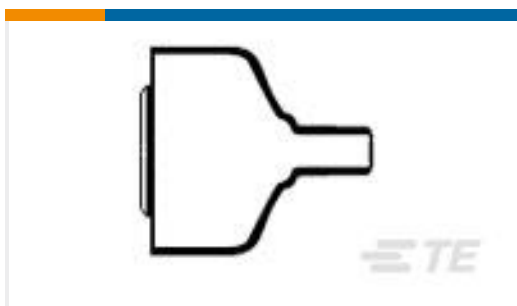
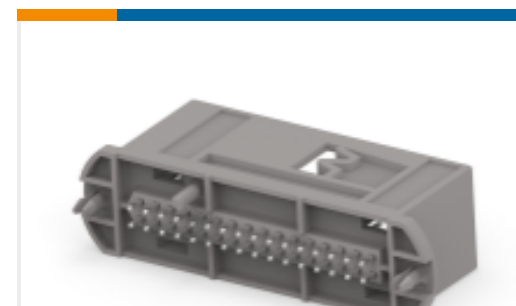
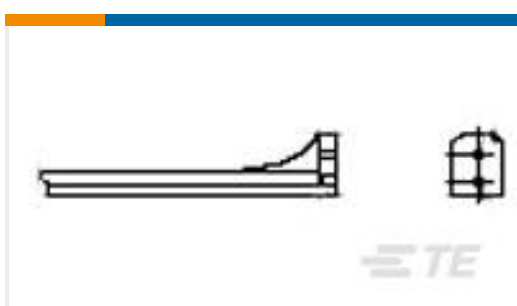
TE Part #6609052-2
10VN1=F7416 S0TE Part #5745783-5
25 MSFL RCPT RA 318 (SL,FM)TE Part #5787190-5
50 50SR R/A RCPT ASSY,RDSN L/FTE Part #6-1415073-1
RT3S4T30TE Part #814415-000
214A032-3-0TE Part #1437596-3
TRD21N10WL=DPDT ROCKER BLACKTE Part #2-1423675-0
W57-XB2A99C10-5=CKTBKR,THERM,PTE Part #8-966658-3
32pos MQS .63 header 180degTE Part #583671-1
CARD GUIDE

Documents

Product Drawings

[ULTRAFast 110 ASSY REC 22-18 TPBR LP](#)

English

CAD Files

[3D PDF](#)

[3D](#)

[Customer View Model](#)

[ENG_CVM_CVM_2-520081-2_C.2d_dxf.zip](#)



English

Customer View Model

[ENG_CVM_CVM_2-520081-2_C.3d_igs.zip](#)

English

Customer View Model

[ENG_CVM_CVM_2-520081-2_C.3d_stp.zip](#)

English

By downloading the CAD file I accept and agree to the [Terms and Conditions](#) of use.

Datasheets & Catalog Pages

[Ultra-Fast and Ultra Fast Plus](#)

English

Product Specifications

[Application Specification](#)

English

Product Environmental Compliance

[Product Compliance Document](#)

English

[Product Compliance Document](#)

English

Agency Approvals

[Agency Approval Document](#)

English