

2-34149-3 ✓ ACTIVE

PLASTI-GRIP

TE Internal #: 2-34149-3

Closed Ring Tongue Terminal, 22 – 16 AWG, #10 Stud Size, 4.82 mm [.19 in] Stud Diameter, Closed Barrel, Straight, Tin, PLASTI-GRIP

[View on TE.com >](#)



Terminals & Splices > Ring Terminals

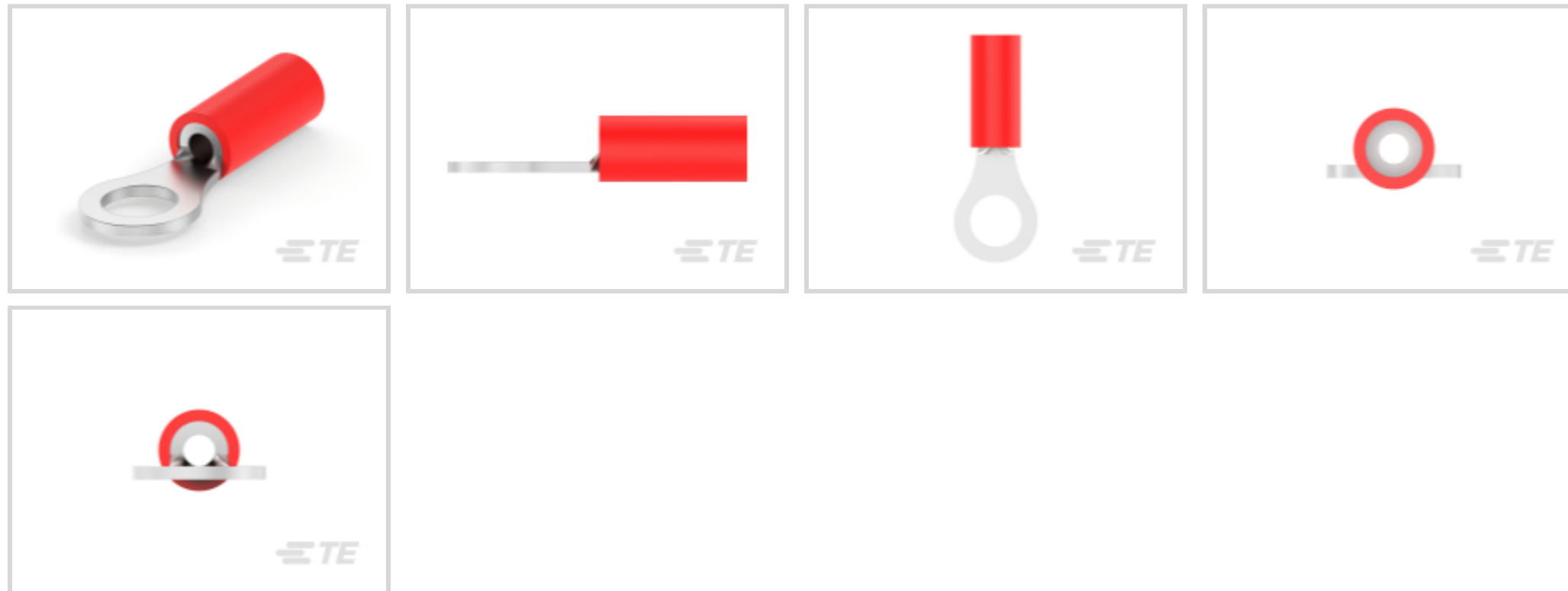

Ring Terminal Product Type: Closed Ring Tongue Terminal

Wire Size: 509 – 3260 CMA

Stud Size: #10

### Features

#### Product Type Features

Ring Terminal Product Type	Closed Ring Tongue Terminal
Stud Size	#10
Sealable	No
Wire Insulation Support Retention Type	Insulation Support

#### Configuration Features

Number of Holes	1
-----------------	---

#### Electrical Characteristics

Voltage Rating	600 V
----------------	-------

#### Body Features

Product Weight	.722 g
----------------	--------

#### Contact Features

Barrel Type	Closed
Terminal Orientation	Straight
Terminal Plating Material	Tin

#### Mechanical Attachment

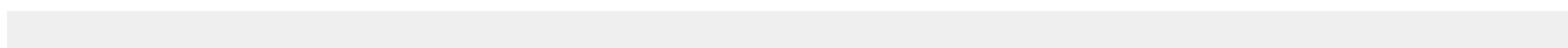



Wire Insulation Support	With
-------------------------	------

### Dimensions

Wire Size	509 – 3260 CMA
Stud Diameter	4.82 mm [.19 in]
Tongue Thickness	.79 mm [.031 in]
Product Length	22.99 mm [.91 in]
Compatible Insulation Diameter (Max)	5.08 mm [.2 in]
Compatible Insulation Diameter Range	2.67 – 5.08 mm [.105 – .2 in]

### Usage Conditions

Insulation Option	Partially Insulated
Operating Temperature Range	105 °C [221 °F]

### Operation/Application

Compatible With Wire Base Material	Copper
Compatible With Wire Plating Material	Tin

### Industry Standards

Government Qualified Terminal	No
-------------------------------	----

### Packaging Features

Packaging Quantity	5000
Packaging Method	Tape Mounted

### Product Compliance

[For compliance documentation, visit the product page on TE.com>](#)

EU RoHS Directive 2011/65/EU	Compliant
EU ELV Directive 2000/53/EC	Compliant
China RoHS 2 Directive MIIT Order No 32, 2016	No Restricted Materials Above Threshold
EU REACH Regulation (EC) No. 1907/2006	Current ECHA Candidate List: JUNE 2023 (235) Candidate List Declared Against: JUNE 2023 (235) Does not contain REACH SVHC
Halogen Content	Not Low Halogen - contains Br or Cl > 900 ppm.
Solder Process Capability	Not applicable for solder process capability

Product Compliance Disclaimer

This information is provided based on reasonable inquiry of our suppliers and represents our current actual knowledge based on the information they provided. This information is subject to change. The part numbers that TE has identified as EU RoHS compliant have a maximum concentration of 0.1% by weight in homogenous materials for lead, hexavalent chromium, mercury, PBB, PBDE, DBP, BBP, DEHP, DIBP, and 0.01% for cadmium, or qualify for an exemption to these limits as defined in the Annexes of Directive 2011/65/EU (RoHS2). Finished electrical and electronic equipment products will be CE marked as required by Directive 2011/65/EU. Components may not be CE marked. Additionally, the part numbers that TE has identified as EU ELV compliant have a maximum concentration of 0.1% by weight in homogenous materials for lead, hexavalent chromium, and mercury, and 0.01% for cadmium, or qualify for an exemption to these limits as defined in the Annexes of Directive 2000/53/EC (ELV). Regarding the REACH Regulation, the information TE provides on SVHC in articles for this part number is based on the latest European Chemicals Agency (ECHA) 'Guidance on requirements for substances in articles' posted at this URL: <https://echa.europa.eu/guidance-documents/guidance-on-reach>

## Compatible Parts



REPRESENTATION ONLY

TE Part # 47386  
DAHT PG PIDG 26-16 ASSY



TE Part # 58423-1  
DIE, RBY IS9252



TE Part # 58433-3  
PRO CR ASSY, RBY IS9252



TE Part # 1SET191001R0000  
CRIMP-HT



TE Part # 169404  
CERTI-LOK DIE

## Also in the Series | PLASTI-GRIP



Compression Connectors(3)



Crimp Wire Pins, Tabs & Ferrules(25)



Ring Terminals(333)

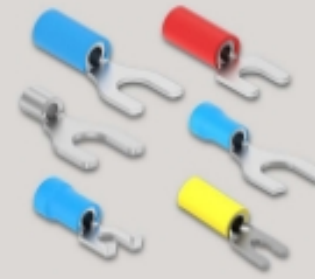

Spade Terminals(195)



Splices(50)

### Customers Also Bought



TE Part #640907-1  
RECEPT,PIDG FASTON 12-10 250

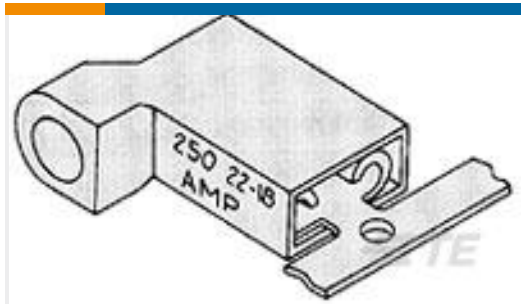

TE Part #3-520133-2  
ULTRA-FAST 250 ASY REC 16-14 AWG TPBR



TE Part #2-520264-2  
ULTRAFast 250 ASSY REC 22-18 TPBR LP

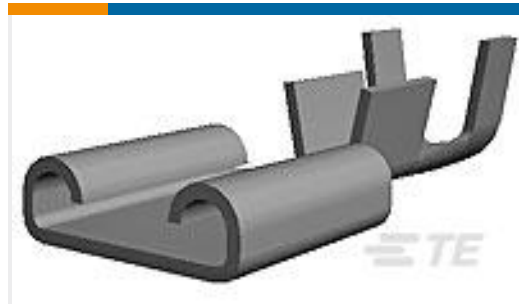

TE Part #41774  
250 FASTON REC 18-14 AWG TPBZ

### Documents

#### Product Drawings

[PG R 22-16 COMM 22-18 MIL 10](#)

English

#### CAD Files

Customer View Model

[ENG\\_CVM\\_CVM\\_2-34149-3\\_S.2d\\_dxf.zip](#)

English

3D PDF

3D

Customer View Model

[ENG\\_CVM\\_CVM\\_2-34149-3\\_S.3d\\_igs.zip](#)

English

Customer View Model

[ENG\\_CVM\\_CVM\\_2-34149-3\\_S.3d\\_stp.zip](#)

English

By downloading the CAD file I accept and agree to the [Terms and Conditions](#) of use.

#### Product Specifications

[Application Specification](#)

English

#### Product Environmental Compliance

[Product Compliance](#)

English

[Product Compliance](#)



English

---

**Instruction Sheets**

**Instruction Sheet (U.S.)**

English

**LARGE EXPANSION PRODUCTS (FOR WIRE INSTULATION WITH 1/16" AND 5/64" WA**

English

---

**Agency Approvals**

**UL Report**

English