



PIDG

TE Internal #: 2-327958-1

Rectangular Tongue Terminal, 16 – 14 AWG, M3.5 / #6 Stud Size, 3.73 mm [.147 in] Stud Diameter, Closed Barrel, Straight, Tin, PIDG

[View on TE.com >](#)

Terminals & Splices > Spade Terminals > PIDG Rectangular Tongue Terminals

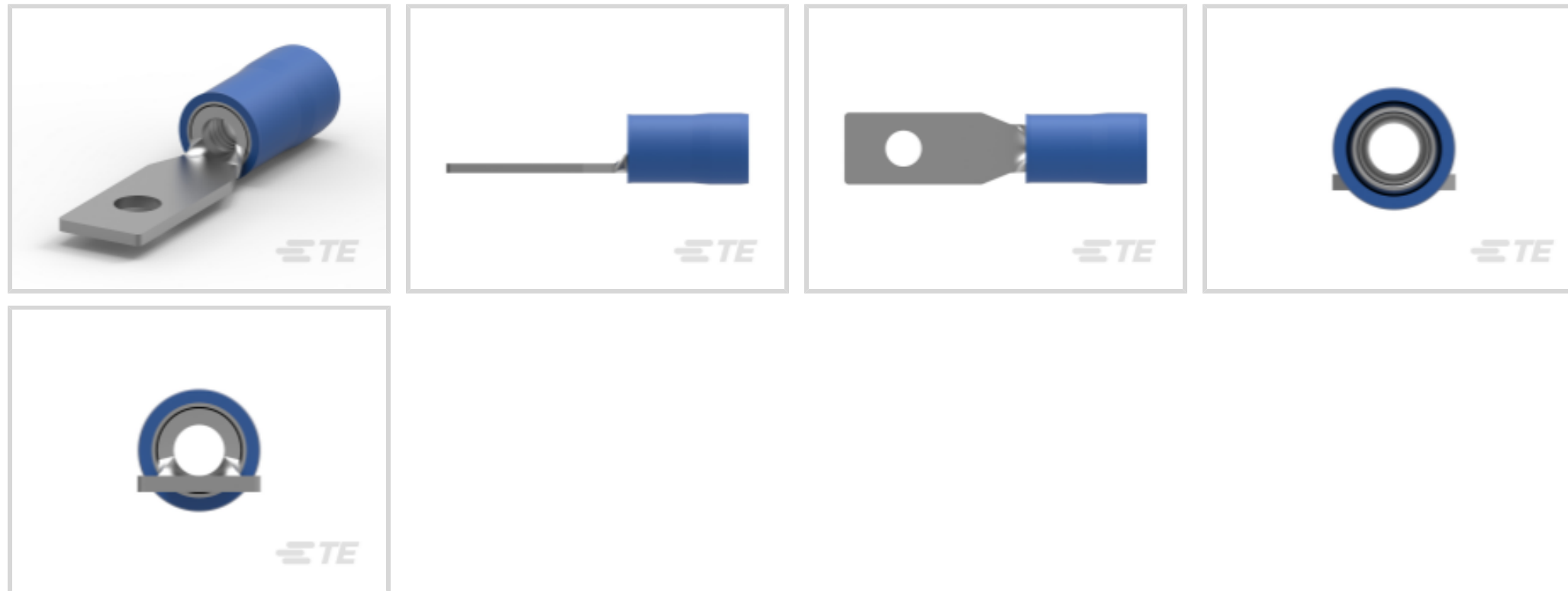

Spade Terminal Type: **Rectangular Tongue Terminal**

Wire Size: **2050 – 5180 CMA**

Stud Size: **#6, M3.5**

[All PIDG Rectangular Tongue Terminals \(30\)](#)

Features

Product Type Features

Stud Size	#6, M3.5
Sealable	No
Wire Insulation Support Retention Type	Insulation Support

Configuration Features

Number of Holes	1
-----------------	---

Electrical Characteristics

Voltage Rating	300 V
----------------	-------

Body Features

Product Weight	1.164 g
----------------	---------

Contact Features

Spade Terminal Type	Rectangular Tongue Terminal
Barrel Type	Closed
Terminal Orientation	Straight
Terminal Plating Material	Tin



Mechanical Attachment

Wire Insulation Support	With
-------------------------	------

Dimensions

Wire Size	2050 – 5180 CMA
Stud Diameter	3.73 mm [.147 in]
Tongue Thickness	.79 mm [.031 in]
Product Length	25.81 mm [1.016 in]
Compatible Insulation Diameter (Max)	4.32 mm [.17 in]
Compatible Insulation Diameter Range	2.92 – 4.31 mm [.115 – .17 in]

Usage Conditions

Insulation Option	Partially Insulated
Operating Temperature Range	105 °C [221 °F]

Operation/Application

Compatible With Wire Base Material	Copper
Compatible With Wire Plating Material	Tin

Industry Standards

Government Qualified Terminal	No
-------------------------------	----

Packaging Features

Packaging Quantity	1000
Packaging Method	Loose Piece

Product Compliance

[For compliance documentation, visit the product page on TE.com>](#)

EU RoHS Directive 2011/65/EU	Compliant
EU ELV Directive 2000/53/EC	Compliant
China RoHS 2 Directive MIIT Order No 32, 2016	No Restricted Materials Above Threshold
EU REACH Regulation (EC) No. 1907/2006	Current ECHA Candidate List: JUNE 2023 (235) Candidate List Declared Against: JUNE 2023 (235) Does not contain REACH SVHC
Halogen Content	Low Halogen - Br, Cl, F, I < 900 ppm per homogenous material. Also BFR/CFR/PVC Free

Solder Process Capability

Not applicable for solder process capability

Product Compliance Disclaimer

This information is provided based on reasonable inquiry of our suppliers and represents our current actual knowledge based on the information they provided. This information is subject to change. The part numbers that TE has identified as EU RoHS compliant have a maximum concentration of 0.1% by weight in homogenous materials for lead, hexavalent chromium, mercury, PBB, PBDE, DBP, BBP, DEHP, DIBP, and 0.01% for cadmium, or qualify for an exemption to these limits as defined in the Annexes of Directive 2011/65/EU (RoHS2). Finished electrical and electronic equipment products will be CE marked as required by Directive 2011/65/EU. Components may not be CE marked. Additionally, the part numbers that TE has identified as EU ELV compliant have a maximum concentration of 0.1% by weight in homogenous materials for lead, hexavalent chromium, and mercury, and 0.01% for cadmium, or qualify for an exemption to these limits as defined in the Annexes of Directive 2000/53/EC (ELV). Regarding the REACH Regulation, the information TE provides on SVHC in articles for this part number is based on the latest European Chemicals Agency (ECHA) 'Guidance on requirements for substances in articles' posted at this URL: <https://echa.europa.eu/guidance-documents/guidance-on-reach>

Compatible Parts



TE Part # 59824-1
TETRA-CRIMP PIDG PG FASTON 22-10 ASSY



TE Part # 59250
T-HEAD PIDG 26-14 ASSY



TE Part # 47387
DAHT PG PIDG 20-14 ASSY



TE Part # 58423-1
DIE, RBY IS9252



TE Part # 47387-7
DAHT PG PIDG 16-12 ASSY



TE Part # 58433-3
PRO CR ASSY, RBY IS9252



TE Part # 525691
DAHT PG PIDG 16-14 ASSY



TE Part # 539691-2
ERGO DIE R.B.Y

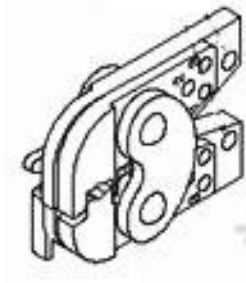

TE Part # 1-47387-0
DAHT PIDG PG 16-14 HEAD



TE Part # 2063030-1
SDE DIESET, RBY, UL



TE Part # 47807-1
DIES PIDG 16-14 DIE SET



TE Part # 169400
CERTI-LOK FRAME W/O DIES

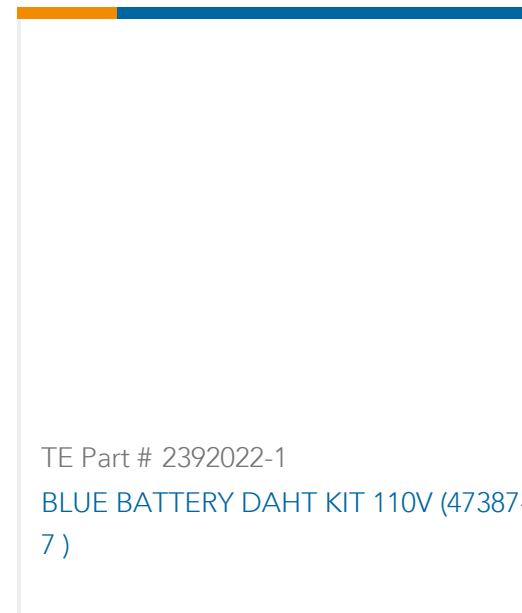
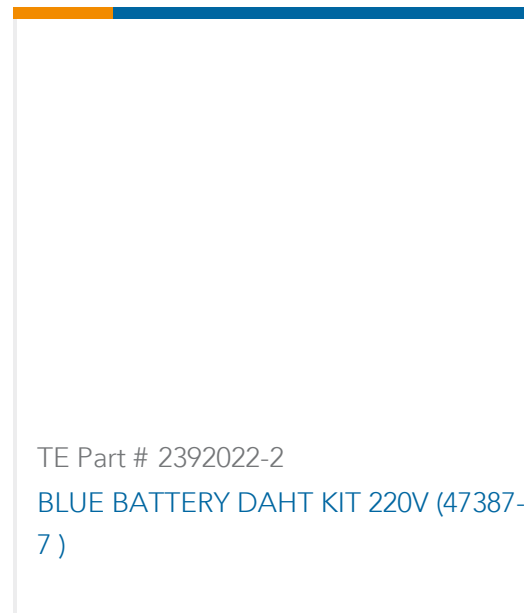

Also in the Series | PIDG

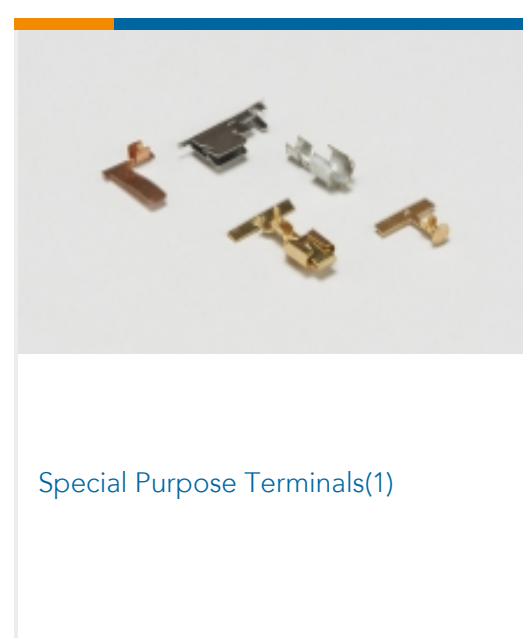
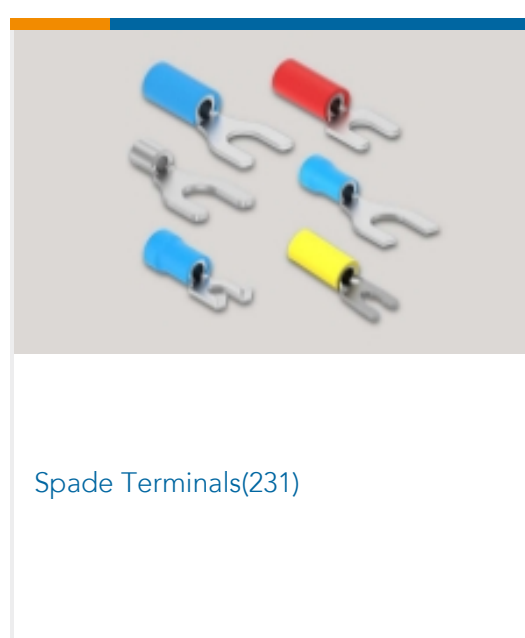
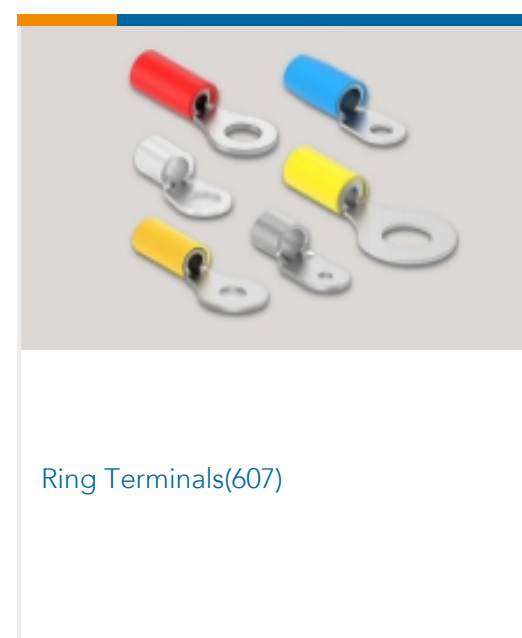
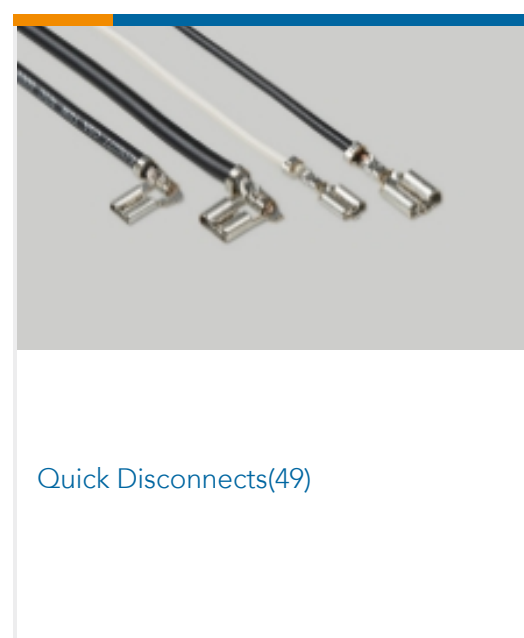
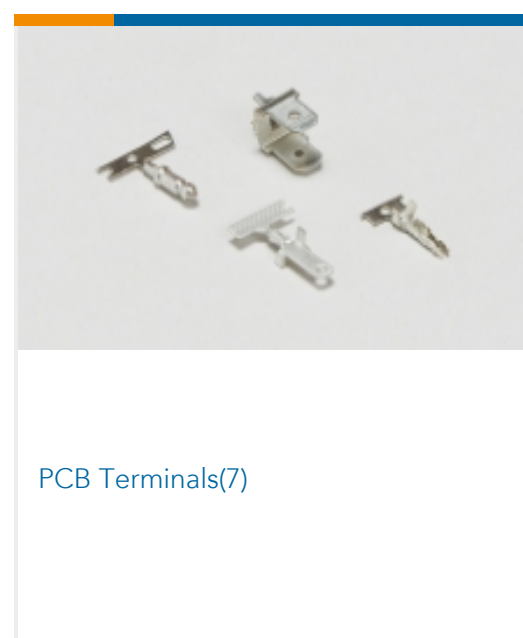
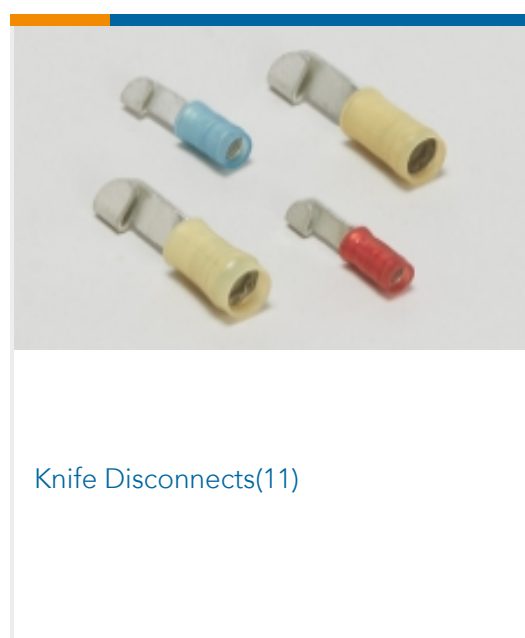
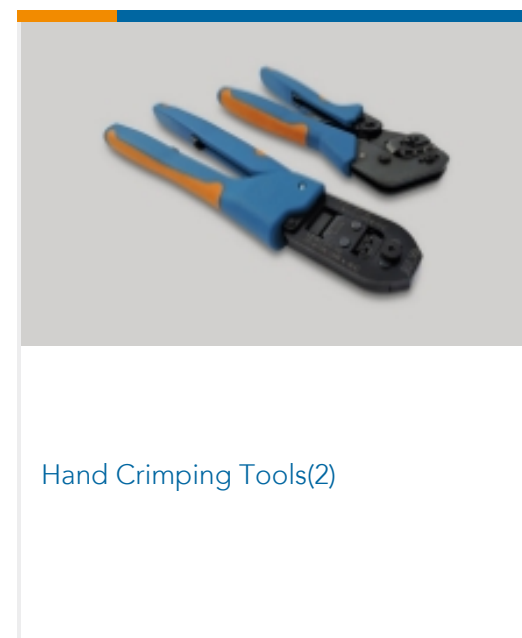
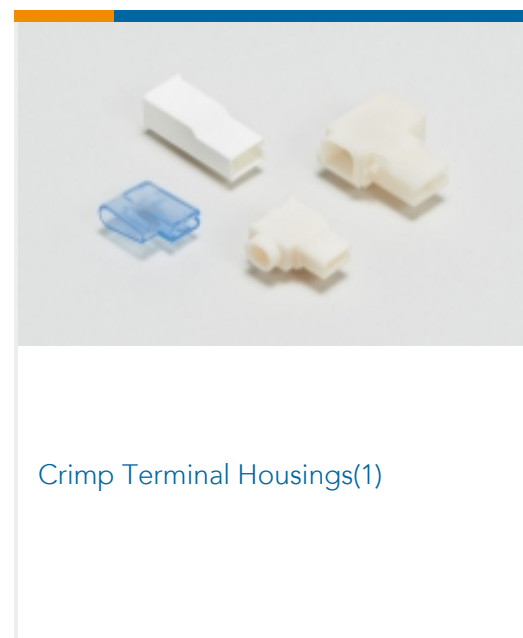
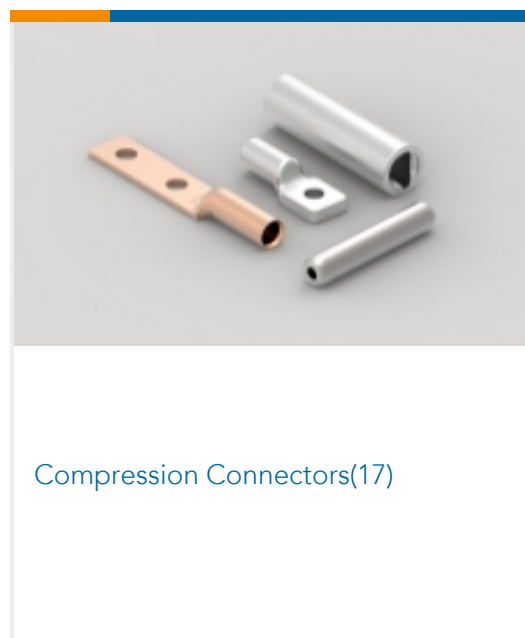

Customers Also Bought



TE Part #320565
TERMINAL,PIDG R 16-14 8



TE Part #1217558-2
250 FASTON,TAB,TPBR

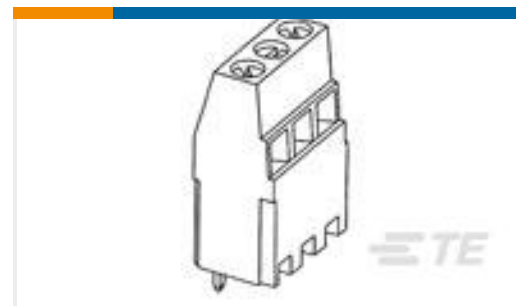

TE Part #1-282901-2
TERM-BLK PCB MT 2ND 12P.5.08,



TE Part #2-327960-1
TERMINAL,PIDG RECT 12-10 6



TE Part #2-284047-9
Vertical Plug, RH, 5.08mm, Gn,



TE Part #3-284047-0
Vertical Plug, RH, 5.08mm, Gn,

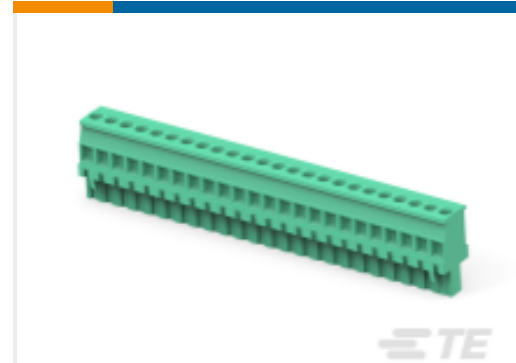

TE Part #3-284047-1
Vertical Plug, RH, 5.08mm, Gn,



TE Part #3-284047-5
Vertical Plug, RH, 5.08mm, Gn,

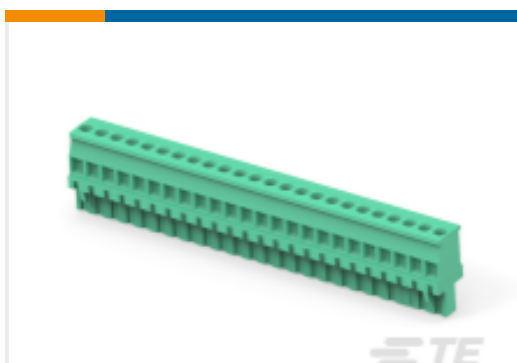

TE Part #3-284047-7
Vertical Plug, RH, 5.08mm, Gn,

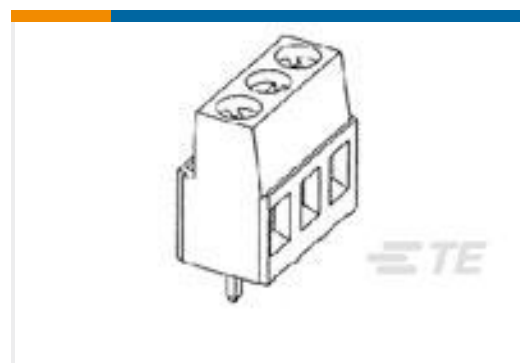

TE Part #796911-3
3 POS TERMI-BLOK PCB SD WR ENT

Documents

Product Drawings

[TERMINAL,PIDG RECT 16-14 6](#)

English

CAD Files

[3D PDF](#)

English

Customer View Model

[ENG_CVM_2-327958-1_P.3d_igs.zip](#)

English

Customer View Model

[ENG_CVM_2-327958-1_P.3d_stp.zip](#)

English

Customer View Model

[ENG_CVM_2-327958-1_P.2d_dxf.zip](#)

English

By downloading the CAD file I accept and agree to the [Terms and Conditions](#) of use.

Product Specifications



Application Specification

English

Product Environmental Compliance

Product Compliance

English

Product Compliance

English

Instruction Sheets

Instruction Sheet (U.S.)

English

AMP PIDG Terminals for Bu-Ship Terminal Blocks

English

Agency Approvals

UL Report

English