



PIDG

TE Internal #: 2-32562-1

Spade Flange Tongue Terminal, 22 AWG, M3.5 / #6 Stud Size, 3.68 mm [.145 in] Stud Diameter, Closed Barrel, Flanged, Tin, Partially Insulated, PIDG

[View on TE.com >](#)

Terminals & Splices > Spade Terminals > PIDG Flanged Spade Tongue Terminals

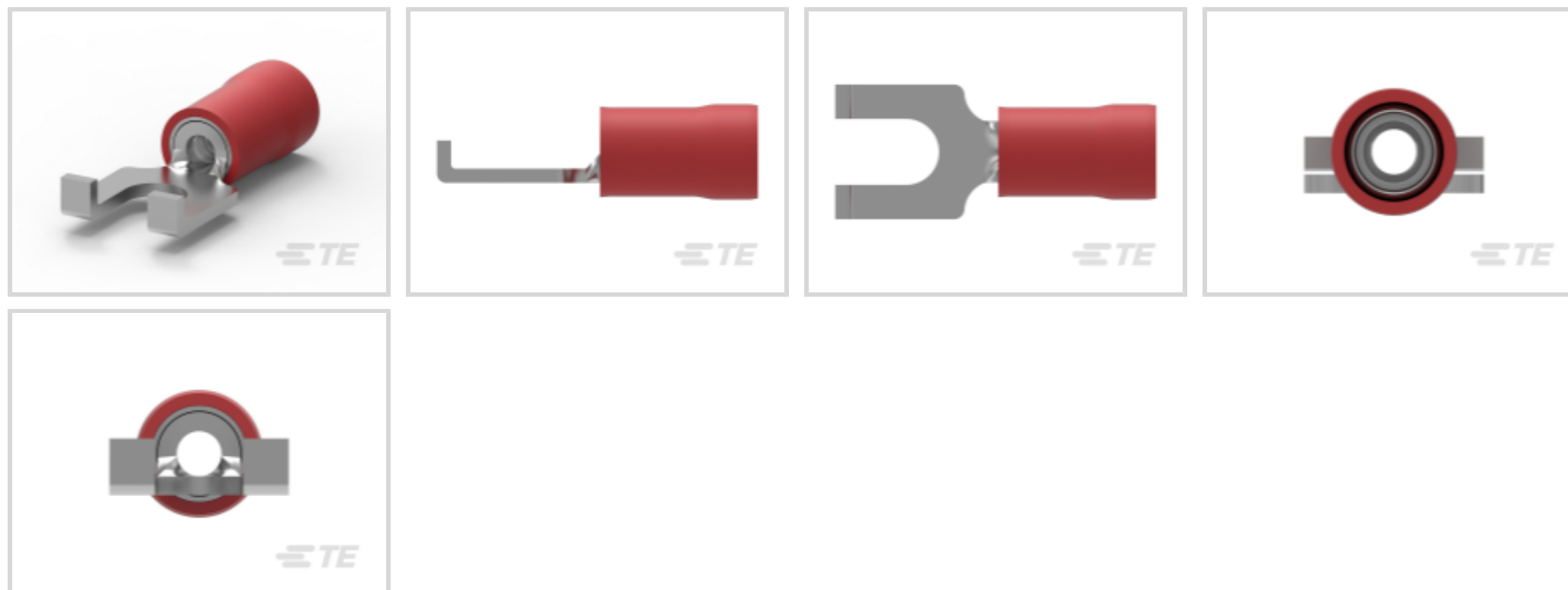

Spade Terminal Type: **Spade Flange Tongue Terminal**

Wire Size: **509 – 3260 CMA**

Stud Size: **#6, M3.5**

[All PIDG Flanged Spade Tongue Terminals \(51\)](#)

Features

Product Type Features

Stud Size	#6, M3.5
Sealable	No
Wire Insulation Support Retention Type	Insulation Support

Electrical Characteristics

Voltage Rating	300 V
----------------	-------

Body Features

Product Weight	.839 g
Insulation Sleeve Color	Red
Stripe Color	Red

Contact Features

Spade Terminal Type	Spade Flange Tongue Terminal
Barrel Type	Closed
Terminal Orientation	Flanged
Terminal Plating Material	Tin



Mechanical Attachment

Wire Insulation Support	With
-------------------------	------

Dimensions

Wire Size	509 – 3260 CMA
Stud Diameter	3.68 mm [.145 in]
Tongue Thickness	.79 mm [.031 in]
Product Length	18.72 mm [.737 in]
Compatible Insulation Diameter (Max)	3.56 mm [.14 in]
Compatible Insulation Diameter Range	2.67 – 3.56 mm [.105 – .14 in]

Usage Conditions

Insulation Option	Partially Insulated
Operating Temperature Range	105 °C [221 °F]

Operation/Application

Compatible With Wire Base Material	Copper
Compatible With Wire Plating Material	Tin

Industry Standards

Government Qualified Terminal	No
-------------------------------	----

Packaging Features

Packaging Quantity	5000
Packaging Method	Tape Mounted

Product Compliance

[For compliance documentation, visit the product page on TE.com>](#)

EU RoHS Directive 2011/65/EU	Compliant
EU ELV Directive 2000/53/EC	Compliant
China RoHS 2 Directive MIIT Order No 32, 2016	No Restricted Materials Above Threshold
EU REACH Regulation (EC) No. 1907/2006	Current ECHA Candidate List: JUNE 2023 (235) Candidate List Declared Against: JUNE 2023 (235) Does not contain REACH SVHC
Halogen Content	Low Halogen - Br, Cl, F, I < 900 ppm per homogenous material. Also BFR/CFR/PVC Free

Solder Process Capability

Not applicable for solder process capability

Product Compliance Disclaimer

This information is provided based on reasonable inquiry of our suppliers and represents our current actual knowledge based on the information they provided. This information is subject to change. The part numbers that TE has identified as EU RoHS compliant have a maximum concentration of 0.1% by weight in homogenous materials for lead, hexavalent chromium, mercury, PBB, PBDE, DBP, BBP, DEHP, DIBP, and 0.01% for cadmium, or qualify for an exemption to these limits as defined in the Annexes of Directive 2011/65/EU (RoHS2). Finished electrical and electronic equipment products will be CE marked as required by Directive 2011/65/EU. Components may not be CE marked. Additionally, the part numbers that TE has identified as EU ELV compliant have a maximum concentration of 0.1% by weight in homogenous materials for lead, hexavalent chromium, and mercury, and 0.01% for cadmium, or qualify for an exemption to these limits as defined in the Annexes of Directive 2000/53/EC (ELV). Regarding the REACH Regulation, the information TE provides on SVHC in articles for this part number is based on the latest European Chemicals Agency (ECHA) 'Guidance on requirements for substances in articles' posted at this URL: <https://echa.europa.eu/guidance-documents/guidance-on-reach>

Compatible Parts



REPRESENTATION ONLY

TE Part # 47386
DAHT PG PIDG 26-16 ASSY



TE Part # 58423-1
DIE, RBY IS9252



TE Part # 58433-3
PRO CR ASSY, RBY IS9252



TE Part # 1SET191001R0000
CRIMP-HT



TE Part # 169404
CERTI-LOK DIE

Also in the Series | PIDG

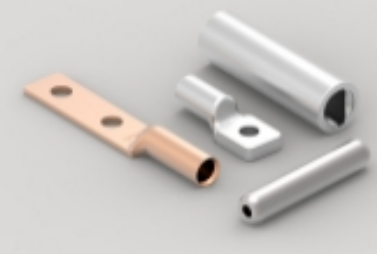

Compression Connectors(17)

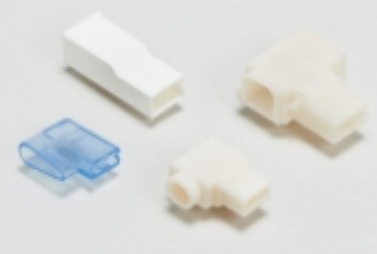

Crimp Terminal Housings(1)



Crimp Wire Pins, Tabs & Ferrules(41)



Hand Crimping Tools(2)



Knife Disconnects(11)



PCB Terminals(7)



Quick Disconnects(49)



Ring Terminals(607)

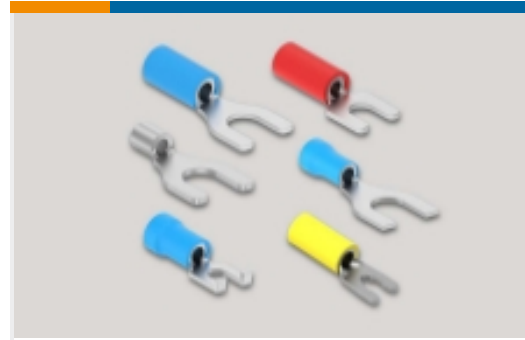

Spade Terminals(231)



Special Purpose Terminals(1)



Splices(45)

Customers Also Bought

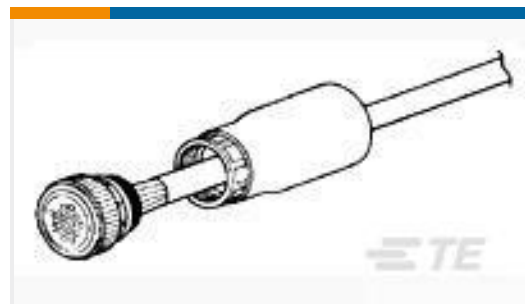

TE Part #54012-1
CPC STRAIN RELIEF,SIZE 23



TE Part #4-881545-2
AMP SHUNT ASS'Y

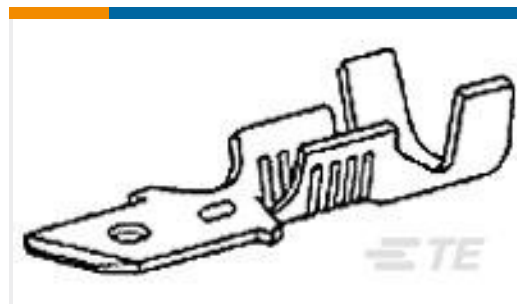

TE Part #60850-2
187 FASTON REC 18-14 AWG TPBR

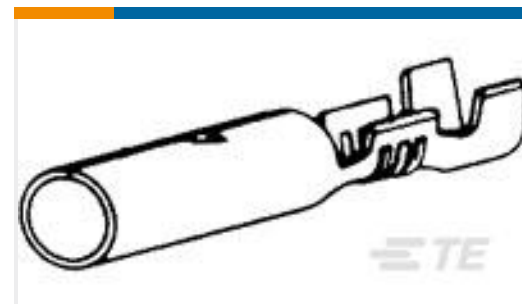

TE Part #61412-1
SHUR PLUG 180 RECEPTACLE 18-14 AWG BR



TE Part #1217070-1
SHUR PLUG 180 RECEPTACLE 12-8 AWG TPBR



TE Part #292331-3
BATTERY 3P SMT 1.6MM PITCH ASSEMBLY CONN



TE Part #1-2201855-2
MINI I/O PLUG KIT TYPE II M

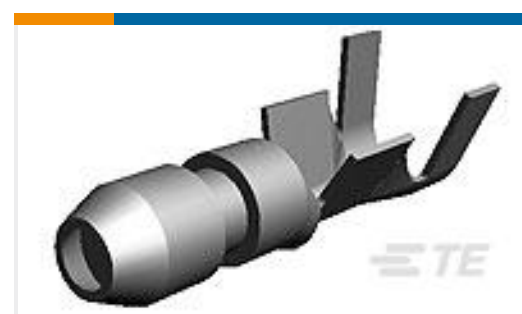

TE Part #170002-5
SHUR PLUG 20-14 AWG 0.5 X 11.44 TPBR



TE Part #1-2213772-3
AV22 SPM 5A MOVE RING LED GREEN 12V

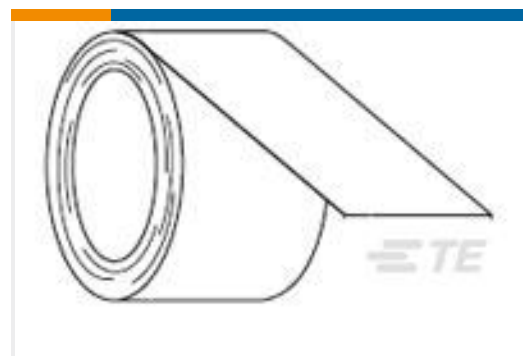

TE Part #735200-000
TTP200CL-10

Documents



Product Drawings

[PIDG SPDFLG 22-16COMM22-18MIL6](#)

English

CAD Files

Customer View Model

[ENG_CVM_CVM_2-32562-1_S.3d_stp.zip](#)

English

Customer View Model

[ENG_CVM_CVM_2-32562-1_S.2d_dxf.zip](#)

English

[3D PDF](#)

3D

Customer View Model

[ENG_CVM_CVM_2-32562-1_S.3d_igs.zip](#)

English

By downloading the CAD file I accept and agree to the [Terms and Conditions](#) of use.

Product Specifications

[Application Specification](#)

English

Product Environmental Compliance

[MD_2-32562-1_050420181147_dmtec](#)

English

[MD_2-32562-1_050420181147_dmtec](#)

English

Agency Approvals

[UL Report](#)

English

[UL Report](#)

English