



PIDG

TE Internal #: 2-31880-1

Closed Ring Tongue Terminal, 22 AWG, #4 / M2.5 Stud Size, 3.02 mm [.119 in] Stud Diameter, Closed Barrel, Straight, Tin, Partially Insulated

[View on TE.com >](#)

Terminals & Splices > Ring Terminals > PIDG Ring Tongue Terminals

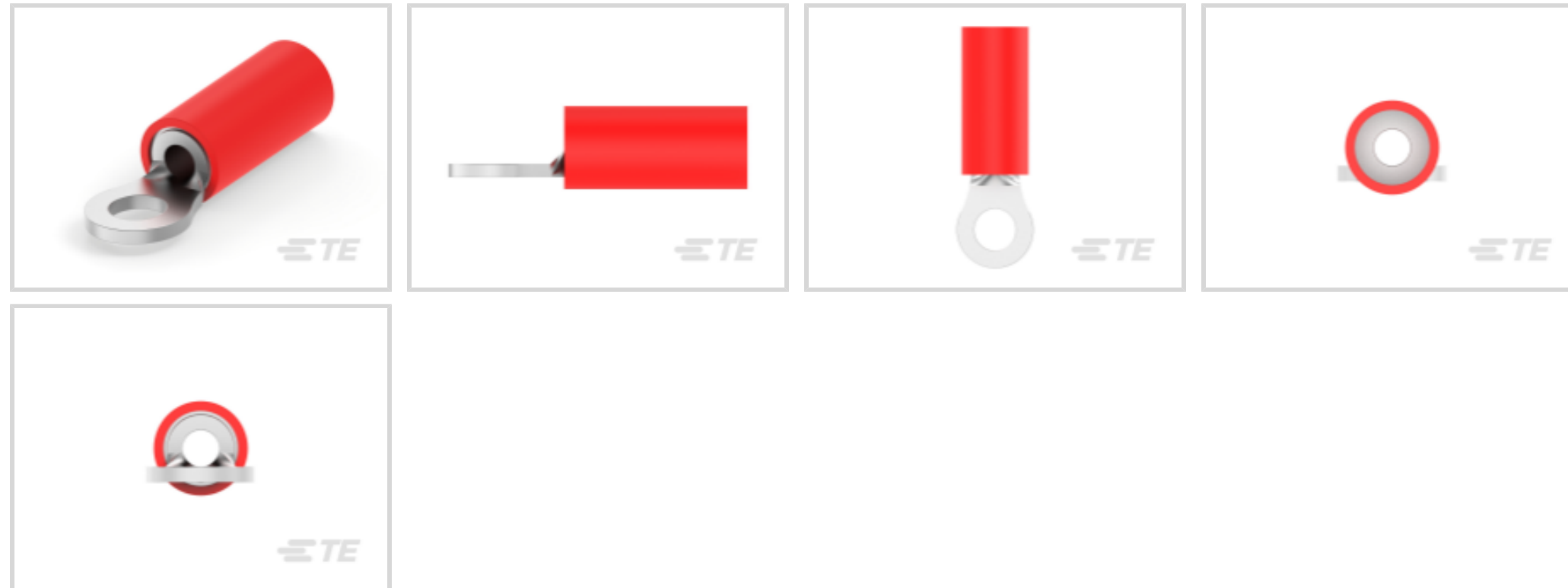

Ring Terminal Product Type: Closed Ring Tongue Terminal

Wire Size: 509 – 3260 CMA

Stud Size: #4, M2.5

[All PIDG Ring Tongue Terminals \(418\)](#)

Features

Product Type Features

Ring Terminal Product Type	Closed Ring Tongue Terminal
Stud Size	#4, M2.5
Sealable	No
Wire Insulation Support Retention Type	Insulation Support

Configuration Features

Number of Holes	1
-----------------	---

Electrical Characteristics

Voltage Rating	300 V
----------------	-------

Body Features

Product Weight	.705 g
Insulation Sleeve Color	Red
Stripe Color	Red

Contact Features

--	--



Barrel Type	Closed
Terminal Orientation	Straight
Terminal Plating Material	Tin

Mechanical Attachment

Wire Insulation Support	With
-------------------------	------

Dimensions

Wire Size	509 – 3260 CMA
Stud Diameter	3.02 mm [.119 in]
Tongue Thickness	.79 mm [.031 in]
Product Length	17.07 mm [.672 in]
Compatible Insulation Diameter (Max)	3.56 mm [.14 in]
Compatible Insulation Diameter Range	2.67 – 3.56 mm [.105 – .14 in]

Usage Conditions

Insulation Option	Partially Insulated
Operating Temperature Range	105 °C [221 °F]

Operation/Application

Compatible With Wire Base Material	Copper
Compatible With Wire Plating Material	Tin

Industry Standards

Government Qualified Terminal	No
-------------------------------	----

Packaging Features

Packaging Quantity	5000
Packaging Method	Tape Mounted

Product Compliance

[For compliance documentation, visit the product page on TE.com>](#)

EU RoHS Directive 2011/65/EU	Compliant
EU ELV Directive 2000/53/EC	Compliant
China RoHS 2 Directive MIIT Order No 32, 2016	No Restricted Materials Above Threshold
EU REACH Regulation (EC) No. 1907/2006	Current ECHA Candidate List: JUNE 2023 (235) Candidate List Declared Against: JUNE 2023 (235)



Does not contain REACH SVHC

Halogen Content

Low Halogen - Br, Cl, F, I < 900 ppm per homogenous material. Also BFR/CFR/PVC Free

Solder Process Capability

Not applicable for solder process capability

Product Compliance Disclaimer

This information is provided based on reasonable inquiry of our suppliers and represents our current actual knowledge based on the information they provided. This information is subject to change. The part numbers that TE has identified as EU RoHS compliant have a maximum concentration of 0.1% by weight in homogenous materials for lead, hexavalent chromium, mercury, PBB, PBDE, DBP, BBP, DEHP, DIBP, and 0.01% for cadmium, or qualify for an exemption to these limits as defined in the Annexes of Directive 2011/65/EU (RoHS2). Finished electrical and electronic equipment products will be CE marked as required by Directive 2011/65/EU. Components may not be CE marked. Additionally, the part numbers that TE has identified as EU ELV compliant have a maximum concentration of 0.1% by weight in homogenous materials for lead, hexavalent chromium, and mercury, and 0.01% for cadmium, or qualify for an exemption to these limits as defined in the Annexes of Directive 2000/53/EC (ELV). Regarding the REACH Regulation, the information TE provides on SVHC in articles for this part number is based on the latest European Chemicals Agency (ECHA) 'Guidance on requirements for substances in articles' posted at this URL: <https://echa.europa.eu/guidance-documents/guidance-on-reach>

Compatible Parts

TE Part # 59824-1
TETRA-CRIMP PIDG PG FASTON 22-10 ASSY

TE Part # 47386
DAHT PG PIDG 26-16 ASSY

TE Part # 58423-1
DIE, RBY IS9252

TE Part # 58433-3
PRO CR ASSY, RBY IS9252

TE Part # 1SET191001R0000
CRIMP-HT

TE Part # 1SET191002R0000
TET CRIMP-HT

TE Part # 169404
CERTI-LOK DIE

Also in the Series | **PIDG**



Compression Connectors(17)



Crimp Terminal Housings(1)



Crimp Wire Pins, Tabs & Ferrules(41)



Hand Crimping Tools(2)



Knife Disconnects(11)



PCB Terminals(7)



Quick Disconnects(49)



Ring Terminals(611)

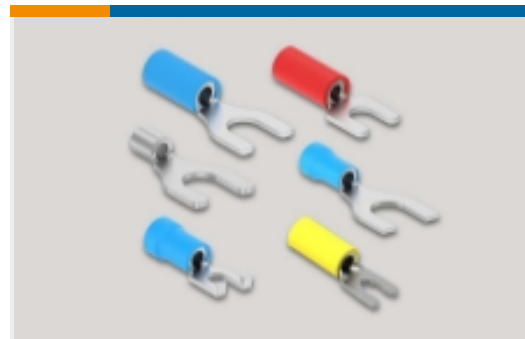

Spade Terminals(233)



Special Purpose Terminals(1)



Splices(46)

Customers Also Bought



TE Part #1-6609031-3
10ER1=F7189



TE Part #61116-4
CMNL PIN 24-18 PTPHBZ

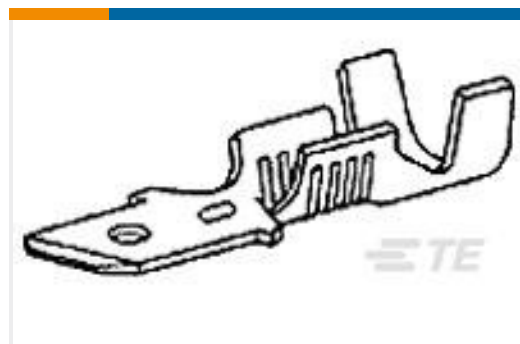

TE Part #42490-3
187 FASTON TAB 22-18 AWG TPBR

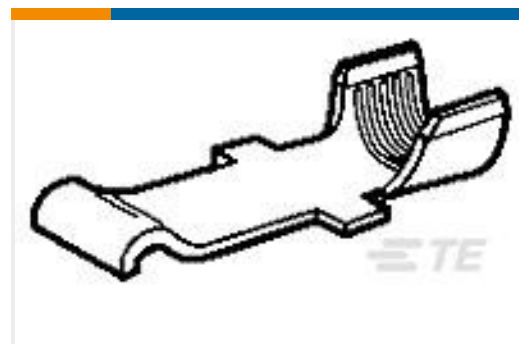

TE Part #54329-1
CONTACT,PWR LK,SRS1,LS PC,SLDR

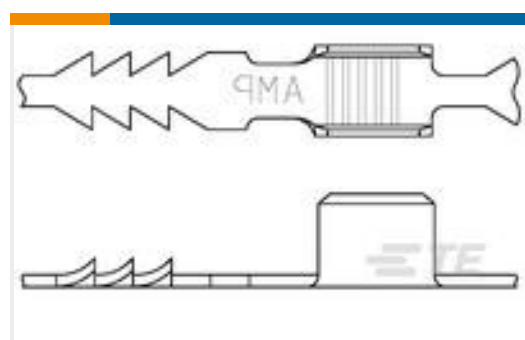

TE Part #62192-1
BOBBIN TAB .016TPBR



TE Part #2-2176337-0
CRGCQ 0402 390R 1%

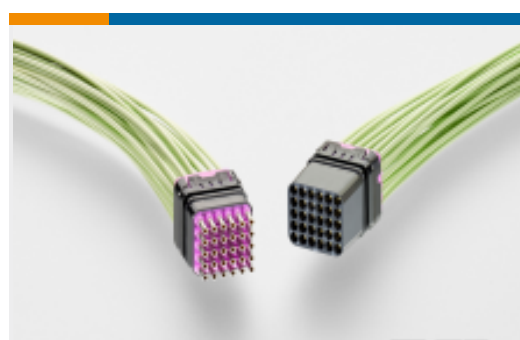

TE Part #ZPF000000000203400
DMC-MR 30-23 SA



TE Part #60419-2
250 FASTON FLAG REC 18-14 AWG TPBR

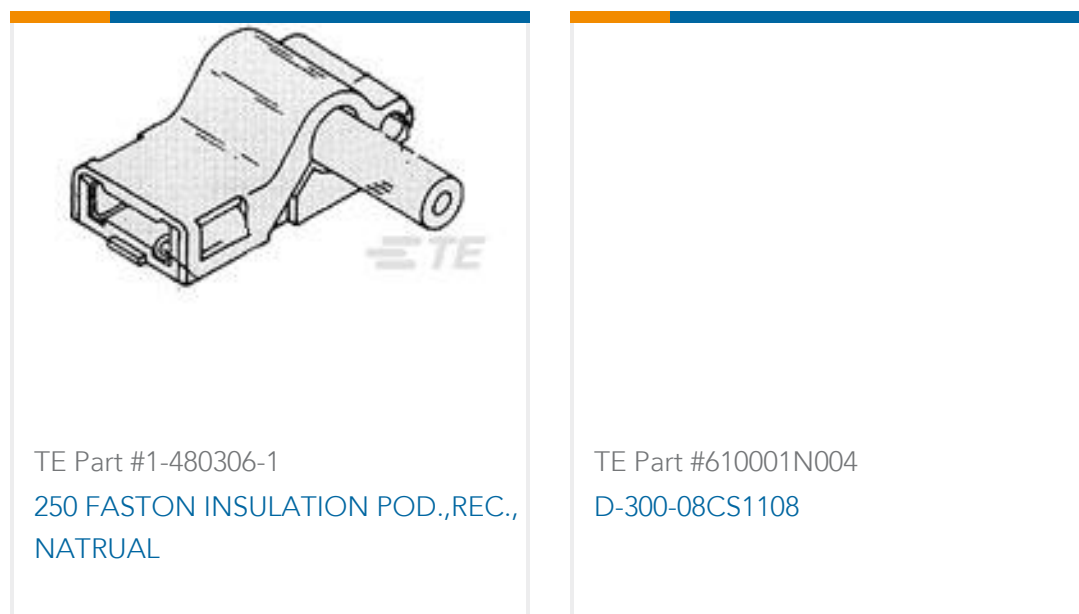

Documents

Product Drawings

[PIDG R 22-16 COMM 22-18 MIL 4](#)

English

CAD Files

Customer View Model

[ENG_CVM_2-31880-1_T.3d_igs.zip](#)

English

Customer View Model

[ENG_CVM_2-31880-1_T.3d_stp.zip](#)

English

Customer View Model

[ENG_CVM_2-31880-1_T.2d_dxf.zip](#)

English

[3D PDF](#)

English

[3D PDF](#)

3D

Customer View Model

[ENG_CVM_CVM_2-31880-1_AA.2d_dxf.zip](#)

English

Customer View Model

[ENG_CVM_CVM_2-31880-1_AA.3d_igs.zip](#)

English

Customer View Model

[ENG_CVM_CVM_2-31880-1_AA.3d_stp.zip](#)

English

By downloading the CAD file I accept and agree to the [Terms and Conditions](#) of use.

Product Specifications

[Application Specification](#)

English

Product Environmental Compliance

[TE Material Declaration](#)

English



[Agency Approvals](#)

[UL Report](#)

English