

2-2399610-2 ✓ ACTIVE

PowerTube | PowerTube HVP-HD 1400

TE Internal #: 2-2399610-2

PCB Mount Header, Bus Bar-to-Wire, 2 Position, Header & Push-Push Assembly, Silver, Through Hole - Screw, Sealable, PowerTube HVP-HD 1400

[View on TE.com >](#)



Connectors > PCB Connectors > PCB Headers & Receptacles

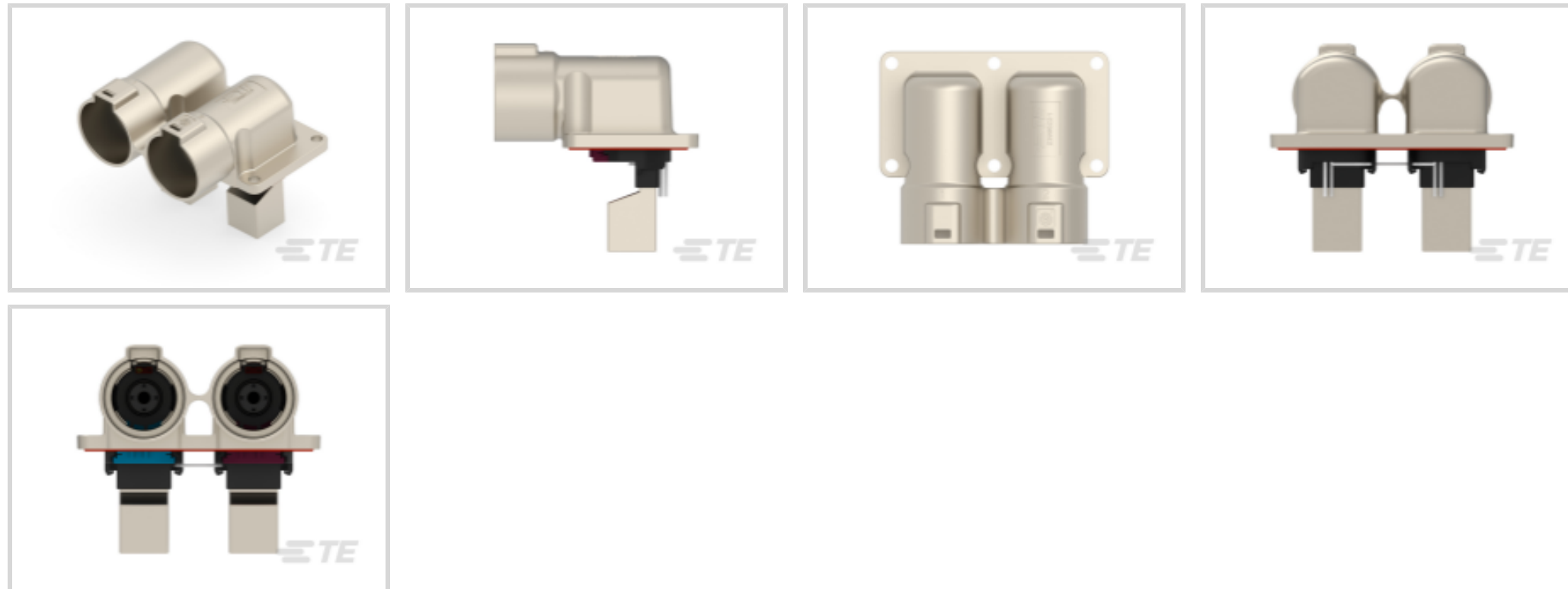

Connector System: **Bus Bar-to-Wire**

Number of Positions: **2**

Number of Rows: **1**

Termination Method to Printed Circuit Board: **Through Hole - Screw**

Header Type: **Header & Push-Push Assembly**

Features

Product Type Features

Connector System	Bus Bar-to-Wire
Header Type	Header & Push-Push Assembly
Sealable	Yes
Connector & Contact Terminates To	Bus Bar
PCB Connector Assembly Type	PCB Mount Header

Configuration Features

Number of Positions	2
Number of Rows	1

Electrical Characteristics

Operating Voltage	1000 VAC
-------------------	----------

Body Features

Primary Product Color	Natural
-----------------------	---------

Contact Features

--	--



Mating Pin Diameter	14 mm[.55 in]
Contact Mating Area Plating Material	Silver
Contact Type	Pin
Contact Current Rating (Max)	500 A

Termination Features

Termination Method to Printed Circuit Board	Through Hole - Screw
---	----------------------

Mechanical Attachment

Mating Alignment Type	Polarization
Connector Mounting Type	Panel Mount

Usage Conditions

Operating Temperature (Max)	140 °C[284 °F]
Operating Temperature Range	-40 – 140 °C[-40 – 284 °F]

Operation/Application

Circuit Application	Power & Signal
---------------------	----------------

Industry Standards

Degree of Protection	IPX9K
UL Flammability Rating	UL 94V-0

Product Compliance

[For compliance documentation, visit the product page on TE.com>](#)

EU RoHS Directive 2011/65/EU	Compliant
EU ELV Directive 2000/53/EC	Compliant
China RoHS 2 Directive MIIT Order No 32, 2016	No Restricted Materials Above Threshold
EU REACH Regulation (EC) No. 1907/2006	Current ECHA Candidate List: JUNE 2023 (235) Candidate List Declared Against: JUNE 2022 (224) SVHC > Threshold: Dodecamethylcyclhexasiloxane (D6) (.11% in Component Part) Decamethylcyclopentasiloxane (D5) (.11% in Component Part) Article Safe Usage Statements: Wash thoroughly after handling. Recycle if possible and dispose of the article by following all applicable governmental regulations relevant to your geographic location.
Halogen Content	Not Yet Reviewed for halogen content
Solder Process Capability	Not reviewed for solder process capability

Product Compliance Disclaimer

This information is provided based on reasonable inquiry of our suppliers and represents our current actual knowledge based on the information they provided. This information is subject to change. The part numbers that TE has identified as EU RoHS compliant have a maximum concentration of 0.1% by weight in homogenous materials for lead, hexavalent chromium, mercury, PBB, PBDE, DBP, BBP, DEHP, DIBP, and 0.01% for cadmium, or qualify for an exemption to these limits as defined in the Annexes of Directive 2011/65/EU (RoHS2). Finished electrical and electronic equipment products will be CE marked as required by Directive 2011/65/EU. Components may not be CE marked. Additionally, the part numbers that TE has identified as EU ELV compliant have a maximum concentration of 0.1% by weight in homogenous materials for lead, hexavalent chromium, and mercury, and 0.01% for cadmium, or qualify for an exemption to these limits as defined in the Annexes of Directive 2000/53/EC (ELV). Regarding the REACH Regulation, the information TE provides on SVHC in articles for this part number is based on the latest European Chemicals Agency (ECHA) 'Guidance on requirements for substances in articles' posted at this URL: <https://echa.europa.eu/guidance-documents/guidance-on-reach>

Compatible Parts



TE Part # 1-2399663-1
Pre-ASSY,Finger Access,Code K



TE Part # 1-2399663-2
Pre-ASSY,Finger Access,Code L



TE Part # 1-2399663-3
Pre-ASSY,Finger Access,Code M



TE Part # 2-2399663-1
Pre-ASSY,Tool Access,Code A



TE Part # 2-2399663-2
Pre-ASSY,Tool Access,Code B



TE Part # 2-2399663-3
Pre-ASSY,Tool Access,Code C



TE Part # 2-2399663-4
Pre-ASSY,Tool Access,Code D



TE Part # 2-2399663-5
Pre-ASSY,Tool Access,Code E



TE Part # 2-2399663-6
Pre-ASSY,Tool Access,Code F



TE Part # 2-2399663-7
Pre-ASSY,Tool Access,Code G



TE Part # 2-2399663-8
Pre-ASSY,Tool Access,Code H



TE Part # 2-2399663-9
Pre-ASSY,Tool Access,Code J



Also in the Series | **PowerTube HVP-HD 1400**

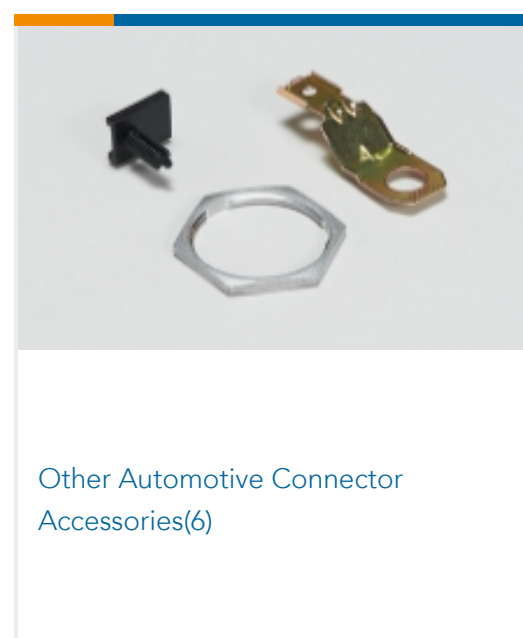
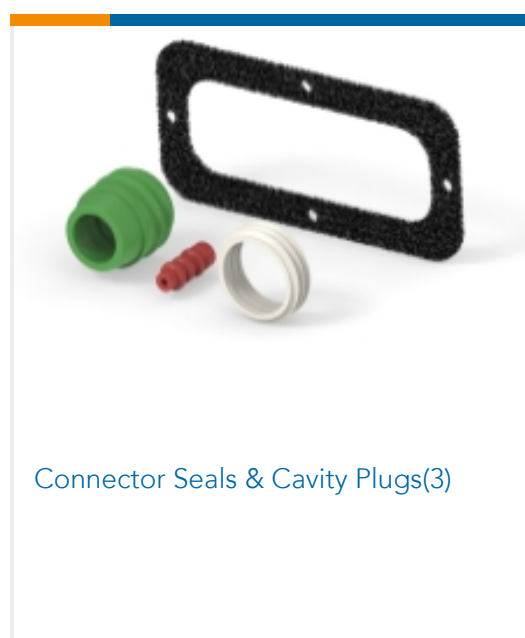
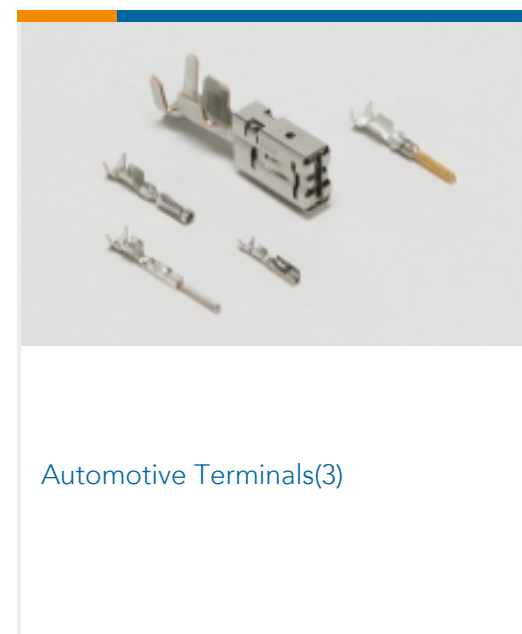
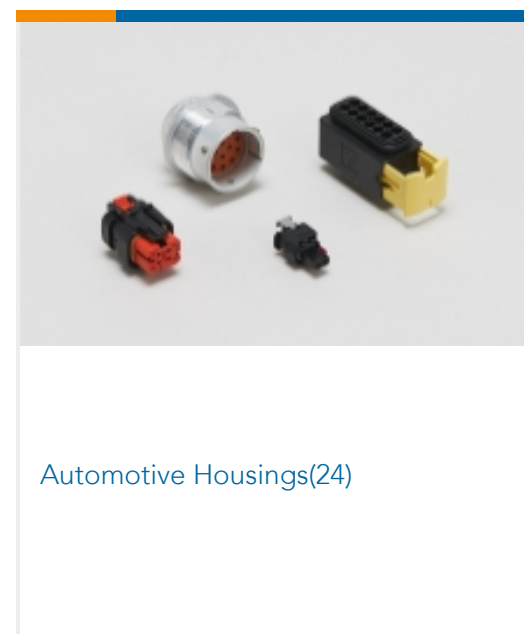
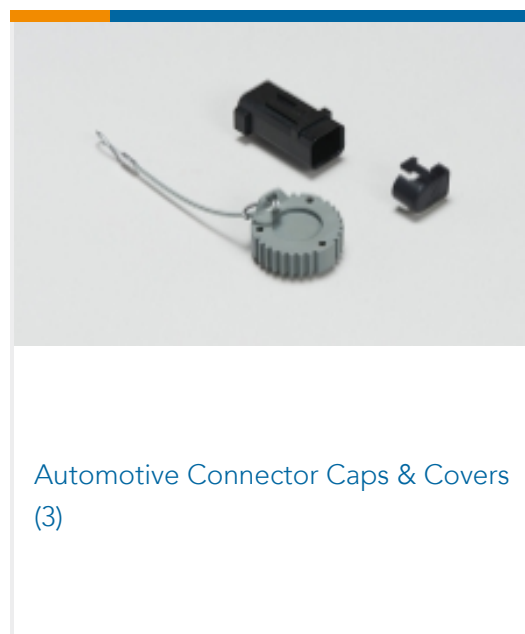

Customers Also Bought

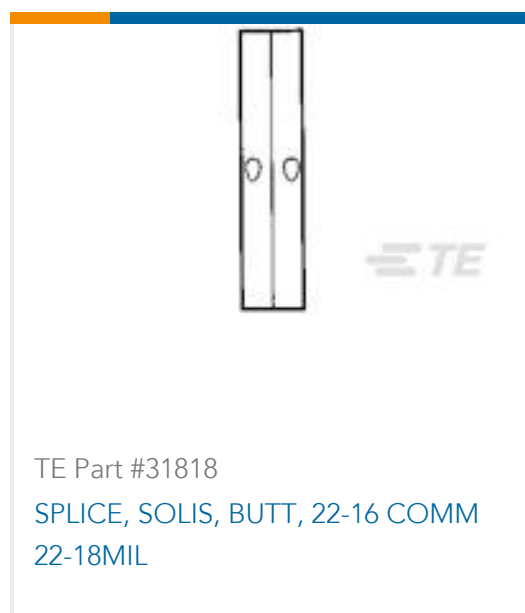



Documents

Product Drawings

2POS,HVP1400,ASSY,90DEG,COD C/D

English

CAD Files

Customer View Model

[ENG_CVM_CVM_2-2399610-2_B.3d_igs.zip](#)

English

Customer View Model

[ENG_CVM_CVM_2-2399610-2_B.3d_stp.zip](#)

English

Customer View Model

[ENG_CVM_CVM_2-2399610-2_B.2d_dxf.zip](#)

English

3D PDF

3D

By downloading the CAD file I accept and agree to the [Terms and Conditions](#) of use.

Datasheets & Catalog Pages

HIVONEX CONNECTORS & CHARGING SOLUTIONS

English

Product Specifications

Application Specification

English