



Alcoswitch | Alcoswitch DIP EDSP

TE Internal #: 2-2319764-0

DIP & SIP Switches, Switch, Gold Flash, Black Housing, High Temperature Nylon, 10 Switch, -20 – 85 °C, DIP Switch, Alcoswitch DIP EDSP

[View on TE.com >](#)

Relays, Contactors & Switches > Switches > DIP & SIP Switches

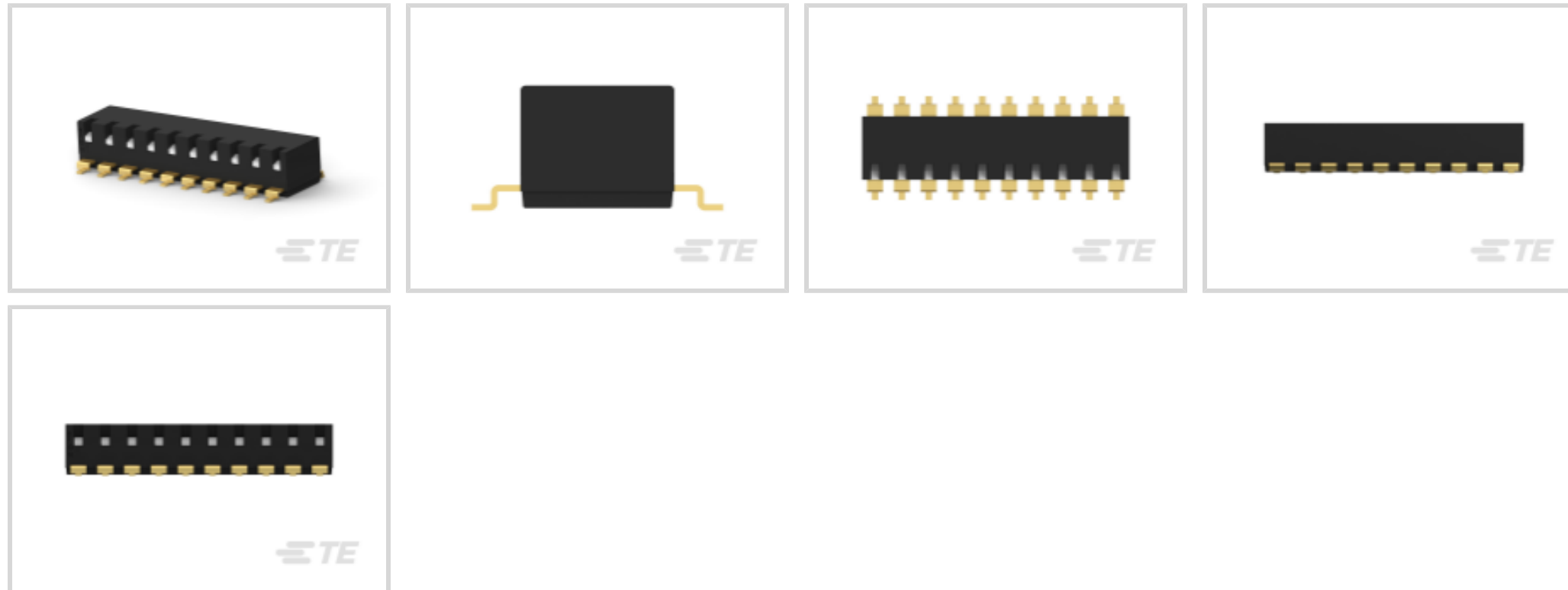

DIP & SIP Switch Product Type: **Switch**

DIP & SIP Switch Contact Mating Area Plating Material: **Gold Flash**

DIP & SIP Switch Housing Color: **Black**

DIP & SIP Switch Housing Material: **High Temperature Nylon**

Sealed DIP & SIP Switch: **No**

## Features

### Product Type Features

DIP & SIP Switch Product Type	Switch
Sealed DIP & SIP Switch	No
DIP & SIP Switch Type	DIP Switch
Actuator Style	Piano (Side Actuated)

### Configuration Features

Number of Positions	10
Number of Switches	10
Configuration (Pole-Throw)	Single Pole - Single Throw

### Electrical Characteristics

DIP & SIP Switch Voltage Rating	24 VDC
---------------------------------	--------

### Body Features

Actuator Color	White
----------------	-------

### Contact Features

--	--

Solder Tail Contact Plating	Gold Flash over Nickel
Shunt Type	DIP
DIP & SIP Switch Contact Mating Area Plating Material	Gold Flash
DIP & SIP Switch Contact Current Rating	.025 A
Contact Base Material	Copper Alloy

### Mechanical Attachment

Mounting Angle	Vertical
DIP & SIP Switch Mounting Type	Surface Mount

### Housing Features

DIP & SIP Switch Housing Color	Black
DIP & SIP Switch Housing Material	High Temperature Nylon
DIP & SIP Switch Centerline	2.54 mm[.1 in]

### Dimensions

Length	25.3 mm[.996 in]
Height	5 mm[.197 in]

### Usage Conditions

Operating Temperature Range	-20 – 85 °C
-----------------------------	-------------

### Packaging Features

Packaging Method	Tube
Packaging Quantity	18

### Product Compliance

[For compliance documentation, visit the product page on TE.com>](#)

EU RoHS Directive 2011/65/EU	Compliant
EU ELV Directive 2000/53/EC	Not Yet Reviewed
China RoHS 2 Directive MIIT Order No 32, 2016	No Restricted Materials Above Threshold
EU REACH Regulation (EC) No. 1907/2006	Current ECHA Candidate List: JUNE 2023 (235) Candidate List Declared Against: JUNE 2022 (224) Does not contain REACH SVHC
Halogen Content	Not Yet Reviewed for halogen content
Solder Process Capability	Not reviewed for solder process capability

## Product Compliance Disclaimer

This information is provided based on reasonable inquiry of our suppliers and represents our current actual knowledge based on the information they provided. This information is subject to change. The part numbers that TE has identified as EU RoHS compliant have a maximum concentration of 0.1% by weight in homogenous materials for lead, hexavalent chromium, mercury, PBB, PBDE, DBP, BBP, DEHP, DIBP, and 0.01% for cadmium, or qualify for an exemption to these limits as defined in the Annexes of Directive 2011/65/EU (RoHS2). Finished electrical and electronic equipment products will be CE marked as required by Directive 2011/65/EU. Components may not be CE marked. Additionally, the part numbers that TE has identified as EU ELV compliant have a maximum concentration of 0.1% by weight in homogenous materials for lead, hexavalent chromium, and mercury, and 0.01% for cadmium, or qualify for an exemption to these limits as defined in the Annexes of Directive 2000/53/EC (ELV). Regarding the REACH Regulation, the information TE provides on SVHC in articles for this part number is based on the latest European Chemicals Agency (ECHA) 'Guidance on requirements for substances in articles' posted at this URL: <https://echa.europa.eu/guidance-documents/guidance-on-reach>

## Compatible Parts

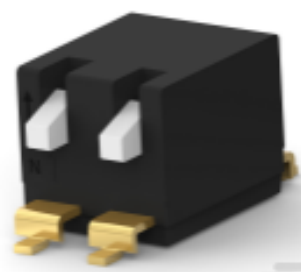

TE Part # 4-2319764-1  
E STACK PIANO 2P G LONG T&R PD OFF

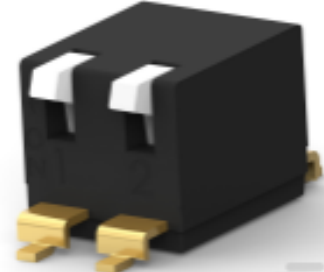

TE Part # 3-2319764-1  
E STACK PIANO 2P G LONG T&R PD ON

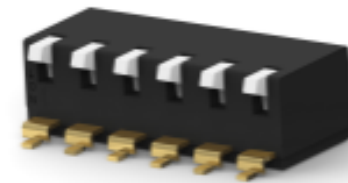

TE Part # 3-2319764-3  
E STACK PIANO 6P G LONG T&R PD ON

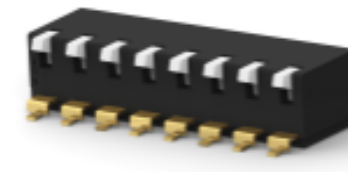

TE Part # 2319764-4  
E STACK PIANO 8P G LONG TUBE PD ON

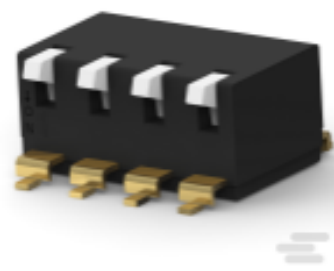

TE Part # 2319764-2  
E STACK PIANO 4P G LONG TUBE PD ON

## Also in the Series | Alcoswitch DIP EDSP

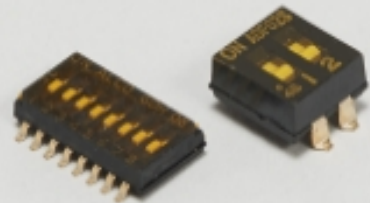

DIP & SIP Switches(58)

## Customers Also Bought

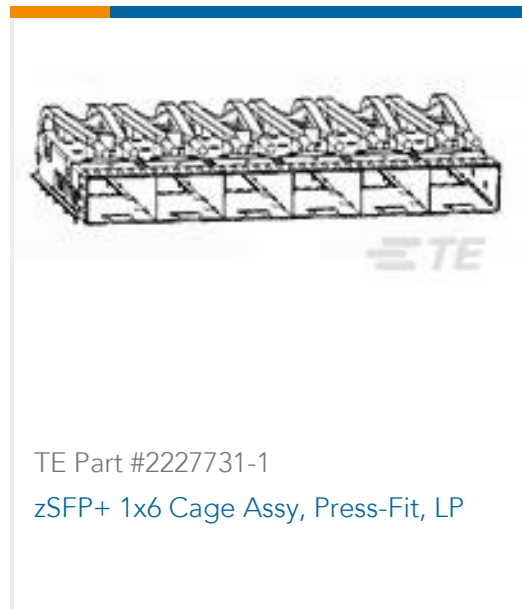
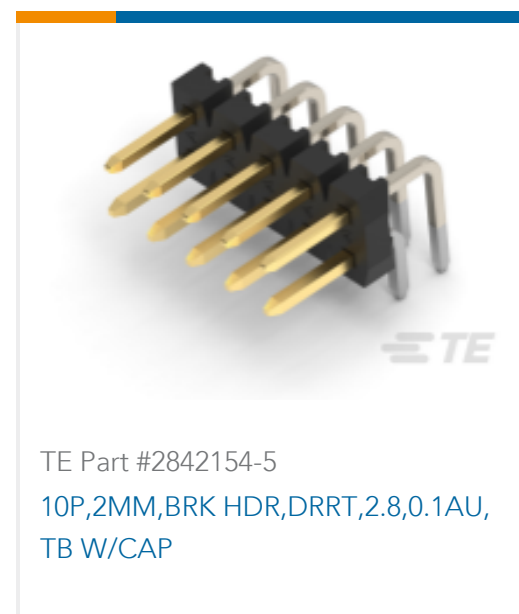

## Documents

### Product Drawings

[E STACK PIANO 10P G SHORT TUBE PD OFF](#)

English

### CAD Files

[3D PDF](#)

3D

Customer View Model

[ENG\\_CVM\\_CVM\\_2-2319764-0\\_A.2d\\_dxf.zip](#)

English

Customer View Model

[ENG\\_CVM\\_CVM\\_2-2319764-0\\_A.3d\\_igs.zip](#)

English

Customer View Model

[ENG\\_CVM\\_CVM\\_2-2319764-0\\_A.3d\\_stp.zip](#)

English

By downloading the CAD file I accept and agree to the [Terms and Conditions](#) of use.

### Datasheets & Catalog Pages

[SWITCHES\\_CORE\\_PROGRAM\\_CATALOG](#)

English