

2-1971030-3 ✓ ACTIVE



GRACE INERTIA 2.0

TE Internal #: 2-1971030-3

Rectangular Connector Housings, Wire-to-Board, 3 Position, .079 in [2 mm] Centerline, 1 Row, Nylon 66 GF, Plug, Socket, GRACE INERTIA 2.0

[View on TE.com >](#)

Connectors > Rectangular Connectors > Rectangular Connector Housings > STD Temp Sig GRACE INERTIA Plug

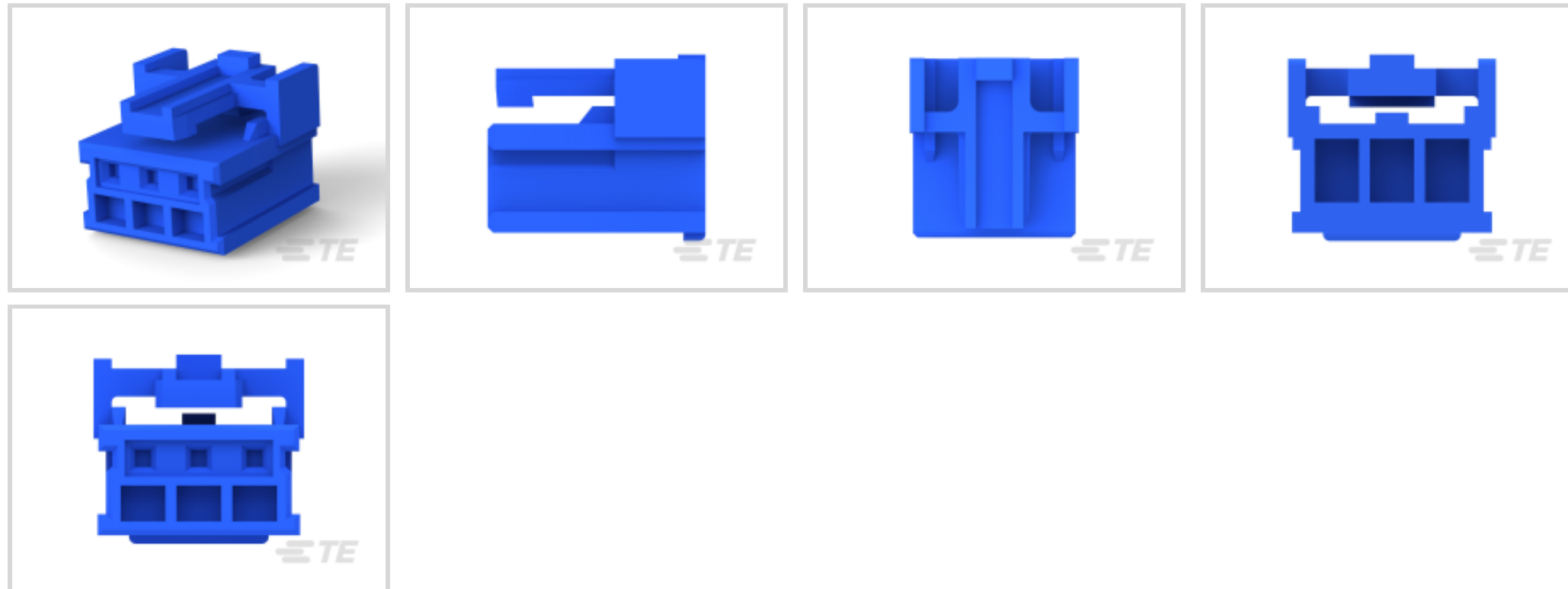

Connector System: **Wire-to-Board**

Number of Positions: **3**

Centerline (Pitch): **2 mm [.079 in]**

Number of Rows: **1**

Housing Material: **Nylon 66 GF**

[All STD Temp Sig GRACE INERTIA Plug \(63\)](#)

Features

Product Type Features

Connector System	Wire-to-Board
Connector & Housing Type	Plug
Sealable	No
Connector & Contact Terminates To	Wire & Cable

Configuration Features

Number of Cavities	3
Number of Positions	3
Number of Rows	1

Electrical Characteristics

Operating Voltage	50 VAC
-------------------	--------

Contact Features

Contact Layout	Inline
----------------	--------



Contact Type	Socket
--------------	--------

Mechanical Attachment

Connector Mounting Type	Cable Mount (Free-Hanging)
-------------------------	----------------------------

Housing Features

Housing Color	Blue
---------------	------

Centerline (Pitch)	2 mm[.079 in]
--------------------	---------------

Housing Material	Nylon 66 GF
------------------	-------------

Dimensions

Connector Height	7.9 mm[.311 in]
------------------	-----------------

Product Width	6.75 mm[.266 in]
---------------	------------------

Product Length	7.54 mm[.297 in]
----------------	------------------

Usage Conditions

Operating Temperature Range	-30 – 105 °C[-22 – 221 °F]
-----------------------------	----------------------------

Operation/Application

Halogen Free	No
--------------	----

Circuit Application	Signal
---------------------	--------

Identification Marking

Circuit Identification Feature	Without
--------------------------------	---------

Packaging Features

Packaging Quantity	600
--------------------	-----

Packaging Method	Package
------------------	---------

Product Compliance

[For compliance documentation, visit the product page on TE.com>](#)

EU RoHS Directive 2011/65/EU	Compliant
------------------------------	-----------

EU ELV Directive 2000/53/EC	Compliant
-----------------------------	-----------

China RoHS 2 Directive MIIT Order No 32, 2016	No Restricted Materials Above Threshold
---	---

EU REACH Regulation (EC) No. 1907/2006	Current ECHA Candidate List: JUNE 2023 (235) Candidate List Declared Against: JUNE 2023 (235) Does not contain REACH SVHC
--	---

Halogen Content	Not Low Halogen - contains Br or Cl > 900 ppm.
-----------------	--



Solder Process Capability

Not applicable for solder process capability

Product Compliance Disclaimer

This information is provided based on reasonable inquiry of our suppliers and represents our current actual knowledge based on the information they provided. This information is subject to change. The part numbers that TE has identified as EU RoHS compliant have a maximum concentration of 0.1% by weight in homogenous materials for lead, hexavalent chromium, mercury, PBB, PBDE, DBP, BBP, DEHP, DIBP, and 0.01% for cadmium, or qualify for an exemption to these limits as defined in the Annexes of Directive 2011/65/EU (RoHS2). Finished electrical and electronic equipment products will be CE marked as required by Directive 2011/65/EU. Components may not be CE marked. Additionally, the part numbers that TE has identified as EU ELV compliant have a maximum concentration of 0.1% by weight in homogenous materials for lead, hexavalent chromium, and mercury, and 0.01% for cadmium, or qualify for an exemption to these limits as defined in the Annexes of Directive 2000/53/EC (ELV). Regarding the REACH Regulation, the information TE provides on SVHC in articles for this part number is based on the latest European Chemicals Agency (ECHA) 'Guidance on requirements for substances in articles' posted at this URL: <https://echa.europa.eu/guidance-documents/guidance-on-reach>

Compatible Parts



TE Part # CAT-G7534A-P729
STD Temp Sig GRACE INERTIA Plug



TE Part # CAT-G7534A-C1701
STD Temp Sig GRACE INERTIA Cap



TE Part # 1903392-1
GIC 2.5 W CAP HSG 3P NATURAL



TE Part # 2-2367943-3
GI2.0EV VT SMT Poting HDR,BLU,Key C,3P

Also in the Series | GRACE INERTIA 2.0



PCB Headers & Receptacles(70)



Rectangular Connector Housings(20)



Standard Rectangular Connectors(18)



Wire-to-Board Connector Assemblies & Housings(1)



Wire-to-Board Connector Contacts(3)

Customers Also Bought

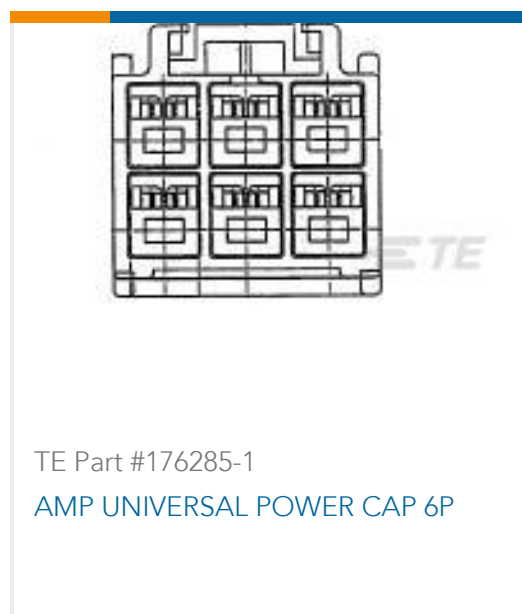

TE Part #176285-1
AMP UNIVERSAL POWER CAP 6P



TE Part #1-350867-0
01P UMNL PLUG HSG NATL



TE Part #770421-1
01P UMNL CAP HSG NATL



TE Part #175149-1
UNIVERSAL POWER CONN TAB



TE Part #172074-1
187 HSG. PLMKII REC. NAT



TE Part #170325-1
187 PL MKII REC. 20-16AWG PTBR

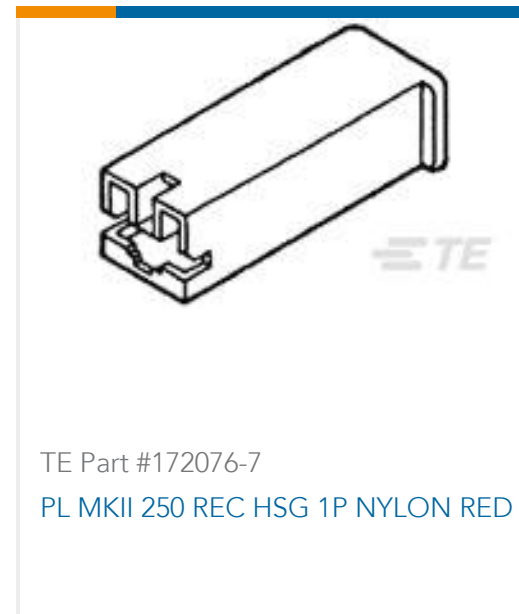

TE Part #172076-7
PL MKII 250 REC HSG 1P NYLON RED

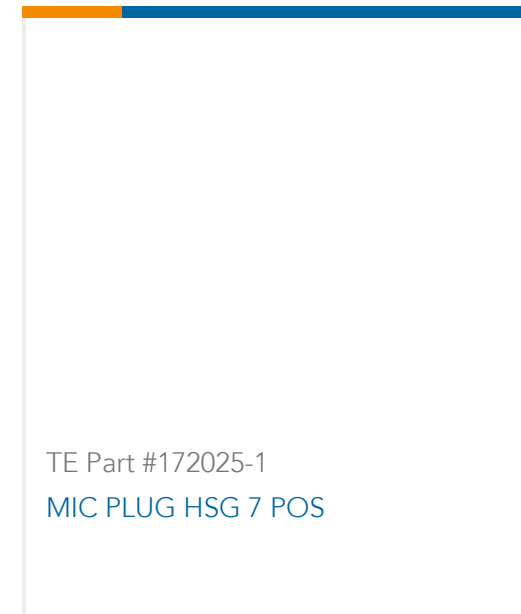

TE Part #172025-1
MIC PLUG HSG 7 POS

Documents

Product Drawings

3POS Plug Housing for GIC 2.0 EV Series

English

CAD Files

3D PDF

3D

Customer View Model

[ENG_CVM_CVM_2-1971030-3_F_c-2-1971030-3-f.2d_dxf.zip](#)

English

Customer View Model

[ENG_CVM_CVM_2-1971030-3_F_c-2-1971030-3-f.3d_igs.zip](#)

English

Customer View Model

[ENG_CVM_CVM_2-1971030-3_F_c-2-1971030-3-f.3d_stp.zip](#)

English

By downloading the CAD file I accept and agree to the [Terms and Conditions](#) of use.

Product Specifications

Application Specification

English

Product Environmental Compliance

TE Material Declaration

English