



VAL-U-LOK

TE Internal #: 2-1969613-4

Rectangular Power Connectors, Housing, Plug, Wire-to-Wire / Wire-to-Panel, 24 Position, 4.2 mm [.165 in] Centerline, Wire & Cable, UL 94V-0

[View on TE.com >](#)

Connectors > Power Connectors > Rectangular Power > Rectangular Power Connectors



Rectangular Power Connector Type: **Housing**

Connector & Housing Type: **Plug**

Connector System: **Wire-to-Panel, Wire-to-Wire**

Number of Positions: **24**

Centerline (Pitch): **4.2 mm [.165 in]**

Features

Product Type Features

Rectangular Power Connector Type	Housing
Connector & Housing Type	Plug
Connector System	Wire-to-Panel, Wire-to-Wire
Sealable	No
Connector & Contact Terminates To	Wire & Cable

Configuration Features

Number of Positions	24
Number of Rows	2

Electrical Characteristics

Operating Voltage	600 VAC
-------------------	---------

Contact Features

Contact Retention Within Housing	Without
Contact Type	Pin



Termination Features

Termination Method to Wire & Cable	Crimp
------------------------------------	-------

Mechanical Attachment

Connector Mounting Type	Panel Mount
-------------------------	-------------

Housing Features

Centerline (Pitch)	4.2 mm [.165 in]
--------------------	------------------

Housing Color	Natural
---------------	---------

Housing Material	Nylon 6/6
------------------	-----------

Dimensions

Connector Height	11.6 mm [.457 in]
------------------	-------------------

Product Width	23.8 mm [.906 in]
---------------	-------------------

Product Length	51.6 mm [2.031 in]
----------------	--------------------

Row-to-Row Spacing	4.2 mm [.165 in]
--------------------	------------------

Usage Conditions

Operating Temperature Range	-40 – 105 °C [-40 – 221 °F]
-----------------------------	-----------------------------

Operation/Application

Circuit Application	Power & Signal
---------------------	----------------

Industry Standards

CSA Rating	208567
------------	--------

UL Rating	Recognized
-----------	------------

Agency/Standard	CSA, UL
-----------------	---------

Approved Standards	UL E28476
--------------------	-----------

UL Flammability Rating	UL 94V-0
------------------------	----------

Glow Wire Rating	Standard Part - Not Glow Wire
------------------	-------------------------------

Packaging Features

Packaging Quantity	500
--------------------	-----

Packaging Method	Bag
------------------	-----

Product Compliance

For compliance documentation, visit the product page on [TE.com](https://www.te.com)>

EU RoHS Directive 2011/65/EU	Compliant
------------------------------	-----------

EU ELV Directive 2000/53/EC	Compliant
-----------------------------	-----------





China RoHS 2 Directive MIIT Order No 32, 2016	No Restricted Materials Above Threshold
EU REACH Regulation (EC) No. 1907/2006	Current ECHA Candidate List: JUNE 2023 (235) Candidate List Declared Against: JAN 2023 (233) Does not contain REACH SVHC
Halogen Content	Low Halogen - Br, Cl, F, I < 900 ppm per homogenous material. Also BFR/CFR/PVC Free
Solder Process Capability	Not reviewed for solder process capability

Product Compliance Disclaimer

This information is provided based on reasonable inquiry of our suppliers and represents our current actual knowledge based on the information they provided. This information is subject to change. The part numbers that TE has identified as EU RoHS compliant have a maximum concentration of 0.1% by weight in homogenous materials for lead, hexavalent chromium, mercury, PBB, PBDE, DBP, BBP, DEHP, DIBP, and 0.01% for cadmium, or qualify for an exemption to these limits as defined in the Annexes of Directive 2011/65/EU (RoHS2). Finished electrical and electronic equipment products will be CE marked as required by Directive 2011/65/EU. Components may not be CE marked. Additionally, the part numbers that TE has identified as EU ELV compliant have a maximum concentration of 0.1% by weight in homogenous materials for lead, hexavalent chromium, and mercury, and 0.01% for cadmium, or qualify for an exemption to these limits as defined in the Annexes of Directive 2000/53/EC (ELV). Regarding the REACH Regulation, the information TE provides on SVHC in articles for this part number is based on the latest European Chemicals Agency (ECHA) 'Guidance on requirements for substances in articles' posted at this URL: <https://echa.europa.eu/guidance-documents/guidance-on-reach>

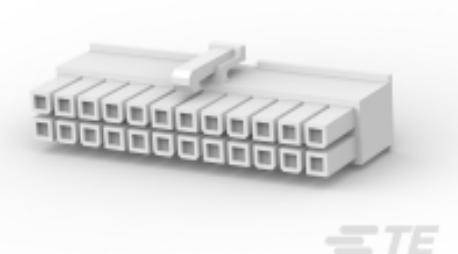
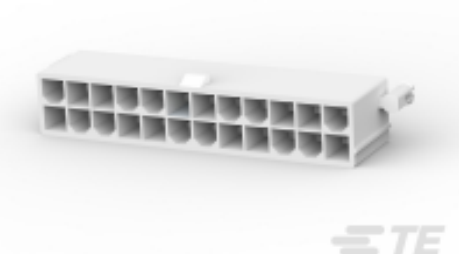
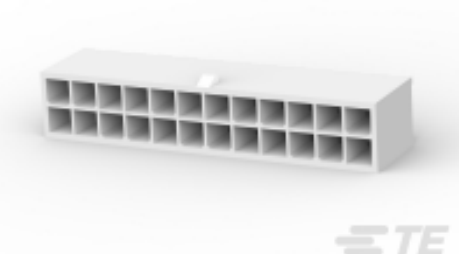
Compatible Parts

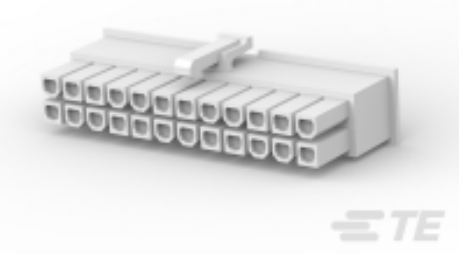
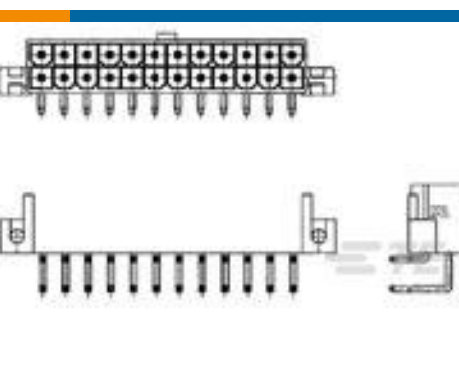
 <p>TE Part # 2-1586019-4 24P RCPT VAL-U-LOK V0</p>	 <p>TE Part # 2-1586040-4 24P VAL-U-LOK VRT HDR W/P V0</p>	 <p>TE Part # 2-1586038-4 24P VRT HDR VAL-U-LOK V0</p>	 <p>TE Part # 2-1586042-4 24P VAL-U-LOK R/A HDR V0</p>
 <p>TE Part # 2-1586587-4 24P VAL-U-LOK BMI VRT HDR V0</p>	 <p>TE Part # 2-1969614-4 24P RCPT VAL-U-LOK V0</p>	 <p>TE Part # 2-1586044-4 24P VAL-U-LOK R/A HDR SCRMT V0</p>	

Customers Also Bought

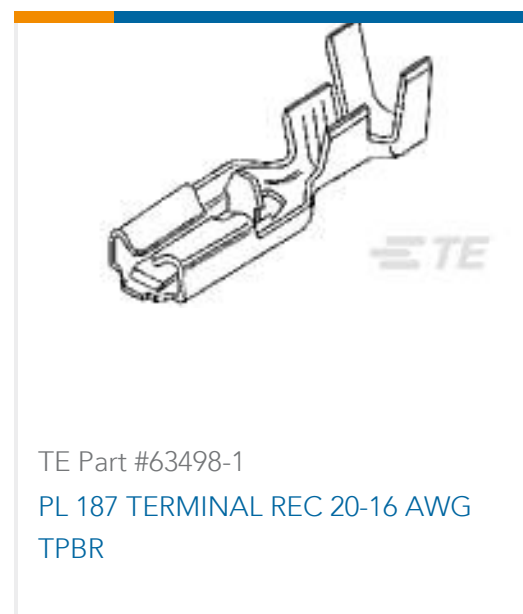

Documents

Product Drawings

[24P PM PLUG VAL-U-LOK V0](#)

English

CAD Files

[3D PDF](#)

3D

Customer View Model

[ENG_CVM_CVM_2-1969613-4_A_c-2-1969613-4-a.2d_dxf.zip](#)

English

Customer View Model

[ENG_CVM_CVM_2-1969613-4_A_c-2-1969613-4-a.3d_igs.zip](#)

English

Customer View Model

[ENG_CVM_CVM_2-1969613-4_A_c-2-1969613-4-a.3d_stp.zip](#)

English

By downloading the CAD file I accept and agree to the [Terms and Conditions](#) of use.

Datasheets & Catalog Pages



[1-1773730-3 VAL-U-LOK Connectors with TPA Flyer](#)

English

[Product Specifications](#)

[Application Specification](#)

English

[Instruction Sheets](#)

[Instruction Sheet \(U.S.\)](#)

English

[Agency Approvals](#)

[UL Report](#)

English