

1SNK705310R0000 ✓ ACTIVE

ENTRELEC | ENTRELEC SNK

TE Internal #: 1SNK705310R0000

Modular Terminal Blocks, Disconnect, PI-Spring Terminal Block,
Gray, Product Spacing .205 in [5.2 mm], 2 Position, DIN Rail,
ENTRELEC SNK

[View on TE.com >](#)



Connectors > Terminal Blocks & Strips > Modular Terminal Blocks



Block Function: **Disconnect**

Modular Terminal Block Product Type: **PI-Spring Terminal Block**

Primary Product Color: **Gray**

Product Spacing: **5.2 mm [.205 in]**

Number of Positions: **2**

Features

Product Type Features

Modular Terminal Block Product Type	PI-Spring Terminal Block
-------------------------------------	--------------------------

Configuration Features

Gauge Type	A2 / 2.3 mm Dia.
Number of Levels	1
Number of Circuits	1
Block Function	Disconnect
Number of Positions	2

Electrical Characteristics

Operating Voltage Rating (UL & CSA) (Max) - Main Circuit	300 V
Impulse Withstanding Voltage Rating (IEC)	6000 V
Voltage Rating (CSA)	300 V
Current Rating (CSA)	14 A
Power Loss	1.6 W
Short-Time Withstanding Current Rating @ 1s	300 A

Voltage Rating (IEC)	630 V
Current Rating (UL)	20 A
Current Rating (IEC)	20 A

Body Features

Product Weight	8.1 g[.319 oz]
Primary Product Color	Gray

Mechanical Attachment

DIN Rail Mounting Type	TH35-15, TH35-7.5
Connector Mounting Type	DIN Rail

Housing Features

Housing Material	Polyamide
------------------	-----------

Dimensions

Main Circuit Capacity - 1 Rigid Stranded Conductor per Spring Clamp	.2 – 4 mm ²
Main Circuit Capacity - Twin Ferrule per Spring Clamp	.22 – .5 mm ²
Wire Stripping Length	11 mm[.433 in]
Main Circuit Capacity - 1 Non-Insulated Ferrule per Spring Clamp	.22 – 2.5 mm ²
Main Circuit Capacity - 1 Insulated Ferrule per Spring Clamp	26 – 14 AWG
Main Circuit Capacity - 1 Flexible Conductor per Spring Clamp	.22 – 2.5 mm ²
Tool Size	3.5 mm[.138 in]
Product Depth	44.2 mm
Product Length	44.2 mm
Product Height	65.3 mm
Product Spacing	5.2 mm[.205 in]

Usage Conditions

Installation Temperature Range	-5 – 40 °C[23 – 104 °F]
Operating Temperature Range	-55 – 110 °C[-67 – 230 °F]

Industry Standards

IP Rating	IP20
UL Flammability Rating	UL 94V-0

Product Compliance

For compliance documentation, visit the product page on [TE.com](https://www.te.com)>











EU RoHS Directive 2011/65/EU	Compliant
EU ELV Directive 2000/53/EC	Compliant
China RoHS 2 Directive MIIT Order No 32, 2016	No Restricted Materials Above Threshold
EU REACH Regulation (EC) No. 1907/2006	Current ECHA Candidate List: JUNE 2023 (235) Candidate List Declared Against: JUNE 2023 (235) Does not contain REACH SVHC
Halogen Content	Low Halogen - Br, Cl, F, I < 900 ppm per homogenous material. Also BFR/CFR/PVC Free
Solder Process Capability	Not reviewed for solder process capability

Product Compliance Disclaimer

This information is provided based on reasonable inquiry of our suppliers and represents our current actual knowledge based on the information they provided. This information is subject to change. The part numbers that TE has identified as EU RoHS compliant have a maximum concentration of 0.1% by weight in homogenous materials for lead, hexavalent chromium, mercury, PBB, PBDE, DBP, BBP, DEHP, DIBP, and 0.01% for cadmium, or qualify for an exemption to these limits as defined in the Annexes of Directive 2011/65/EU (RoHS2). Finished electrical and electronic equipment products will be CE marked as required by Directive 2011/65/EU. Components may not be CE marked. Additionally, the part numbers that TE has identified as EU ELV compliant have a maximum concentration of 0.1% by weight in homogenous materials for lead, hexavalent chromium, and mercury, and 0.01% for cadmium, or qualify for an exemption to these limits as defined in the Annexes of Directive 2000/53/EC (ELV). Regarding the REACH Regulation, the information TE provides on SVHC in articles for this part number is based on the latest European Chemicals Agency (ECHA) 'Guidance on requirements for substances in articles' posted at this URL: <https://echa.europa.eu/guidance-documents/guidance-on-reach>

Compatible Parts

 <p>TE Part # 1SET111002R0000 WF005-08-WH</p>	 <p>TE Part # 1SET111005R0000 WF010-08-RD</p>	 <p>TE Part # 1SET111007R0000 WF015-08-BK</p>	 <p>TE Part # 1SET111010R0000 WF025-08-GR</p>
 <p>TE Part # 1SET111027R0000 WF007-08-GR</p>	 <p>TE Part # 1SET111029R0000 WF025-08-BL</p>	 <p>TE Part # 1SNK140004R0000 MC512-YL</p>	 <p>TE Part # 1SNK705911R0000 EK2.5-3P</p>



Also in the Series | **ENTRELEC SNK**

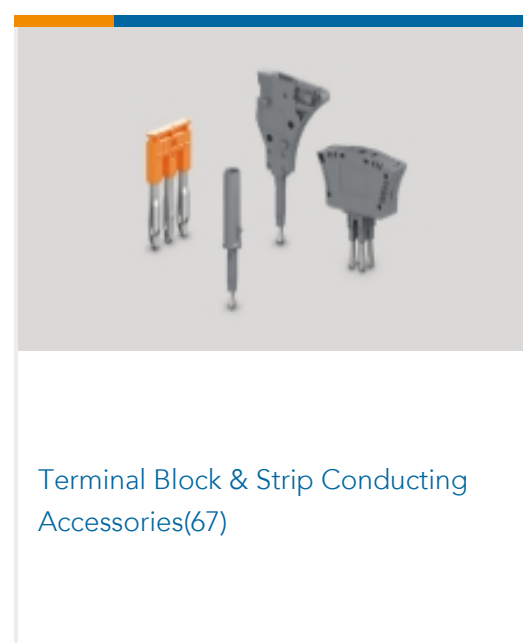

Customers Also Bought



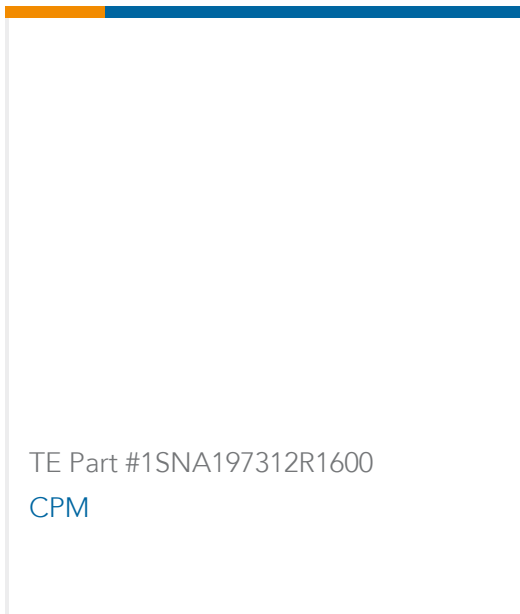
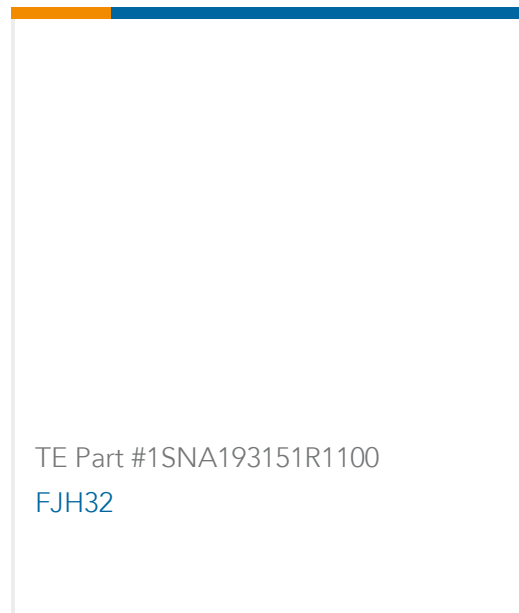
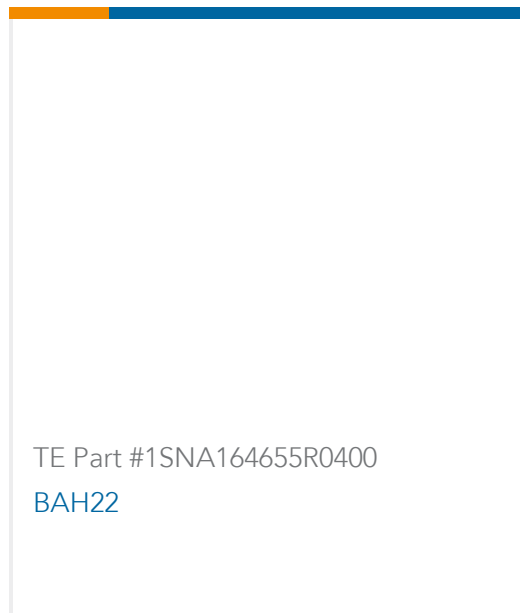
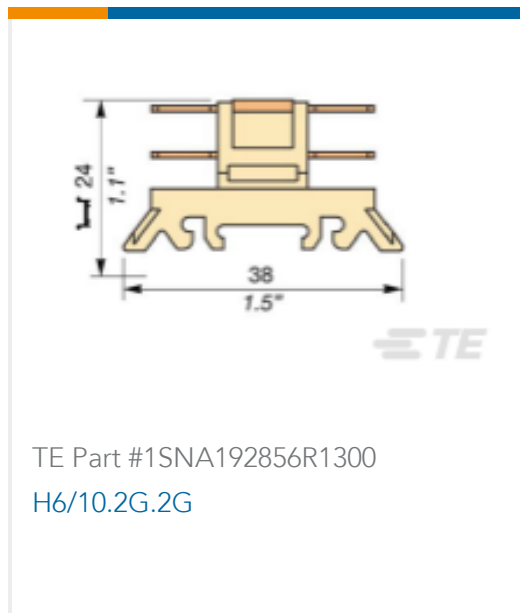

Documents

CAD Files

[3D PDF](#)

[3D](#)

[Customer View Model](#)

[ENG_CVM_CVM_1SNK705310R0000_A.2d_dxf.zip](#)

English

[Customer View Model](#)

[ENG_CVM_CVM_1SNK705310R0000_A.3d_igs.zip](#)

English

[Customer View Model](#)

[ENG_CVM_CVM_1SNK705310R0000_A.3d_stp.zip](#)

English

By downloading the CAD file I accept and agree to the [Terms and Conditions](#) of use.

Datasheets & Catalog Pages

[ENTRELEC Terminal Block - Master Catalog](#)

[ENTRELEC Terminal Block - Master Catalog](#)

English

[ZK2.5-S](#)

English

[SNK SERIES TERMINAL BLOCKS](#)

English

[ENTRELEC Terminal Blocks Catalogue \(RUS\)](#)

[Essential Entrelec Terminal Blocks](#)

French

[Essential Entrelec Terminal Blocks](#)

1SNK705310R0000

Modular Terminal Blocks, Disconnect, PI-Spring Terminal Block, Gray, Product
Spacing .205 in [5.2 mm], 2 Position, DIN Rail, ENTRELEC SNK



English

[Essential Entrelec Terminal Blocks](#)

Japanese

[Agency Approvals](#)

[BV_MARINE_34077_B3](#)

English