

1SNK705066R0000 ✓ ACTIVE

ENTRELEC | ENTRELEC SNK

TE Internal #: 1SNK705066R0000

Modular Terminal Blocks, Feed-Through, PI-Spring Terminal Block,
Black, Product Spacing .205 in [5.2 mm], 2 Position, DIN Rail,
ENTRELEC SNK

[View on TE.com >](#)



Connectors > Terminal Blocks & Strips > Modular Terminal Blocks



Block Function: **Feed-Through**

Modular Terminal Block Product Type: **PI-Spring Terminal Block**

Primary Product Color: **Black**

Product Spacing: **5.2 mm [.205 in]**

Number of Positions: **2**

Features

Product Type Features

Modular Terminal Block Product Type	PI-Spring Terminal Block
-------------------------------------	--------------------------

Configuration Features

Gauge Type	A2 / 2.3 mm Dia.
Number of Levels	1
Number of Circuits	1
Block Function	Feed-Through
Number of Positions	2

Electrical Characteristics

Impulse Withstanding Voltage Rating (IEC)	8000 V
Current Rating (CSA)	20 A
Power Loss	1 W
Short-Time Withstanding Current Rating @ 1s	300 A
Voltage Rating (IEC)	1000 V
Operating Voltage Rating (UL & CSA) (Max) - Main Circuit	600 V

Voltage Rating (CSA)	600 V
Dielectric Withstanding Voltage (Max)	2200 V
Current Rating (UL)	20 A
Current Rating (IEC)	24 A

Body Features

Product Weight	5.5 g[.217 oz]
Primary Product Color	Black

Mechanical Attachment

DIN Rail Mounting Type	TH35-15, TH35-7.5
Connector Mounting Type	DIN Rail

Housing Features

Housing Material	Polyamide
------------------	-----------

Dimensions

Main Circuit Capacity - 1 Rigid Stranded Conductor per Spring Clamp	.2 – 4 mm ²
Main Circuit Capacity - Twin Ferrule per Spring Clamp	.22 – .5 mm ²
Main Circuit Capacity - 1 Flexible Conductor per Spring Clamp	.22 – 2.5 mm ²
Wire Stripping Length	11 mm[.433 in]
Main Circuit Capacity - 1 Non-Insulated Ferrule per Spring Clamp	.22 – 2.5 mm ²
Main Circuit Capacity - 1 Insulated Ferrule per Spring Clamp	26 – 14 AWG
Tool Size	3.5 mm[.138 in]
Product Depth	40.2 mm
Product Length	40.2 mm
Product Height	50.9 mm
Product Spacing	5.2 mm[.205 in]

Usage Conditions

Installation Temperature Range	-5 – 40 °C[23 – 104 °F]
Operating Temperature Range	-55 – 110 °C[-67 – 230 °F]

Industry Standards

IP Rating	IP20
UL Flammability Rating	UL 94V-0



Product Compliance





[For compliance documentation, visit the product page on TE.com>](#)

EU RoHS Directive 2011/65/EU	Compliant
EU ELV Directive 2000/53/EC	Compliant
China RoHS 2 Directive MIIT Order No 32, 2016	No Restricted Materials Above Threshold
EU REACH Regulation (EC) No. 1907/2006	Current ECHA Candidate List: JUNE 2023 (235) Candidate List Declared Against: JUNE 2023 (235) Does not contain REACH SVHC
Halogen Content	Low Halogen - Br, Cl, F, I < 900 ppm per homogenous material. Also BFR/CFR/PVC Free
Solder Process Capability	Not reviewed for solder process capability

Product Compliance Disclaimer

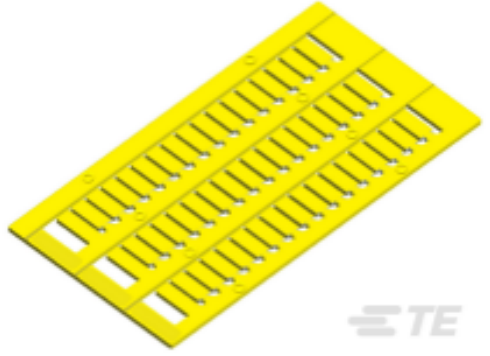
This information is provided based on reasonable inquiry of our suppliers and represents our current actual knowledge based on the information they provided. This information is subject to change. The part numbers that TE has identified as EU RoHS compliant have a maximum concentration of 0.1% by weight in homogenous materials for lead, hexavalent chromium, mercury, PBB, PBDE, DBP, BBP, DEHP, DIBP, and 0.01% for cadmium, or qualify for an exemption to these limits as defined in the Annexes of Directive 2011/65/EU (RoHS2). Finished electrical and electronic equipment products will be CE marked as required by Directive 2011/65/EU. Components may not be CE marked. Additionally, the part numbers that TE has identified as EU ELV compliant have a maximum concentration of 0.1% by weight in homogenous materials for lead, hexavalent chromium, and mercury, and 0.01% for cadmium, or qualify for an exemption to these limits as defined in the Annexes of Directive 2000/53/EC (ELV). Regarding the REACH Regulation, the information TE provides on SVHC in articles for this part number is based on the latest European Chemicals Agency (ECHA) 'Guidance on requirements for substances in articles' posted at this URL: <https://echa.europa.eu/guidance-documents/guidance-on-reach>

Compatible Parts

 <p>TE Part # 1SNK140004R0000 MC512-YL</p>	 <p>TE Part # 1SNK900001R0000 BAM4</p>	 <p>TE Part # 1SNK900002R0000 BAZ1</p>	 <p>TE Part # 1SNK900102R0000 BAZH1</p>
---	--	---	--



Also in the Series | **ENTRELEC SNK**

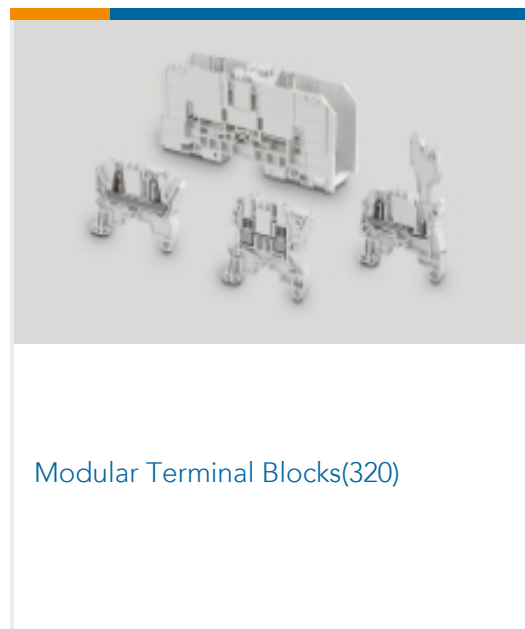

Customers Also Bought



TE Part #CX7198-000
RHW-16/4-1200/ADH-0



TE Part #5787170-7
68 50SR R/A RCPT ASSY,RDSN L/F



TE Part #749087-2
50SR SCREWLOCK KIT,FEMALE

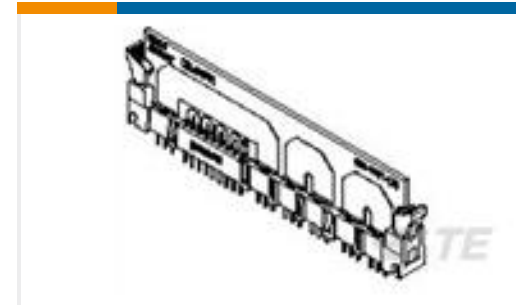

TE Part #1651826-1
283-0172-01303=CONN,SKT,CRNEDG



TE Part #1SNK900106R0000
CS-R2

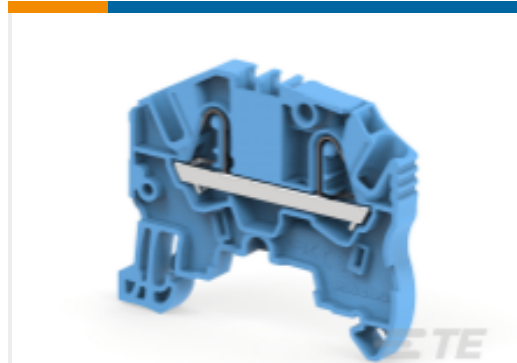

TE Part #1SNK705020R0000
ZK2.5-BL

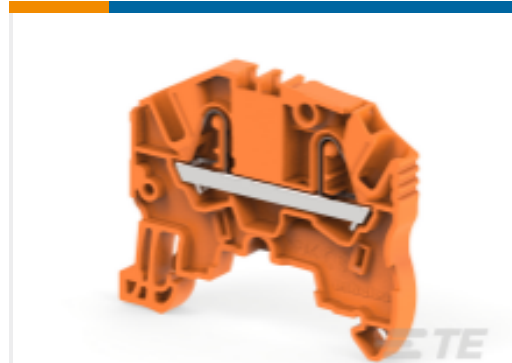

TE Part #1SNK705030R0000
ZK2.5-OR



TE Part #1SNK705910R0000
EK2.5

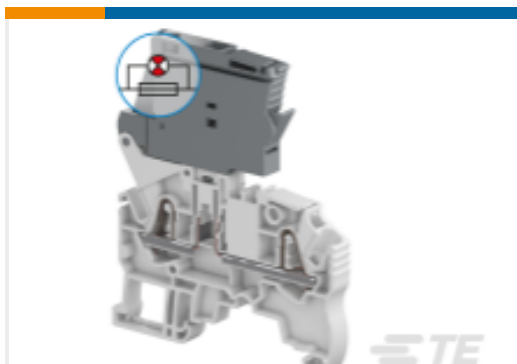

TE Part #1SNK706411R0000
ZK2.5-SF-R1

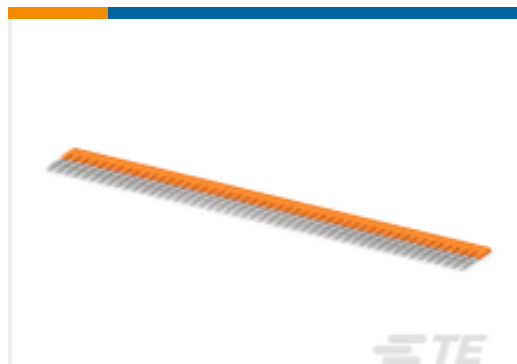

TE Part #1SNK905350R0000
JB5-50

Documents

CAD Files

3D PDF

3D

Customer View Model

[ENG_CVM_CVM_1SNK705066R0000_A.2d_dxf.zip](#)

English

Customer View Model

[ENG_CVM_CVM_1SNK705066R0000_A.3d_igs.zip](#)

English

Customer View Model

[ENG_CVM_CVM_1SNK705066R0000_A.3d_stp.zip](#)

English

By downloading the CAD file I accept and agree to the [Terms and Conditions](#) of use.

Datasheets & Catalog Pages

[ENTRELEC Terminal Block - Master Catalog](#)

[ENTRELEC Terminal Block - Master Catalog](#)

English



[ZK2.5-BK](#)

English

[SNK SERIES TERMINAL BLOCKS](#)

English

[ENTRELEC Terminal Blocks Catalogue \(RUS\)](#)

[Product Environmental Compliance](#)

[Product Compliance](#)

English

[Product Compliance](#)

English

[Agency Approvals](#)

[BV_MARINE_34077_B3](#)

English