

1SNK516151R0000 ✓ ACTIVE

ENTRELEC | ENTRELEC SNK

TE Internal #: 1SNK516151R0000

Modular Terminal Blocks, Ground, Screw Clamp Terminal Block, Green & Yellow, Product Spacing .63 in [16 mm], 2 Position, DIN Rail, ENTRELEC SNK

[View on TE.com >](#)



Connectors > Terminal Blocks & Strips > Modular Terminal Blocks



Block Function: **Ground**

Modular Terminal Block Product Type: **Screw Clamp Terminal Block**

Primary Product Color: **Green & Yellow**

Product Spacing: **16 mm [ .63 in ]**

Number of Positions: **2**

## Features

### Product Type Features

Modular Terminal Block Product Type	Screw Clamp Terminal Block
-------------------------------------	----------------------------

### Configuration Features

Gauge Type	Dia.11
Number of Levels	1
Number of Circuits	1
Block Function	Ground
Number of Positions	2

### Electrical Characteristics

Impulse Withstanding Voltage Rating (IEC)	8000 V
Dielectric Withstanding Voltage (Max)	2200 V
Short-Time Withstanding Current Rating @ 1s	6000 A

### Body Features

Product Weight	83 g[3.268 oz]
Primary Product Color	Green & Yellow

### Mechanical Attachment

DIN Rail Mounting Type	TH35-15, TH35-7.5
Connector Mounting Type	DIN Rail

### Housing Features

Housing Material	Polyamide
------------------	-----------

### Dimensions

Main Circuit Capacity - 1 Rigid Stranded Conductor per Screw Clamp	18 AWG
Main Circuit Capacity - Twin Ferrule per Screw Clamp	18 – 4 AWG
Main Circuit Capacity - 1 Flexible Conductor per Screw Clamp	1 – 50 mm <sup>2</sup>
Wire Stripping Length	17 mm[.669 in]
Main Circuit Capacity - 1 Insulated Ferrule per Screw Clamp	18 – 0 AWG
Main Circuit Capacity - 1 Non-Insulated Ferrule per Screw Clamp	1 – 50 mm <sup>2</sup>
Main Circuit Capacity - 2 Rigid Stranded Conductors per Screw Clamp	1 – 25 mm <sup>2</sup>
Main Circuit Capacity - 2 Flexible Conductors per Screw Clamp	1 – 25 mm <sup>2</sup>
Tool Size	6.5 mm[.256 in]
Product Depth	61.2 mm
Product Height	63.6 mm
Product Spacing	16 mm[.63 in]

### Usage Conditions

Installation Temperature Range	-5 – 40 °C[23 – 104 °F]
Operating Temperature Range	-55 – 110 °C[-67 – 230 °F]

### Industry Standards

UL Flammability Rating	UL 94V-0
------------------------	----------

### Product Compliance

[For compliance documentation, visit the product page on TE.com>](#)

EU RoHS Directive 2011/65/EU	Compliant
EU ELV Directive 2000/53/EC	Compliant
China RoHS 2 Directive MIIT Order No 32, 2016	No Restricted Materials Above Threshold
EU REACH Regulation (EC) No. 1907/2006	Current ECHA Candidate List: JUNE 2023 (235) Candidate List Declared Against: JUNE 2023 (235) Does not contain REACH SVHC
Halogen Content	Low Halogen - Br, Cl, F, I < 900 ppm per homogenous material. Also BFR/CFR/PVC

Free







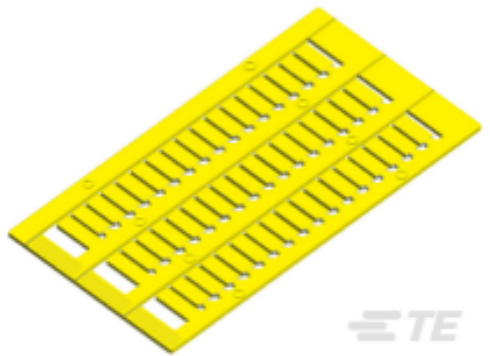
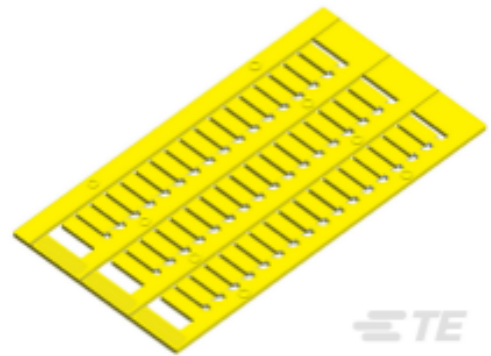
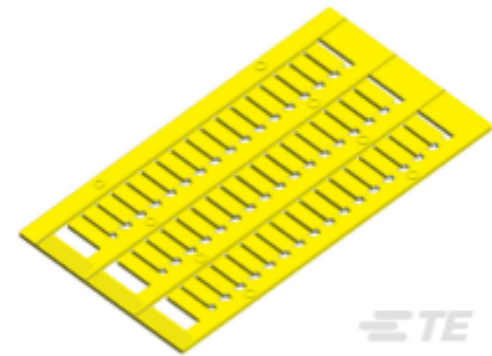

Solder Process Capability

Not reviewed for solder process capability

Product Compliance Disclaimer

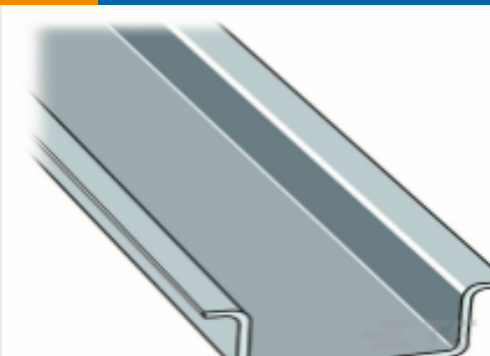
This information is provided based on reasonable inquiry of our suppliers and represents our current actual knowledge based on the information they provided. This information is subject to change. The part numbers that TE has identified as EU RoHS compliant have a maximum concentration of 0.1% by weight in homogenous materials for lead, hexavalent chromium, mercury, PBB, PBDE, DBP, BBP, DEHP, DIBP, and 0.01% for cadmium, or qualify for an exemption to these limits as defined in the Annexes of Directive 2011/65/EU (RoHS2). Finished electrical and electronic equipment products will be CE marked as required by Directive 2011/65/EU. Components may not be CE marked. Additionally, the part numbers that TE has identified as EU ELV compliant have a maximum concentration of 0.1% by weight in homogenous materials for lead, hexavalent chromium, and mercury, and 0.01% for cadmium, or qualify for an exemption to these limits as defined in the Annexes of Directive 2000/53/EC (ELV). Regarding the REACH Regulation, the information TE provides on SVHC in articles for this part number is based on the latest European Chemicals Agency (ECHA) 'Guidance on requirements for substances in articles' posted at this URL: <https://echa.europa.eu/guidance-documents/guidance-on-reach>

### Compatible Parts

 <p>TE Part # 1SNK140004R0000 MC512-YL</p>	 <p>TE Part # 1SNK150004R0000 MC612-YL</p>	 <p>TE Part # 1SNK160004R0000 MC812-YL</p>	 <p>TE Part # 1SNK900102R0000 BAZH1</p>
 <p>TE Part # 1SET111022R0000 WF250-16-BK</p>	 <p>TE Part # 1SET111024R0000 WF350-16-RD</p>	 <p>TE Part # 1SNA168500R1200 PR4</p>	 <p>TE Part # 1SNA168700R2200 PR5</p>
 <p>TE Part # 1SNA178529R0400 PR50</p>	 <p>TE Part # 1SNK140000R0000 MC512</p>	 <p>TE Part # 1SNK149999R0000 MC512PA</p>	 <p>TE Part # 1SNK150000R0000 MC612</p>



Also in the Series | **ENTRELEC SNK**

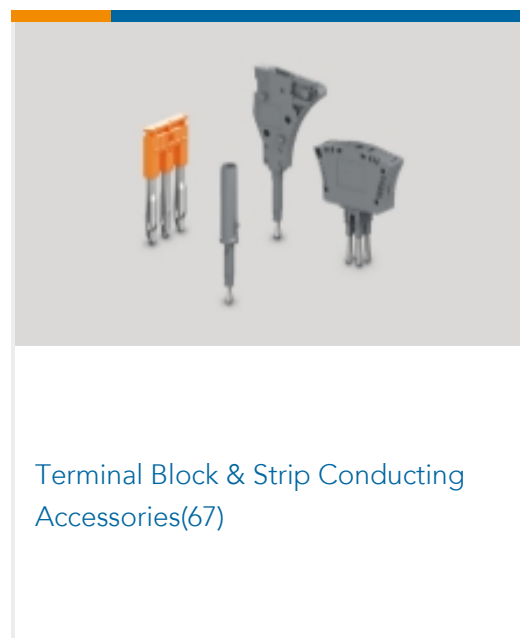

Customers Also Bought

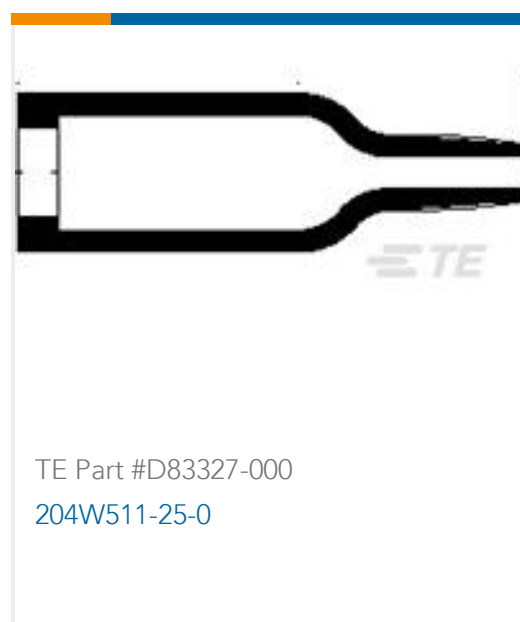



## Documents

### CAD Files

Customer View Model

[ENG\\_CVM\\_CVM\\_1SNK516151R0000\\_A1.3d\\_stp.zip](#)

English

Customer View Model

[ENG\\_CVM\\_CVM\\_1SNK516151R0000\\_A1.2d\\_dxf.zip](#)

English

Customer View Model

[ENG\\_CVM\\_CVM\\_1SNK516151R0000\\_A1.3d\\_igs.zip](#)

English

### 3D PDF

3D

By downloading the CAD file I accept and agree to the [Terms and Conditions](#) of use.

### Datasheets & Catalog Pages

[ENTRELEC Terminal Block - Master Catalog](#)

[ENTRELEC Terminal Block - Master Catalog](#)

English

[ZS50-PE](#)

English

[SNK SERIES TERMINAL BLOCKS](#)

English

[ENTRELEC Terminal Blocks Catalogue \(RUS\)](#)

[Essential Entrelec Terminal Blocks](#)

French

[Essential Entrelec Terminal Blocks](#)

English

[Essential Entrelec Terminal Blocks](#)

Japanese

### Product Environmental Compliance

[Product Compliance](#)

English

[Product Compliance](#)

English

### Agency Approvals

[ZK-ZS\\_ATEX\\_1SND225112U1006-C-TE](#)

English