

1SNK508065R0000 ✓ ACTIVE

ENTRELEC | ENTRELEC SNK

TE Internal #: 1SNK508065R0000

Modular Terminal Blocks, Feed-Through, Screw Clamp Terminal Block, White, Product Spacing .315 in [8 mm], 2 Position, DIN Rail, ENTRELEC SNK

[View on TE.com >](#)



Connectors > Terminal Blocks & Strips > Modular Terminal Blocks



Block Function: **Feed-Through**

Modular Terminal Block Product Type: **Screw Clamp Terminal Block**

Primary Product Color: **White**

Product Spacing: **8 mm [.315 in]**

Number of Positions: **2**

Features

Product Type Features

Modular Terminal Block Product Type	Screw Clamp Terminal Block
-------------------------------------	----------------------------

Configuration Features

Gauge Type	A5-B5
Number of Levels	1
Number of Circuits	1
Block Function	Feed-Through
Number of Positions	2

Electrical Characteristics

Impulse Withstanding Voltage Rating (IEC)	8000 V
Current Rating (CSA)	42 A
Power Loss	1.8 W
Short-Time Withstanding Current Rating @ 1s	1200 A
Voltage Rating (IEC)	1000 V
Operating Voltage Rating (UL & CSA) (Max) - Main Circuit	600 V

Voltage Rating (CSA)	600 V
Dielectric Withstanding Voltage (Max)	2200 V
Current Rating (UL)	42 A
Current Rating (IEC)	57 A

Body Features

Product Weight	14.1 g [.555 oz]
Primary Product Color	White

Mechanical Attachment

DIN Rail Mounting Type	TH35-15, TH35-7.5
Connector Mounting Type	DIN Rail

Housing Features

Housing Material	Polyamide
------------------	-----------

Dimensions

Main Circuit Capacity - Twin Ferrule per Screw Clamp	20 – 12 AWG
Main Circuit Capacity - 1 Flexible Conductor per Screw Clamp	24 – 6 AWG
Main Circuit Capacity - 1 Insulated Ferrule per Screw Clamp	24 – 10 AWG
Main Circuit Capacity - 1 Non-Insulated Ferrule per Screw Clamp	.5 – 10 mm ²
Main Circuit Capacity - 2 Flexible Conductors per Screw Clamp	.5 – 4 mm ²
Main Circuit Capacity - 1 Rigid Stranded Conductor per Screw Clamp	24 – 6 AWG
Wire Stripping Length	12 mm [.472 in]
Main Circuit Capacity - 2 Rigid Stranded Conductors per Screw Clamp	.5 – 4 mm ²
Tool Size	4 mm [.157 in]
Product Depth	47.3 mm
Product Length	47.3 mm [1.86 in]
Product Height	53 mm
Product Spacing	8 mm [.315 in]

Usage Conditions

Installation Temperature Range	-5 – 40 °C [23 – 104 °F]
Operating Temperature Range	-55 – 110 °C [-67 – 230 °F]

Industry Standards

IP Rating	IP20
-----------	------



UL Flammability Rating

UL 94V-0

Product Compliance



[For compliance documentation, visit the product page on TE.com>](#)

EU RoHS Directive 2011/65/EU	Compliant
EU ELV Directive 2000/53/EC	Compliant
China RoHS 2 Directive MIIT Order No 32, 2016	No Restricted Materials Above Threshold
EU REACH Regulation (EC) No. 1907/2006	Current ECHA Candidate List: JUNE 2023 (235) Candidate List Declared Against: JUNE 2023 (235) Does not contain REACH SVHC
Halogen Content	Low Halogen - Br, Cl, F, I < 900 ppm per homogenous material. Also BFR/CFR/PVC Free
Solder Process Capability	Not reviewed for solder process capability

Product Compliance Disclaimer

This information is provided based on reasonable inquiry of our suppliers and represents our current actual knowledge based on the information they provided. This information is subject to change. The part numbers that TE has identified as EU RoHS compliant have a maximum concentration of 0.1% by weight in homogenous materials for lead, hexavalent chromium, mercury, PBB, PBDE, DBP, BBP, DEHP, DIBP, and 0.01% for cadmium, or qualify for an exemption to these limits as defined in the Annexes of Directive 2011/65/EU (RoHS2). Finished electrical and electronic equipment products will be CE marked as required by Directive 2011/65/EU. Components may not be CE marked. Additionally, the part numbers that TE has identified as EU ELV compliant have a maximum concentration of 0.1% by weight in homogenous materials for lead, hexavalent chromium, and mercury, and 0.01% for cadmium, or qualify for an exemption to these limits as defined in the Annexes of Directive 2000/53/EC (ELV). Regarding the REACH Regulation, the information TE provides on SVHC in articles for this part number is based on the latest European Chemicals Agency (ECHA) 'Guidance on requirements for substances in articles' posted at this URL: <https://echa.europa.eu/guidance-documents/guidance-on-reach>

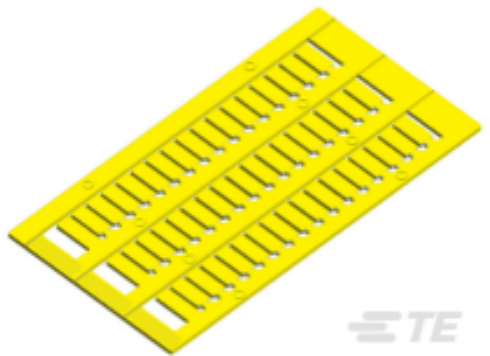
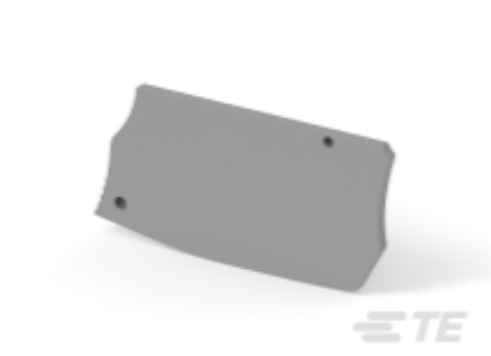
Compatible Parts

 <p>TE Part # 1SNK160004R0000 MC812-YL</p>	 <p>TE Part # 1SNK505910R0000 ES4</p>	 <p>TE Part # 1SNK900001R0000 BAM4</p>	 <p>TE Part # 1SNK900002R0000 BAZ1</p>
---	---	---	---

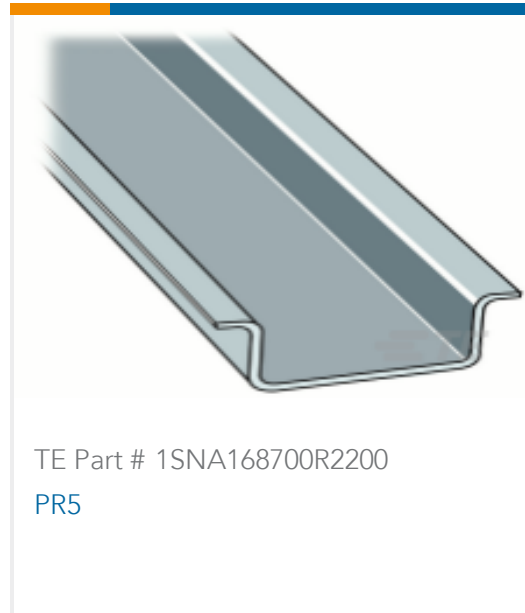

Also in the Series | **ENTRELEC SNK**

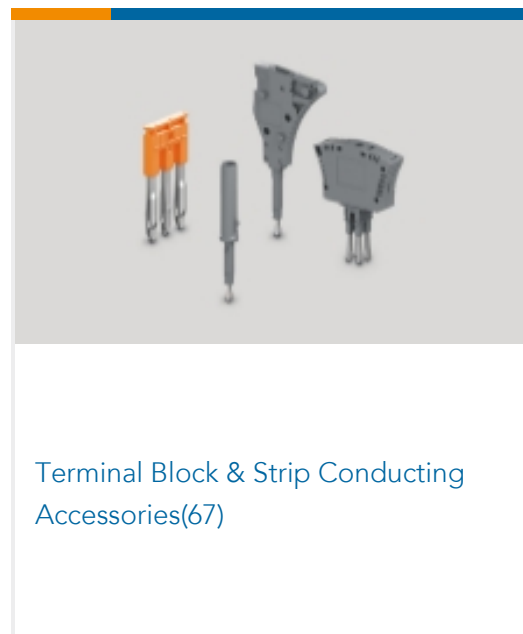
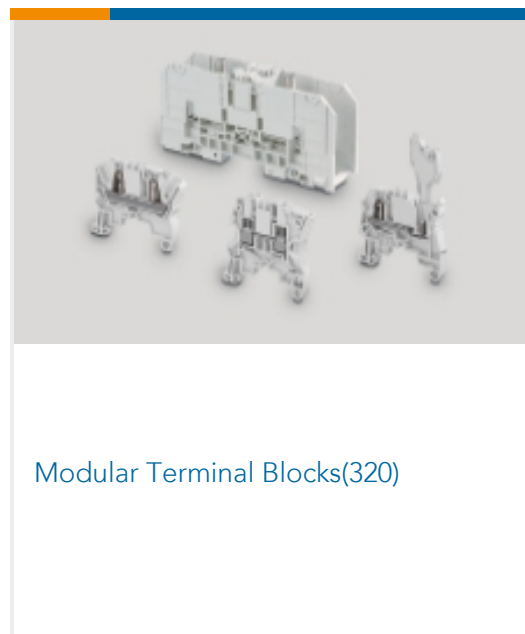

Customers Also Bought



TE Part #206061-1
Cable/Panel Mount Connector, CPC
Series 1



TE Part #1-66360-2
Pin and Socket Contacts, Type III, LP



TE Part #1SNK505910R0000
ES4



TE Part #58433-3
PRO CR ASSY, RBY IS9252



TE Part #1SNK505030R0000
ZS4-OR



TE Part #1SNK506150R0000
ZS6-PE



TE Part #1SNK905310R0000
JB5-10



TE Part #1SNK908302R0000
JB8-2

Documents

CAD Files

Customer View Model

[ENG_CVM_CVM_1SNK508065R0000_A1.3d_igs.zip](#)

English

Customer View Model

[ENG_CVM_CVM_1SNK508065R0000_A1.3d_stp.zip](#)

English

Customer View Model

[ENG_CVM_CVM_1SNK508065R0000_A1.2d_dxf.zip](#)

English

3D PDF

3D

By downloading the CAD file I accept and agree to the [Terms and Conditions](#) of use.

Datasheets & Catalog Pages

[ENTRELEC Terminal Block - Master Catalog](#)

[ENTRELEC Terminal Block - Master Catalog](#)

English

[ZS10-WH](#)

English

[SNK SERIES TERMINAL BLOCKS](#)

English

[ENTRELEC Terminal Blocks Catalogue \(RUS\)](#)

Agency Approvals

[ZK-ZS_ATEX_1SND225112U1006-C-TE](#)

1SNK508065R0000

Modular Terminal Blocks, Feed-Through, Screw Clamp Terminal Block, White,
Product Spacing .315 in [8 mm], 2 Position, DIN Rail, ENTRELEC SNK



English