

1SNK506415R0000 ✓ ACTIVE

ENTRELEC | ENTRELEC SNK

TE Internal #: 1SNK506415R0000

Modular Terminal Blocks, Fuse, Screw Clamp Terminal Block, Gray & Dark Gray, Product Spacing .236 in [6 mm], 2 Position, DIN Rail, ENTRELEC SNK

[View on TE.com >](#)



Connectors > Terminal Blocks & Strips > Modular Terminal Blocks

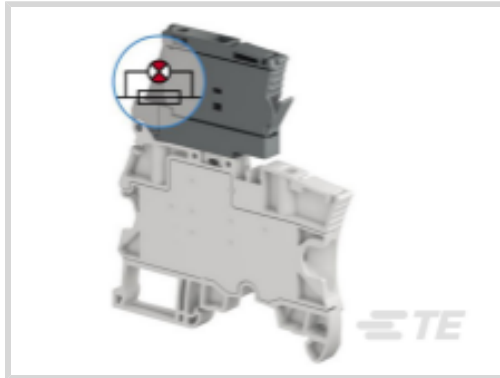

Block Function: **Fuse**

Modular Terminal Block Product Type: **Screw Clamp Terminal Block**

Primary Product Color: **Gray & Dark Gray**

Product Spacing: **6 mm [.236 in]**

Number of Positions: **2**

Features

Product Type Features

Modular Terminal Block Product Type	Screw Clamp Terminal Block
-------------------------------------	----------------------------

Configuration Features

Gauge Type	A3-B3
Number of Levels	1
Number of Circuits	1
Block Function	Fuse
Number of Positions	2

Electrical Characteristics

Impulse Withstanding Voltage Rating (IEC)	6000 V
Current Rating (CSA)	6.3 A
Voltage Rating (IEC)	500 V
Operating Voltage Rating (UL & CSA) (Max) - Main Circuit	150 V
Voltage Rating (CSA)	150 V
Dielectric Withstanding Voltage (Max)	1890 V
Current Rating (UL)	10 A
Current Rating (IEC)	6.3 A

Body Features

Product Weight	18.6 g[.732 oz]
----------------	-----------------

Primary Product Color	Gray & Dark Gray
-----------------------	------------------

Mechanical Attachment

DIN Rail Mounting Type	TH35-15, TH35-7.5
------------------------	-------------------

Connector Mounting Type	DIN Rail
-------------------------	----------

Housing Features

Housing Material	Polyamide
------------------	-----------

Dimensions

Main Circuit Capacity - Twin Ferrule per Screw Clamp	24 – 16 AWG
--	-------------

Main Circuit Capacity - 1 Flexible Conductor per Screw Clamp	24 – 10 AWG
--	-------------

Main Circuit Capacity - 1 Insulated Ferrule per Screw Clamp	24 – 12 AWG
---	-------------

Main Circuit Capacity - 1 Non-Insulated Ferrule per Screw Clamp	.22 – 4 mm ²
---	-------------------------

Main Circuit Capacity - 2 Flexible Conductors per Screw Clamp	.2 – 1.5 mm ²
---	--------------------------

Main Circuit Capacity - 1 Rigid Stranded Conductor per Screw Clamp	24 – 10 AWG
--	-------------

Wire Stripping Length	10.5 mm[.413 in]
-----------------------	------------------

Main Circuit Capacity - 2 Rigid Stranded Conductors per Screw Clamp	.2 – 1.5 mm ²
---	--------------------------

Tool Size	3.5 mm[.138 in]
-----------	-----------------

Product Depth	76.8 mm
---------------	---------

Product Length	76.8 mm[3.02 in]
----------------	------------------

Product Height	70.5 mm
----------------	---------

Product Spacing	6 mm[.236 in]
-----------------	---------------

Usage Conditions

Installation Temperature Range	-5 – 40 °C[23 – 104 °F]
--------------------------------	-------------------------

Operating Temperature Range	-55 – 110 °C[-67 – 230 °F]
-----------------------------	----------------------------

Industry Standards

IP Rating	IP20
-----------	------

UL Flammability Rating	UL 94V-0
------------------------	----------

Product Compliance

[For compliance documentation, visit the product page on TE.com>](#)

EU RoHS Directive 2011/65/EU	Compliant
------------------------------	-----------

EU ELV Directive 2000/53/EC

Compliant

China RoHS 2 Directive MIIT Order No 32, 2016

No Restricted Materials Above Threshold

EU REACH Regulation (EC) No. 1907/2006

Current ECHA Candidate List: JUNE 2023 (235)

Candidate List Declared Against: JUNE 2022 (224)

Does not contain REACH SVHC

Halogen Content

Low Halogen - Br, Cl, F, I < 900 ppm per homogenous material. Also BFR/CFR/PVC Free

Solder Process Capability

Not reviewed for solder process capability

Product Compliance Disclaimer

This information is provided based on reasonable inquiry of our suppliers and represents our current actual knowledge based on the information they provided. This information is subject to change. The part numbers that TE has identified as EU RoHS compliant have a maximum concentration of 0.1% by weight in homogenous materials for lead, hexavalent chromium, mercury, PBB, PBDE, DBP, BBP, DEHP, DIBP, and 0.01% for cadmium, or qualify for an exemption to these limits as defined in the Annexes of Directive 2011/65/EU (RoHS2). Finished electrical and electronic equipment products will be CE marked as required by Directive 2011/65/EU. Components may not be CE marked. Additionally, the part numbers that TE has identified as EU ELV compliant have a maximum concentration of 0.1% by weight in homogenous materials for lead, hexavalent chromium, and mercury, and 0.01% for cadmium, or qualify for an exemption to these limits as defined in the Annexes of Directive 2000/53/EC (ELV). Regarding the REACH Regulation, the information TE provides on SVHC in articles for this part number is based on the latest European Chemicals Agency (ECHA) 'Guidance on requirements for substances in articles' posted at this URL: <https://echa.europa.eu/guidance-documents/guidance-on-reach>

Compatible Parts

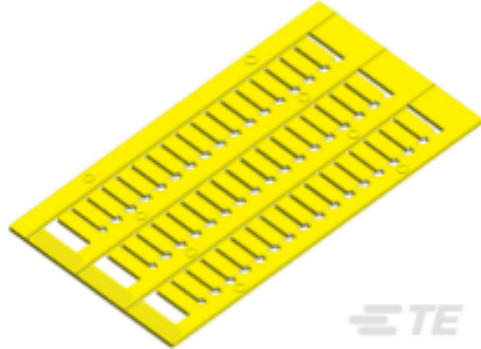

TE Part # 1SNK150004R0000
MC612-YL



TE Part # 1SNK900001R0000
BAM4



TE Part # 1SNK900002R0000
BAZ1



TE Part # 1SNK900105R0000
ES-TC6



TE Part # 1SNK900203R0000
TP2



TE Part # 1SNK906305R0000
JB6-5



TE Part # 1SNA113546R1400
PC6-2



TE Part # 1SNA113548R2600
PC6-10



Also in the Series | **ENTRELEC SNK**



Customers Also Bought





Documents

CAD Files

3D PDF

3D

Customer View Model

[ENG_CVM_CVM_1SNK506415R0000_A.2d_dxf.zip](#)

English

Customer View Model

[ENG_CVM_CVM_1SNK506415R0000_A.3d_igs.zip](#)

English

Customer View Model

[ENG_CVM_CVM_1SNK506415R0000_A.3d_stp.zip](#)

English

By downloading the CAD file I accept and agree to the [Terms and Conditions](#) of use.

Datasheets & Catalog Pages

[ENTRELEC Terminal Block - Master Catalog](#)

[ENTRELEC Terminal Block - Master Catalog](#)

English

[ZS4-SF-R3](#)

English

[SNK SERIES TERMINAL BLOCKS](#)

English

[ENTRELEC Terminal Blocks Catalogue \(RUS\)](#)