

1SNK160131R0000 ✓ ACTIVE

ENTRELEC

TE Internal #: 1SNK160131R0000

Terminal Block & Strip Marking Accessories, Marker Card, 121 ->
130 (x10) Mark Details, White, Horizontal, -55 – 110 °C [-67 – 230 °F],
UL 94V-2

[View on TE.com >](#)



Connectors > Terminal Blocks & Strips > Terminal Block & Strip Accessories > Terminal Block & Strip Marking Accessories



Marking Product Type: **Marker Card**

Pre-Printed Mark Details: **121 -> 130 (x10)**

Primary Product Color: **White**

Product Orientation: **Horizontal**

Operating Temperature Range: **-55 – 110 °C [-67 – 230 °F]**

Features

Product Type Features

Marking Product Type	Marker Card
----------------------	-------------

Configuration Features

Number of Cards per Package	1
Number of Digits per Marker - Horizontal	4
Number of Digits per Marker - Vertical	8
Pre-Printed Mark Details	121 -> 130 (x10)

Body Features

Product Weight	14 g[.494 oz]
Primary Product Material	Polyamide
Primary Product Color	White
Product Orientation	Horizontal

Dimensions

Product Depth	7.6 mm
Product Width	8 mm[.315 in]
Product Length	7.6 mm[.299 in]
Product Height	12 mm[.472 in]

Usage Conditions

Operating Temperature Range	-55 – 110 °C[-67 – 230 °F]
-----------------------------	----------------------------

Industry Standards

UL Flammability Rating	UL 94V-2
------------------------	----------

Product Compliance

[For compliance documentation, visit the product page on TE.com>](#)

EU RoHS Directive 2011/65/EU	Compliant
EU ELV Directive 2000/53/EC	Compliant
China RoHS 2 Directive MIIT Order No 32, 2016	No Restricted Materials Above Threshold
EU REACH Regulation (EC) No. 1907/2006	Current ECHA Candidate List: JUNE 2023 (235) Candidate List Declared Against: JUNE 2023 (235) Does not contain REACH SVHC
Halogen Content	Low Halogen - Br, Cl, F, I < 900 ppm per homogenous material. Also BFR/CFR/PVC Free
Solder Process Capability	Not reviewed for solder process capability

Product Compliance Disclaimer

This information is provided based on reasonable inquiry of our suppliers and represents our current actual knowledge based on the information they provided. This information is subject to change. The part numbers that TE has identified as EU RoHS compliant have a maximum concentration of 0.1% by weight in homogenous materials for lead, hexavalent chromium, mercury, PBB, PBDE, DBP, BBP, DEHP, DIBP, and 0.01% for cadmium, or qualify for an exemption to these limits as defined in the Annexes of Directive 2011/65/EU (RoHS2). Finished electrical and electronic equipment products will be CE marked as required by Directive 2011/65/EU. Components may not be CE marked. Additionally, the part numbers that TE has identified as EU ELV compliant have a maximum concentration of 0.1% by weight in homogenous materials for lead, hexavalent chromium, and mercury, and 0.01% for cadmium, or qualify for an exemption to these limits as defined in the Annexes of Directive 2000/53/EC (ELV). Regarding the REACH Regulation, the information TE provides on SVHC in articles for this part number is based on the latest European Chemicals Agency (ECHA) 'Guidance on requirements for substances in articles' posted at this URL: <https://echa.europa.eu/guidance-documents/guidance-on-reach>

Compatible Parts



Customers Also Bought

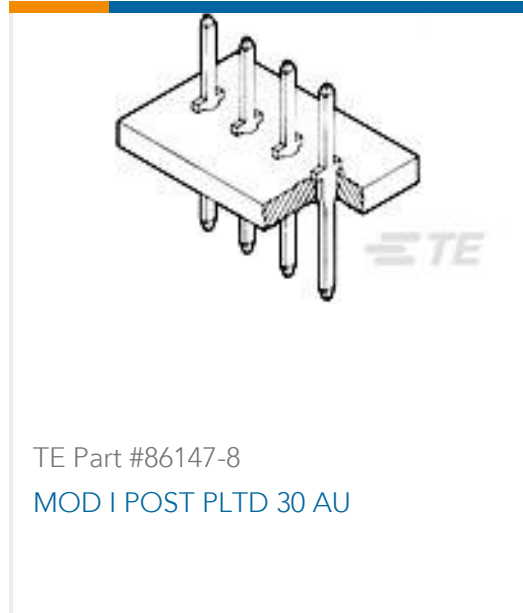

Documents

CAD Files

3D PDF

3D

Customer View Model

[ENG_CVM_CVM_1SNK160131R0000_A.2d_dxf.zip](#)

English

Customer View Model

[ENG_CVM_CVM_1SNK160131R0000_A.3d_igs.zip](#)

English

Customer View Model

[ENG_CVM_CVM_1SNK160131R0000_A.3d_stp.zip](#)

English

By downloading the CAD file I accept and agree to the [Terms and Conditions](#) of use.

Datasheets & Catalog Pages

[ENTRELEC Terminal Block - Master Catalog](#)

[ENTRELEC Terminal Block - Master Catalog](#)

English

1SNK160131R0000

Terminal Block & Strip Marking Accessories, Marker Card, 121 -> 130 (x10) Mark
Details, White, Horizontal, -55 – 110 °C [-67 – 230 °F], UL 94V-2



[MC812PA 121->130 \(x10\) Horizon](#)

English

[SNK SERIES TERMINAL BLOCKS](#)

English

[ENTRELEC Terminal Blocks Catalogue \(RUS\)](#)