



**Power Double Lock**

TE Internal #: 1971598-1

Rectangular Power Connectors, Housing, Plug, Wire-to-Wire, 8 Position, 3.96 mm [.156 in] Centerline, Wire & Cable, UL 94V-0, Power Double Lock

[View on TE.com >](#)

Connectors > Power Connectors > Rectangular Power > Rectangular Power Connectors > Glow Wire Power Double Lock Plug

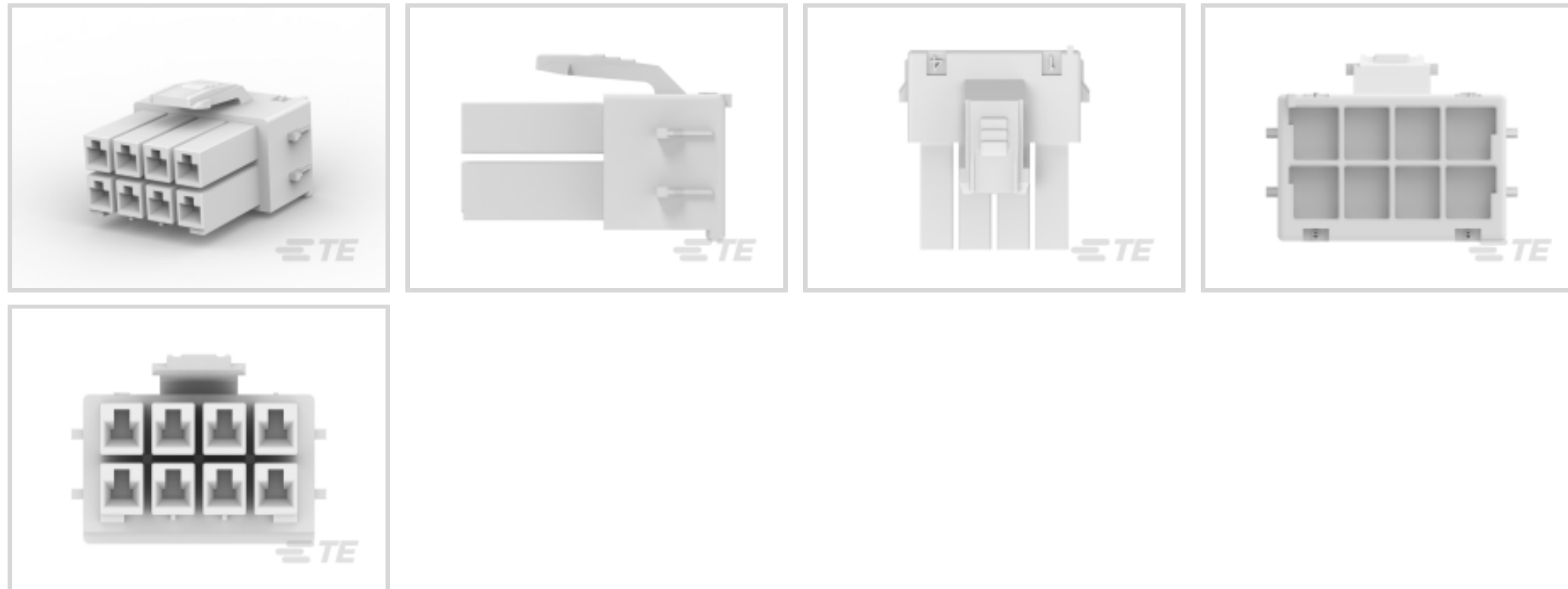

Rectangular Power Connector Type: **Housing**

Connector & Housing Type: **Plug**

Connector System: **Wire-to-Wire**

Number of Positions: **8**

Centerline (Pitch): **3.96 mm [.156 in]**

[All Glow Wire Power Double Lock Plug \(55\)](#)

**Features**

**Product Type Features**

Compatible With Discrete Wire Type	Stranded
Rectangular Power Connector Type	Housing
Connector & Housing Type	Plug
Connector System	Wire-to-Wire
Sealable	No
Connector & Contact Terminates To	Wire & Cable

**Configuration Features**

Number of Positions	8
Number of Rows	2

**Electrical Characteristics**

Operating Voltage	300 VAC
-------------------	---------

**Contact Features**

--	--



Contact Layout	Matrix
Contact Retention Within Housing	Without
Contact Type	Receptacle

#### Termination Features

Termination Method to Wire & Cable	Crimp
------------------------------------	-------

#### Mechanical Attachment

Connector Mounting Type	Cable Mount (Free-Hanging)
-------------------------	----------------------------

#### Housing Features

Centerline (Pitch)	3.96 mm [.156 in]
Housing Color	Natural
Housing Material	PA 66

#### Dimensions

Row-to-Row Spacing	4.6 mm [.181 in]
--------------------	------------------

#### Usage Conditions

Operating Temperature Range	-30 – 105 °C [-22 – 221 °F]
-----------------------------	-----------------------------

#### Operation/Application

Circuit Application	Power & Signal
---------------------	----------------

#### Industry Standards

Agency/Standard	CNR, USR
Approved Standards	CSA/C22.2 No. 182.3-M1987, UL 1977
UL Flammability Rating	UL 94V-0
Glow Wire Rating	GWT 750°C (Without Flame)

#### Packaging Features

Packaging Quantity	500
Packaging Method	Bag

#### Product Compliance

[For compliance documentation, visit the product page on TE.com>](#)

EU RoHS Directive 2011/65/EU	Compliant
EU ELV Directive 2000/53/EC	Compliant
China RoHS 2 Directive MIIT Order No 32, 2016	No Restricted Materials Above Threshold
EU REACH Regulation (EC) No. 1907/2006	



Current ECHA Candidate List: JUNE 2023 (235)  
 Candidate List Declared Against: JUNE 2023 (235)  
 Does not contain REACH SVHC

Halogen Content Not Low Halogen - contains Br or Cl > 900 ppm.

Solder Process Capability Not applicable for solder process capability

Product Compliance Disclaimer

This information is provided based on reasonable inquiry of our suppliers and represents our current actual knowledge based on the information they provided. This information is subject to change. The part numbers that TE has identified as EU RoHS compliant have a maximum concentration of 0.1% by weight in homogenous materials for lead, hexavalent chromium, mercury, PBB, PBDE, DBP, BBP, DEHP, DIBP, and 0.01% for cadmium, or qualify for an exemption to these limits as defined in the Annexes of Directive 2011/65/EU (RoHS2). Finished electrical and electronic equipment products will be CE marked as required by Directive 2011/65/EU. Components may not be CE marked. Additionally, the part numbers that TE has identified as EU ELV compliant have a maximum concentration of 0.1% by weight in homogenous materials for lead, hexavalent chromium, and mercury, and 0.01% for cadmium, or qualify for an exemption to these limits as defined in the Annexes of Directive 2000/53/EC (ELV). Regarding the REACH Regulation, the information TE provides on SVHC in articles for this part number is based on the latest European Chemicals Agency (ECHA) 'Guidance on requirements for substances in articles' posted at this URL: <https://echa.europa.eu/guidance-documents/guidance-on-reach>

## Compatible Parts

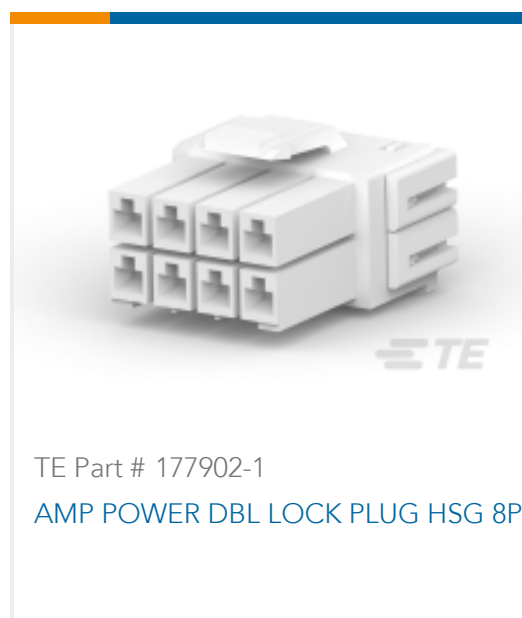

## Also in the Series | Power Double Lock

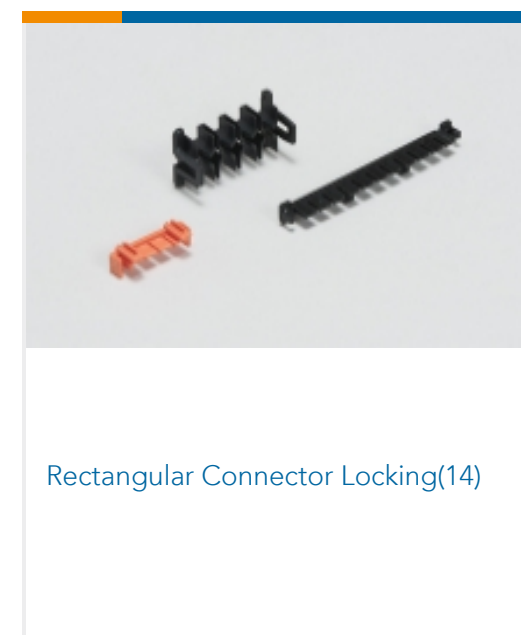
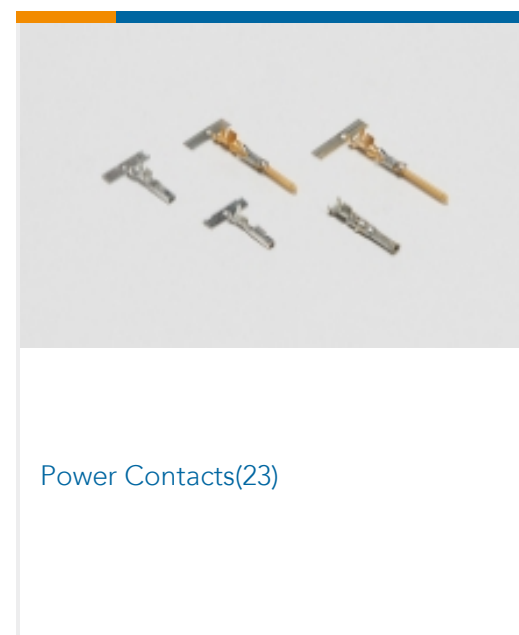
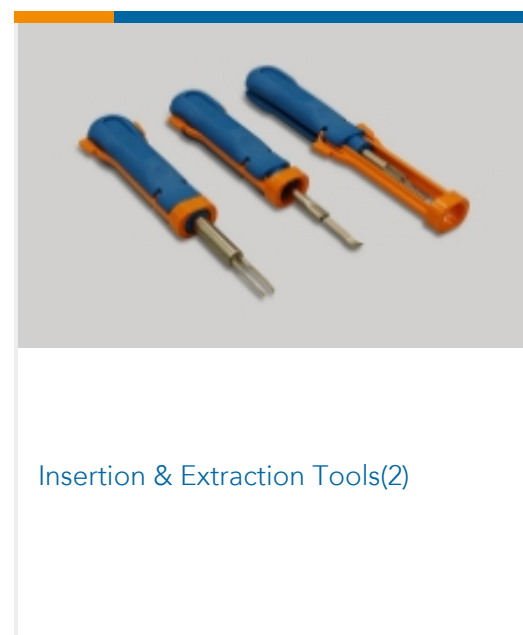
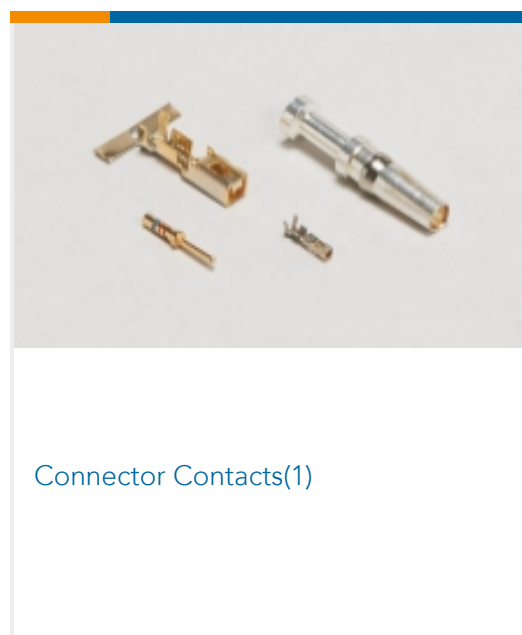



Rectangular Power Connectors(284)

## Customers Also Bought



TE Part #1971786-1  
PTL TAB CONTACT, 20 - 24 AWG



TE Part #2005253-1  
PDL 6P CAP 3.96 D/R F/H(GWT) N



TE Part #880688-1  
FF 250 TERMINAL 0.5-1.0MM2 0.39 X13.2 BR

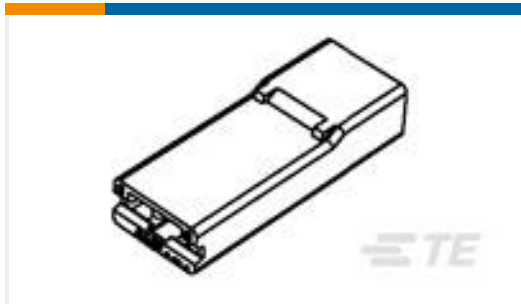

TE Part #8-735075-0  
250 FASTON HSG. REC. 1P NATURAL



TE Part #4-280050-1  
250 FASTON, FLAG, REC., 16-20 AWG, BR



TE Part #1-2133346-0  
250 FASTON HSG., REC., 1 POS, NATURAL



TE Part #1-881623-1  
FASTON 187 REC 0.5-1.0MM2 0.32X13.97 BR



TE Part #2-2133346-0  
250 FASTON HSG., REC., 1 POS, BLACK



TE Part #626279-2  
RING TONGUE 0.5-1.50 MM2 TPBR

## Documents

### Product Drawings

[POWER DBL LOCK PLUG HSG 8P\(GWT\)](#)

English

### CAD Files

[3D PDF](#)

[3D](#)

### Customer View Model

[ENG\\_CVM\\_CVM\\_1971598-1\\_B.2d\\_dxf.zip](#)



English

**Customer View Model**

[ENG\\_CVM\\_CVM\\_1971598-1\\_B.3d\\_igs.zip](#)

English

**Customer View Model**

[ENG\\_CVM\\_CVM\\_1971598-1\\_B.3d\\_stp.zip](#)

English

By downloading the CAD file I accept and agree to the [Terms and Conditions](#) of use.

---

**Product Specifications**

[Application Specification](#)

English

---

**Product Environmental Compliance**

[Product Compliance](#)

English

[Product Compliance](#)

English

---

**Instruction Sheets**

[Instruction Sheet \(non U.S.\)](#)

English

[AMP POWER DOUBLELOCK CONNECTOR SERIES](#)

English

---

**Agency Approvals**

[Agency Approval Document](#)

English