

1903977-1 ✓ ACTIVE

Z-PACK | Z-PACK 2mm HM

TE Internal #: 1903977-1

Rectangular Power Connectors, Header, Plug, Board-to-Board, 4 Position, 3 mm [.118 in] Centerline, Printed Circuit Board, UL 94V-0, Z-PACK 2mm HM

[View on TE.com >](#)



Connectors > Power Connectors > Rectangular Power > Rectangular Power Connectors



Rectangular Power Connector Type: **Header**

Connector & Housing Type: **Plug**

Connector System: **Board-to-Board**

Number of Positions: **4**

Centerline (Pitch): **3 mm [.118 in]**

## Features

### Product Type Features

Header Type	Fully Shrouded
Rectangular Power Connector Type	Header
Connector & Housing Type	Plug
Connector System	Board-to-Board
Sealable	No
Connector & Contact Terminates To	Printed Circuit Board

### Configuration Features

Number of Positions	4
PCB Mount Orientation	Right Angle
Number of Power Positions	4
Number of Signal Positions	0
Number of Rows	1

### Electrical Characteristics

Operating Voltage	48 VDC
-------------------	--------

### Contact Features

Contact Mating Area Plating Material	Gold
Contact Underplating Material	Nickel
Contact Base Material	Copper Alloy



Contact Current Rating (Max)	8 A
Contact Retention Within Housing	With
Contact Type	Blade
PCB Contact Termination Area Plating Material	Tin
Contact Mating Area Plating Material Thickness	.76 $\mu\text{m}$ [30 $\mu\text{in}$ ]

### Termination Features

Termination Method to Printed Circuit Board	Through Hole - Press-Fit
---	--------------------------

### Mechanical Attachment

Connector Mounting Type	Board Mount
-------------------------	-------------

### Housing Features

Centerline (Pitch)	3 mm[.118 in]
Housing Color	Natural
Housing Material	Thermoplastic

### Usage Conditions

Operating Temperature Range	-55 – 125 $^{\circ}\text{C}$ [-67 – 257 $^{\circ}\text{F}$ ]
-----------------------------	--

### Operation/Application

Circuit Application	Power
---------------------	-------

### Industry Standards

UL Flammability Rating	UL 94V-0
Glow Wire Rating	Standard Part - Not Glow Wire

### Packaging Features

Packaging Method	Box & Tube, Tube
------------------	------------------

## Product Compliance

[For compliance documentation, visit the product page on TE.com>](#)

EU RoHS Directive 2011/65/EU	Compliant
EU ELV Directive 2000/53/EC	Compliant
China RoHS 2 Directive MIIT Order No 32, 2016	No Restricted Materials Above Threshold
EU REACH Regulation (EC) No. 1907/2006	Current ECHA Candidate List: JUNE 2023 (235) Candidate List Declared Against: JUNE 2023 (235) Does not contain REACH SVHC



Halogen Content	Not Low Halogen - contains Br or Cl > 900 ppm.
-----------------	--

Solder Process Capability	Not applicable for solder process capability
---------------------------	--

**Product Compliance Disclaimer**

This information is provided based on reasonable inquiry of our suppliers and represents our current actual knowledge based on the information they provided. This information is subject to change. The part numbers that TE has identified as EU RoHS compliant have a maximum concentration of 0.1% by weight in homogenous materials for lead, hexavalent chromium, mercury, PBB, PBDE, DBP, BBP, DEHP, DIBP, and 0.01% for cadmium, or qualify for an exemption to these limits as defined in the Annexes of Directive 2011/65/EU (RoHS2). Finished electrical and electronic equipment products will be CE marked as required by Directive 2011/65/EU. Components may not be CE marked. Additionally, the part numbers that TE has identified as EU ELV compliant have a maximum concentration of 0.1% by weight in homogenous materials for lead, hexavalent chromium, and mercury, and 0.01% for cadmium, or qualify for an exemption to these limits as defined in the Annexes of Directive 2000/53/EC (ELV). Regarding the REACH Regulation, the information TE provides on SVHC in articles for this part number is based on the latest European Chemicals Agency (ECHA) 'Guidance on requirements for substances in articles' posted at this URL: <https://echa.europa.eu/guidance-documents/guidance-on-reach>

## Compatible Parts



TE Part # 2-1903978-1  
POWER MODULE 4POS.REC. ASSY,



TE Part # 1903978-1  
POWER MODULE 4POS. REC. ASSY,



TE Part # 2-1903977-2  
SLIM UPM 4POS. R/A HDR ASSEMBLY, SnPb

## Also in the Series | Z-PACK 2mm HM

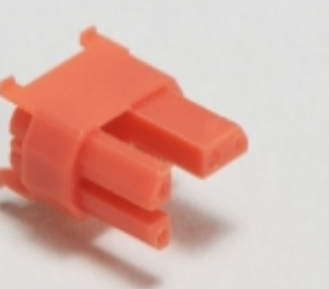

Backplane Coding Keys(60)

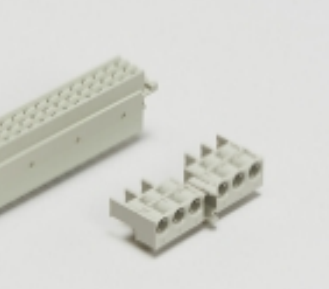

Backplane Connector Housings(4)



Backplane Guide Hardware(37)

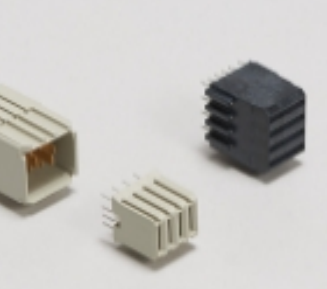

Backplane Power Connectors(6)



Board-to-Board Connector Contacts(2)

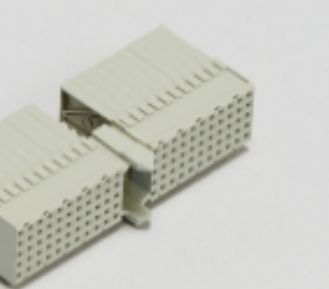

Hard Metric Backplane Connectors (269)

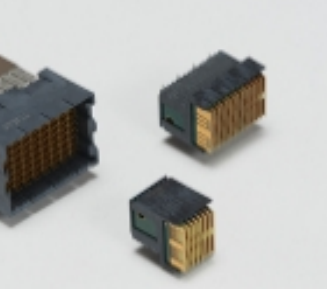

High Speed Backplane Connectors(1)



Insertion & Extraction Tools(2)

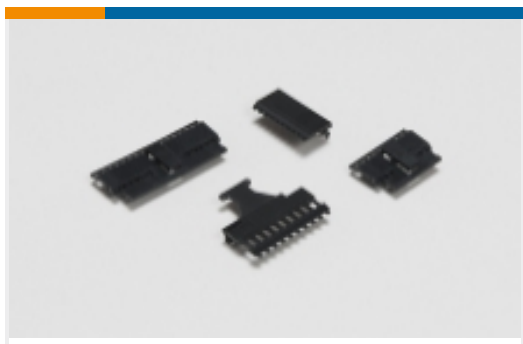

PCB Connector Covers(4)



PCB Connector Shrouds(39)



PCB Ferrules & Shields(19)



Rectangular Power Connectors(87)

## Customers Also Bought



TE Part #5747842-4  
25 MSFL PLUG RA 318 (IN,FM,BL)



TE Part #640456-2  
02P MTA100 HDR ASSY F/L SQ STR

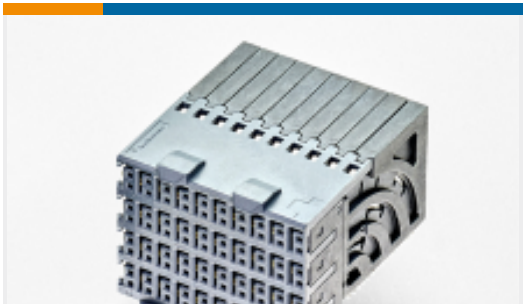

TE Part #2170903-1  
RECEPTACLE HM-EZD+, 4PAIRS  
10COLUMNS



TE Part #2102353-4  
CeeLok FAS-T, Plug Kit, ZnNi, A

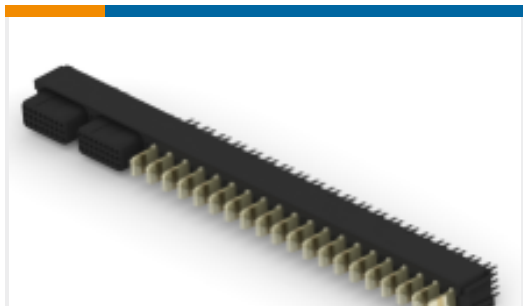

TE Part #6646272-1  
CONN,SKT,STR,COMPL,FLATPAQ



TE Part #1055331-1  
2098 3251 94



TE Part #1757826-6  
AMPLIMITE,ASY,RCPT,FB,90,ZN,6

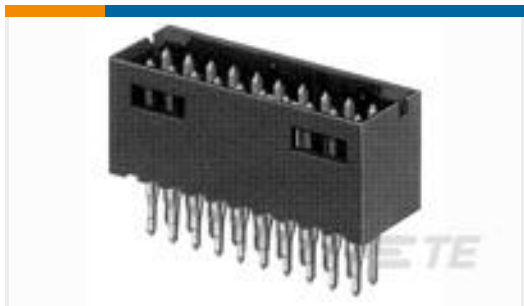

TE Part #102557-1  
40 MODII HDR DRST SHRD A/PIN

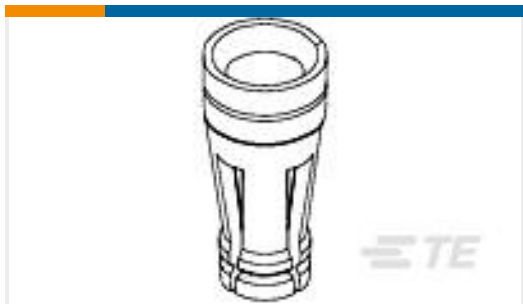

TE Part #8-1437514-0  
M8134-HC-5P2=HOLTITE CONTACT 3



TE Part #8-1437514-1  
M8134-HC-6P2=HOLTITE GOLD 3.2.

## Documents

### Product Drawings

[SLIM UPM 4POS. R/A HDR ASSEMBL](#)

English

### CAD Files

[Customer View Model](#)

[ENG\\_CVM\\_CVM\\_1903977-1\\_E.2d\\_dxf.zip](#)

English

[3D PDF](#)





3D

**Customer View Model**

[ENG\\_CVM\\_CVM\\_1903977-1\\_E.3d\\_igs.zip](#)

English

**Customer View Model**

[ENG\\_CVM\\_CVM\\_1903977-1\\_E.3d\\_stp.zip](#)

English

By downloading the CAD file I accept and agree to the [Terms and Conditions](#) of use.

---

**Datasheets & Catalog Pages**

[POWER\\_CONNECTORS\\_CATALOG\\_SEC01\\_BOARD\\_TO\\_BOARD](#)

English

[1-1773718-4\\_POWER\\_CONNECTORS\\_QRG\\_CN](#)

[1-1773718-5\\_POWER\\_CONNECTORS\\_QRG\\_TCN](#)

[1-1773718-6\\_POWER\\_CONNECTORS\\_QRG\\_JA](#)

Japanese

[2\\_PIECE\\_POWER\\_CONNECTORS\\_qrg\\_4-1773458-1](#)

English

---

**Product Specifications**

[Application Specification](#)

Japanese

---

**Product Environmental Compliance**

[TE Material Declaration](#)

English

---

**Agency Approvals**

[Agency Approval Document](#)

English