



Dynamic Series | Dynamic 1000 Series

TE Internal #: 1903122-1

Connector Contact, Tab, Component-to-Wire, 22 – 18 AWG Wire Size, .34 – .86 mm² Wire Size, Tin, Reel & Box, Wire & Cable, 5 A, Dynamic 1000 Series

[View on TE.com >](#)

Connectors > PCB Connectors > Wire-to-Board Connectors > Wire-to-Board Connector Contacts >

Contact: Component To Wire; 3-5A, 30-18 Wire Size



Contact Type: **Tab**

Connector System: **Component-to-Wire**

Wire Size: **.34 – .86 mm²**

Contact Mating Area Plating Material: **Tin**

All Contact: Component To Wire; 3-5A, 30-18 Wire Size (30)

Features

Product Type Features

Connector System	Component-to-Wire
Connector & Contact Terminates To	Wire & Cable

Contact Features

Mating Tab Width	.7 mm[.027 in]
Mating Tab Thickness	.5 mm[.02 in]
Contact Type	Tab
Contact Mating Area Plating Material	Tin
Contact Current Rating (Max)	5 A

Dimensions

Wire Size	.34 – .86 mm ²
-----------	---------------------------

Usage Conditions

Operating Temperature Range	-55 – 105 °C[-67 – 221 °F]
-----------------------------	----------------------------

Operation/Application

Circuit Application	Signal
---------------------	--------

Packaging Features

Packaging Method	Reel & Box
------------------	------------



Product Compliance

[For compliance documentation, visit the product page on TE.com>](#)

EU RoHS Directive 2011/65/EU	Compliant
EU ELV Directive 2000/53/EC	Compliant
China RoHS 2 Directive MIIT Order No 32, 2016	No Restricted Materials Above Threshold
EU REACH Regulation (EC) No. 1907/2006	Current ECHA Candidate List: JUNE 2023 (235) Candidate List Declared Against: JUNE 2023 (235) Does not contain REACH SVHC
Halogen Content	Low Halogen - Br, Cl, F, I < 900 ppm per homogenous material. Also BFR/CFR/PVC Free
Solder Process Capability	Not applicable for solder process capability

Product Compliance Disclaimer

This information is provided based on reasonable inquiry of our suppliers and represents our current actual knowledge based on the information they provided. This information is subject to change. The part numbers that TE has identified as EU RoHS compliant have a maximum concentration of 0.1% by weight in homogenous materials for lead, hexavalent chromium, mercury, PBB, PBDE, DBP, BBP, DEHP, DIBP, and 0.01% for cadmium, or qualify for an exemption to these limits as defined in the Annexes of Directive 2011/65/EU (RoHS2). Finished electrical and electronic equipment products will be CE marked as required by Directive 2011/65/EU. Components may not be CE marked. Additionally, the part numbers that TE has identified as EU ELV compliant have a maximum concentration of 0.1% by weight in homogenous materials for lead, hexavalent chromium, and mercury, and 0.01% for cadmium, or qualify for an exemption to these limits as defined in the Annexes of Directive 2000/53/EC (ELV). Regarding the REACH Regulation, the information TE provides on SVHC in articles for this part number is based on the latest European Chemicals Agency (ECHA) 'Guidance on requirements for substances in articles' posted at this URL: <https://echa.europa.eu/guidance-documents/guidance-on-reach>

Compatible Parts

<p>TE Part # 1891526-1 EXTRACTION TOOL FOR DYNAMIC 1000 SERIES</p>	<p>TE Part # 2305570-1 Strip Terminal Cutter-Side Feed-No Crimp</p>	<p>TE Part # 2151083-1 OCEAN_2.0_APPLICATOR-S-055F070F</p>	<p>TE Part # 2151083-2 OCEAN_2.0_APPLICATOR-S-055F070FA</p>



Also in the Series | **Dynamic 1000 Series**

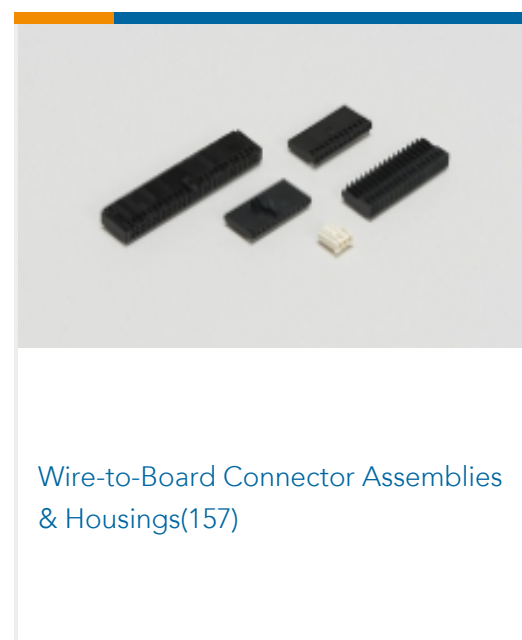
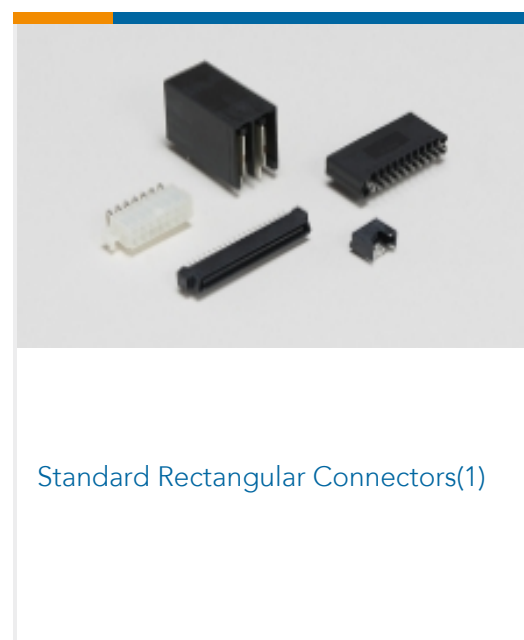
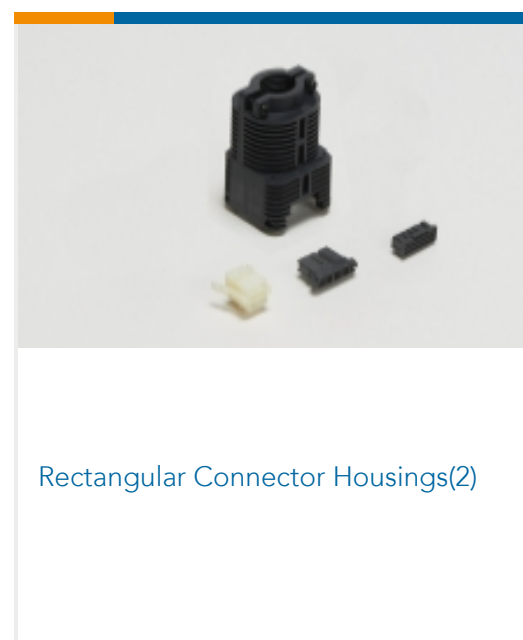
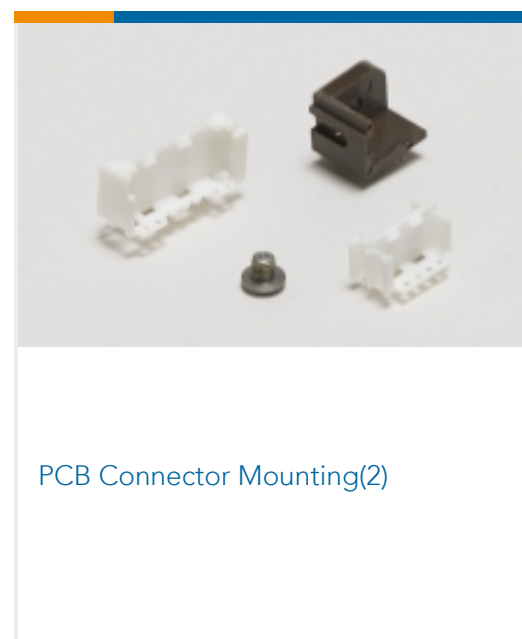
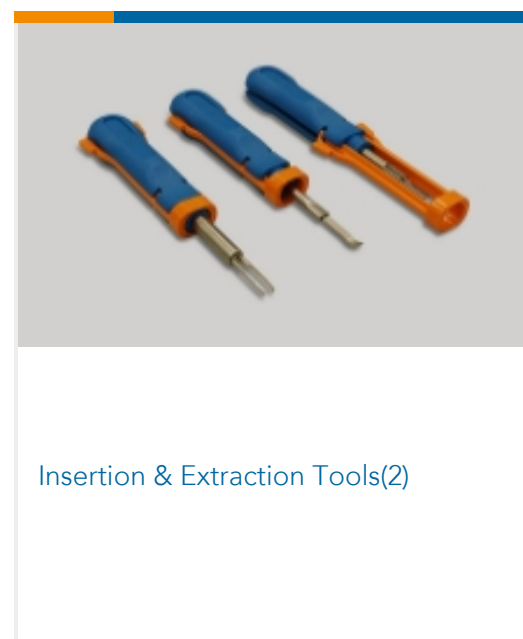
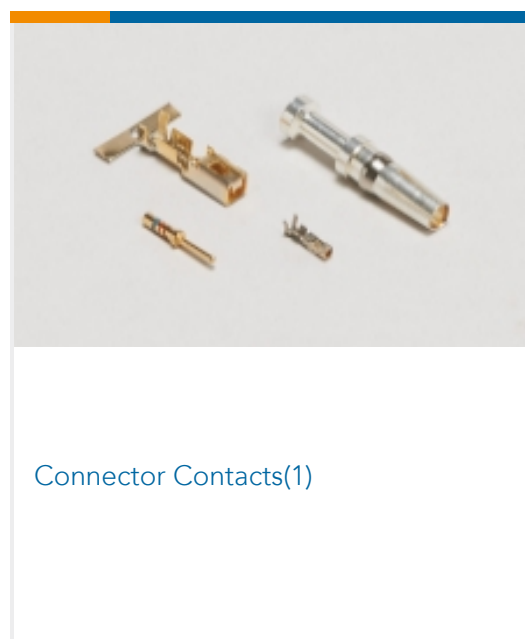



Wire-to-Board Connector Contacts(39)

Customers Also Bought

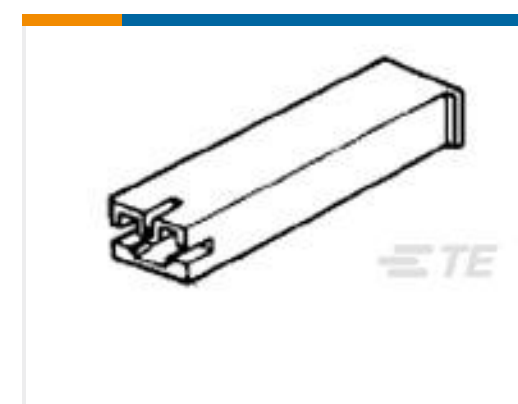
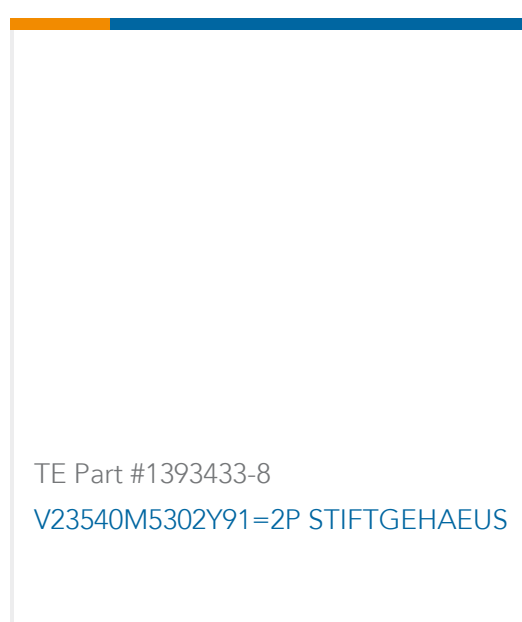
TE Part #1-1827863-5
DYNAMIC 1100D REC HSG 30P X
BLACKTE Part #1-1318115-9
Receptacle and Tab Housing: 2.5 mm
Pitch, 250VTE Part #353715-2
DYNAMIC D-3 REC CONT. 3L AU 0.38TE Part #1903114-2
DYNAMIC D1000 TAB CONT AU 0.38
um 2L REELTE Part #1-2333149-5
DYNAMIC 1100D REC HSG 10P X
BLACK 33%GFTE Part #3-641242-3
03P MTA100 CONN ASSY NATLTE Part #3-968696-2
MOS STIFT-GEH 4PTE Part #172074-2
POSITIVE LOCK 187 HOUSING
RECEPTACLETE Part #1393433-8
V23540M5302Y91=2P STIFTGEHAEUS

Documents

Product Drawings

[DYNAMIC D1000 TAB CONT TIN \(2L\) REEL](#)

English

CAD Files

[3D PDF](#)

3D

Customer View Model

[ENG_CVM_CVM_1903122-1_C.2d_dxf.zip](#)



English

Customer View Model

[ENG_CVM_CVM_1903122-1_C.3d_igs.zip](#)

English

Customer View Model

[ENG_CVM_CVM_1903122-1_C.3d_stp.zip](#)

English

By downloading the CAD file I accept and agree to the [Terms and Conditions](#) of use.

Datasheets & Catalog Pages

[1-1773732-4_DYNAMIC_SERIES_CATALOG_ENGLISH](#)

Japanese

[1-1773732-4_DYNAMIC_SERIES_CATALOG_ENGLISH](#)

English

Product Specifications

[Application Specification](#)

English

Product Environmental Compliance

[MD_1903122-1_071620142334_dmtec](#)

English

[MD_1903122-1_071620142334_dmtec](#)

English

Instruction Sheets

[Instruction Sheet \(non U.S.\)](#)

English

Agency Approvals

[TUV Certificate](#)

English