

189727-1 ✓ ACTIVE



MATE-N-LOK

| Commercial Pin and Socket Connectors, Mini-Universal MATE-N-LOK, Mini-Universal MATE-N-LOK 2

TE Internal #: 189727-1

Insertion & Extraction Tools, Contact Extraction, Contact-to-Housing, Mini-Universal MATE-N-LOK

[View on TE.com >](#)

Application Tooling > Insertion & Extraction Tools



Insertion & Extraction Tool Type: **Contact Extraction**

Insertion & Extraction Tool Application: **Contact-to-Housing**

Features

Product Type Features

Insertion & Extraction Tool Type	Contact Extraction
Insertion & Extraction Tool Application	Contact-to-Housing

Product Compliance

[For compliance documentation, visit the product page on TE.com>](#)







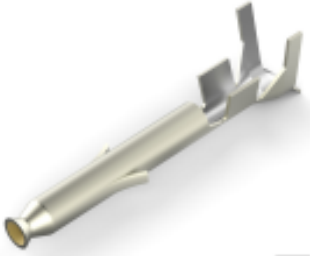
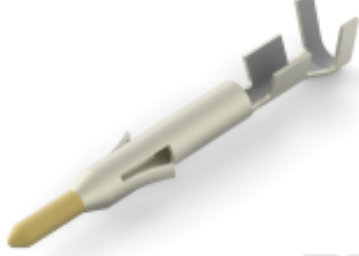
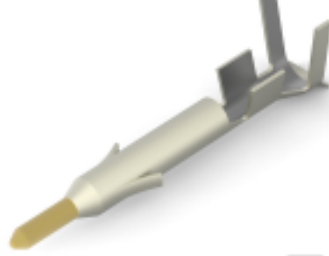
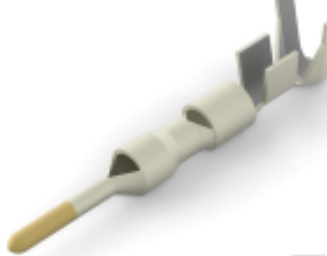
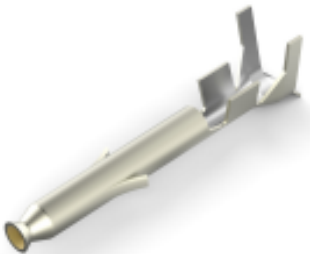
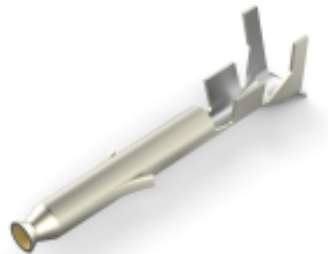

EU RoHS Directive 2011/65/EU	Compliant
EU ELV Directive 2000/53/EC	Compliant
China RoHS 2 Directive MIIT Order No 32, 2016	No Restricted Materials Above Threshold
EU REACH Regulation (EC) No. 1907/2006	Current ECHA Candidate List: JUNE 2023 (235) Candidate List Declared Against: JUNE 2023 (235) Does not contain REACH SVHC
Halogen Content	Low Halogen - Br, Cl, F, I < 900 ppm per homogenous material. Also BFR/CFR/PVC Free
Solder Process Capability	Not reviewed for solder process capability

Product Compliance Disclaimer

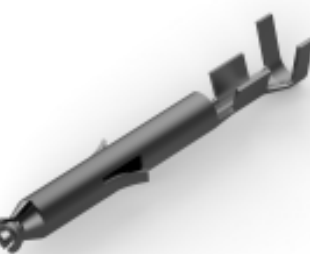
This information is provided based on reasonable inquiry of our suppliers and represents our current actual knowledge based on the information they provided. This information is subject to change. The part numbers that TE has identified as EU RoHS compliant have a maximum concentration of 0.1% by weight in homogenous materials for lead, hexavalent chromium, mercury, PBB, PBDE, DBP, BBP, DEHP, DIBP, and 0.01% for cadmium, or qualify for an exemption to these limits as defined in the Annexes of Directive 2011/65/EU (RoHS2). Finished electrical and electronic equipment products will be CE marked as required by Directive 2011/65/EU. Components may not be CE marked. Additionally, the part

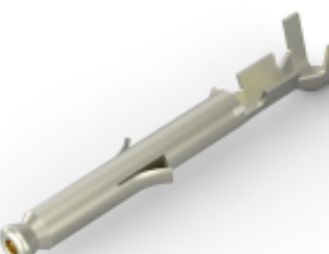
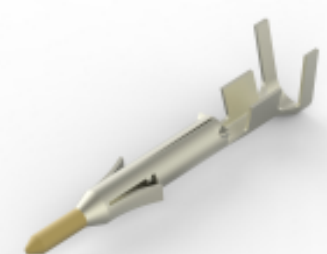
numbers that TE has identified as EU ELV compliant have a maximum concentration of 0.1% by weight in homogenous materials for lead, hexavalent chromium, and mercury, and 0.01% for cadmium, or qualify for an exemption to these limits as defined in the Annexes of Directive 2000/53/EC (ELV). Regarding the REACH Regulation, the information TE provides on SVHC in articles for this part number is based on the latest European Chemicals Agency (ECHA) 'Guidance on requirements for substances in articles' posted at this URL: <https://echa.europa.eu/guidance-documents/guidance-on-reach>

Compatible Parts

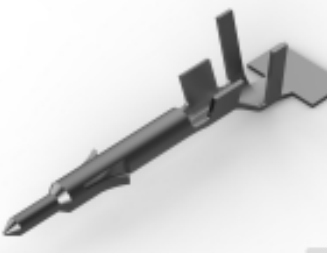
 <p>TE Part # 1-770988-1 MINI UMNL SOK 22-18AWG LP LF</p>	 <p>TE Part # 1-770985-0 MINI UMNL PIN 26-22AWG AU LP</p>	 <p>TE Part # 1-770987-0 MINI UMNL PIN 22-18 AWG AU LP</p>	 <p>TE Part # 1-794228-0 MINI UMNL2 PIN 22-18 AWG AU LP</p>
 <p>TE Part # 770988-3 MINI UMNL SOK 22-18AWG AU LP</p>	 <p>TE Part # 1-770988-0 MINI UMNL SOK 22-18AWG AU</p>	 <p>TE Part # 1-794059-0 MINI UMNL PIN L/P LF</p>	 <p>TE Part # 770988-1 MINI UMNL SOK 22-18AWG SN LP</p>
 <p>TE Part # 770986-1 MINI UMNL SOK 26-22AWG SN LP</p>	 <p>TE Part # 794058-1 MINI UMNL SOK L/P</p>	 <p>TE Part # 170365-3 MINI UNIVERSAL M-N-L SOCKET LP</p>	 <p>TE Part # 170364-3 MINI UNIVERSAL M-N-L PIN LP</p>
 <p>TE Part # 794224-1 MINI UMNL2 PIN 30-26 AWG SN LP</p>	 <p>TE Part # 770985-1 MINI UMNL PIN 26-22AWG SN LP</p>	 <p>TE Part # 1-794407-1 MINI UMNL SOK 20-16 AWG AU LF</p>	 <p>TE Part # 171638-1 MINI U-M-N-L PIN CONT. L.P</p>



Also in the Series | Commercial Pin and Socket Connectors

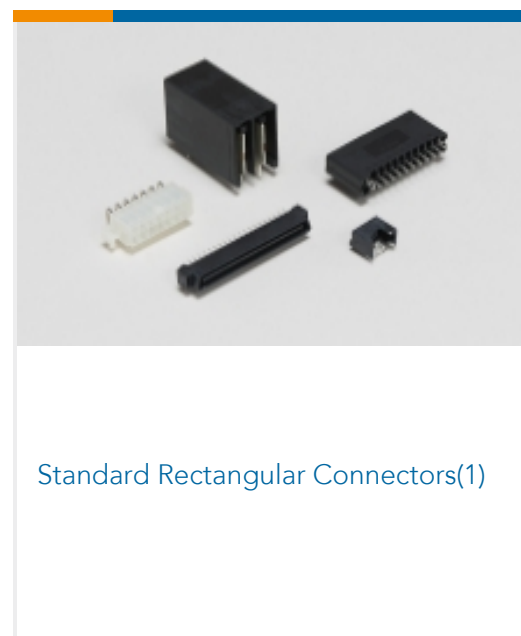
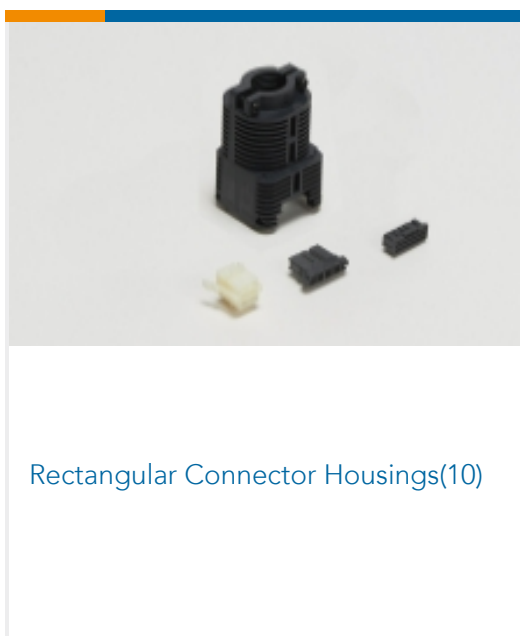
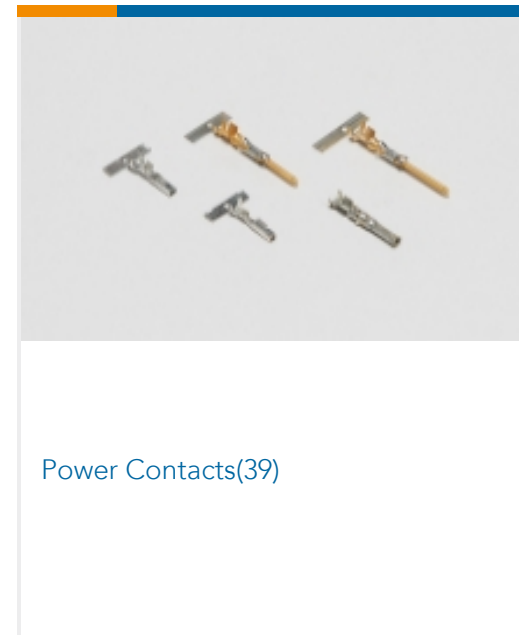
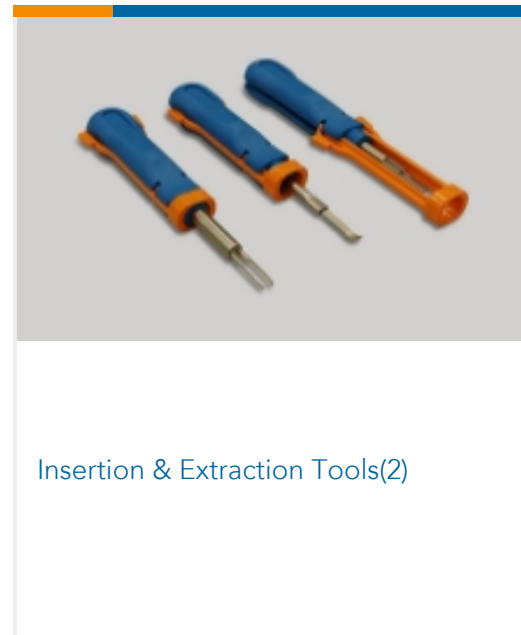
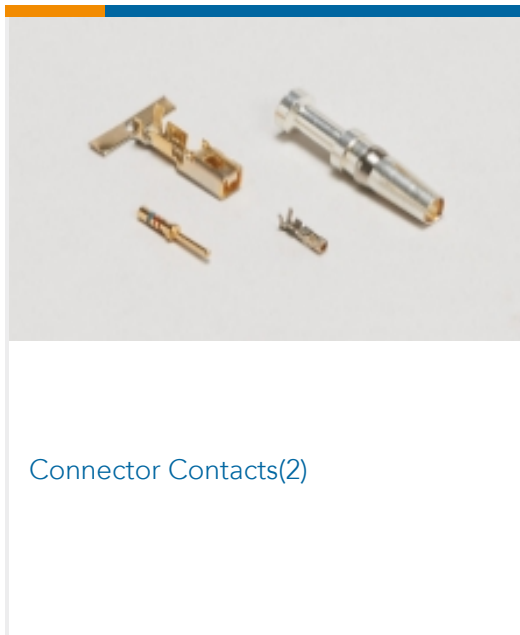

Also in the Series | Mini-Universal MATE-N-LOK

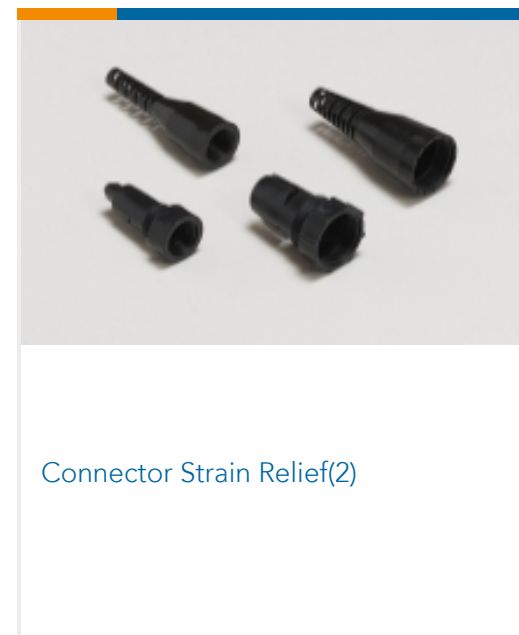
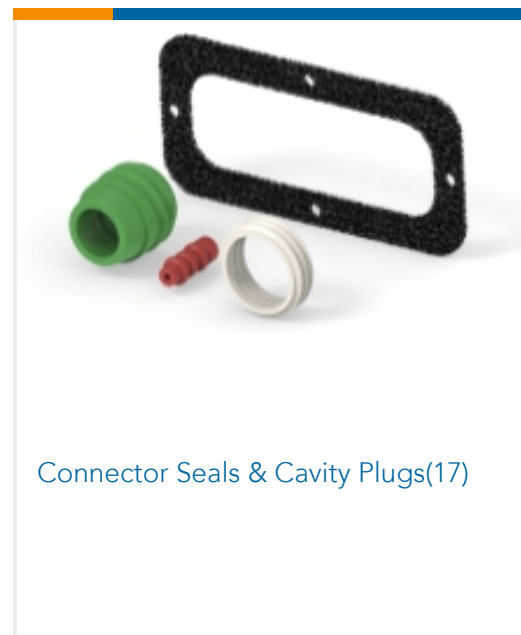
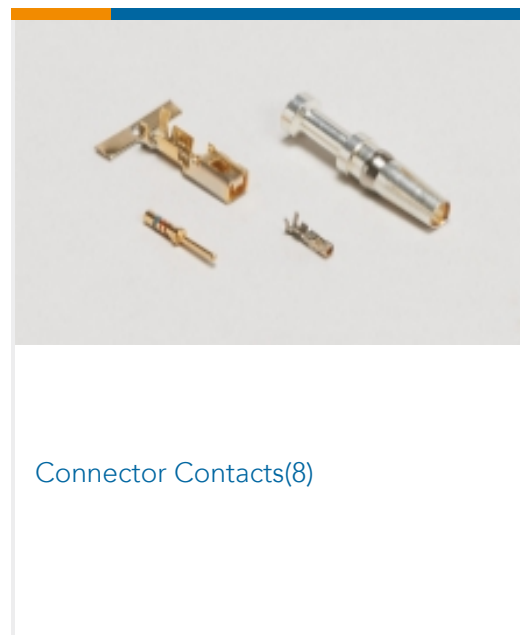
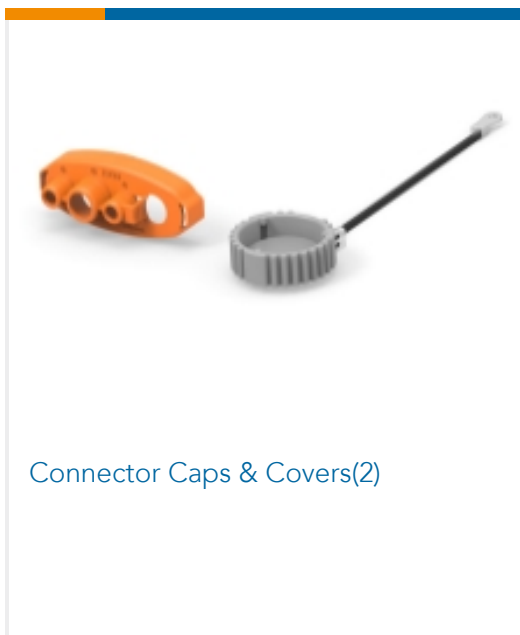



Insertion & Extraction Tools(1)



PCB Headers & Receptacles(1)

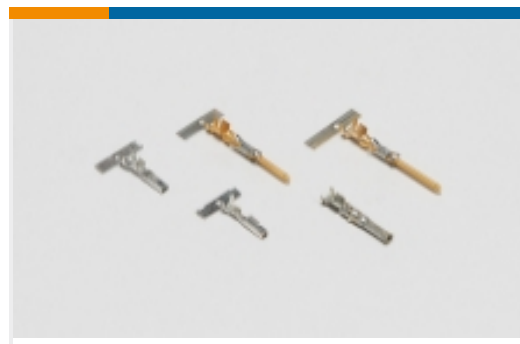

Power Contacts(84)

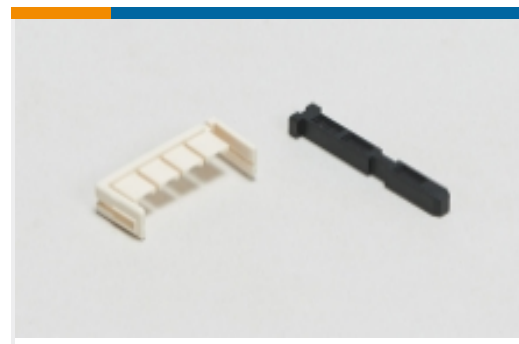

Rectangular Connector Keying Plugs(2)



Rectangular Connector Locking(2)



Rectangular Power Connectors(244)

Also in the Series | Mini-Universal MATE-N-LOK 2



Connector Contacts(8)



Insertion & Extraction Tools(1)

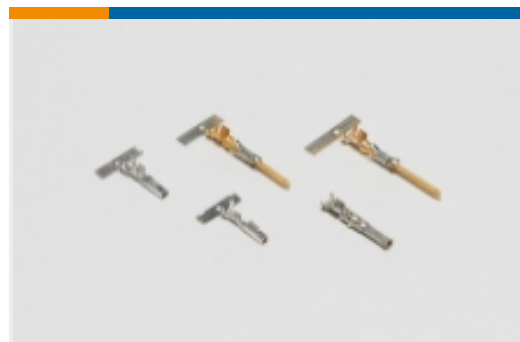

Power Contacts(33)



Rectangular Power Connectors(45)

Customers Also Bought



TE Part #350735-1
12P UMNL PLUG HSG



TE Part #350812-1
STR/REL CLAMP UMNL

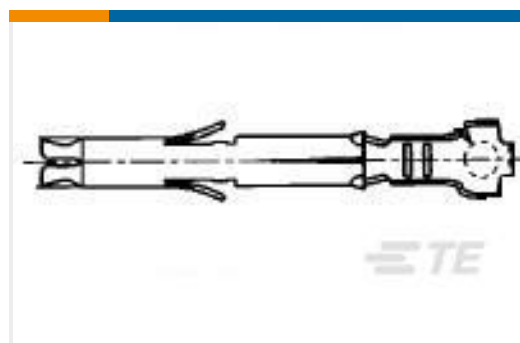

TE Part #170365-1
MINI UNIVERSAL M-N-L SOCKET LP



TE Part #1445997-1
CONTACT, 120 PWR PROD, 6 AWG

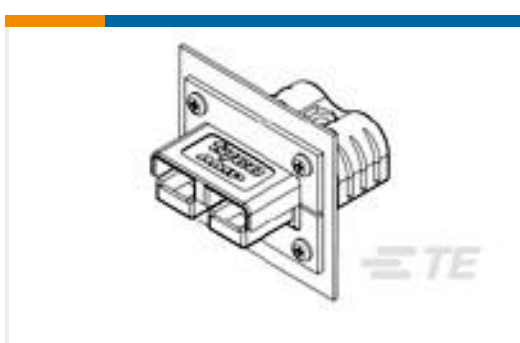

TE Part #1744090-1
PANEL MT BRACKET, 120 SERIES



TE Part #1634201-2
PRFDA1-16F-BB0BW



TE Part #234604-1
SAHT 2.5 SIG DBL-L M REC TAB 26-22 ASSY



TE Part #1SNA162314R2400
HD 6/14.SDH3

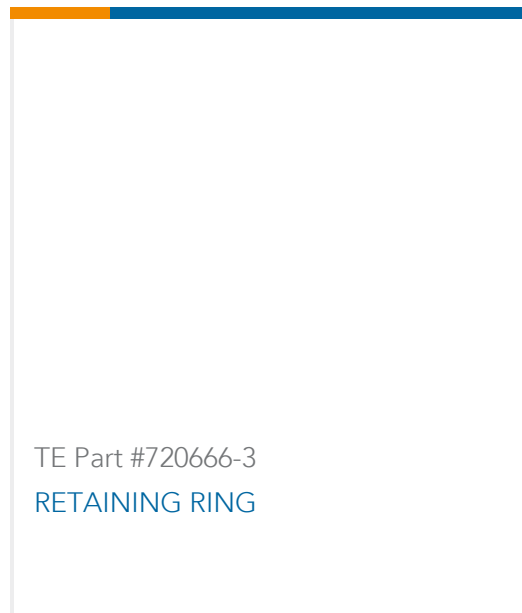

Documents

Instruction Sheets

[Instruction Sheet \(U.S.\)](#)

English

[Extraction Tool 189727-1 for Mini-Universal MATE-N-LOK Contacts](#)

English

[Instruction Sheet \(U.S.\)](#)

English