

185026-1 ✓ ACTIVE

AMP | Junior Power Timer, Timer Connector System

TE Internal #: 185026-1

Automotive Terminals, Receptacle, Mating Tab Width 2.8 mm [.11 in], Tab Thickness .8 mm [.031 in], 22 – 17 AWG Wire Size, Timer Connector System

[View on TE.com >](#)



Terminals & Splices > Automotive Terminals



Terminal Type: **Receptacle**

Mating Tab Width: **2.8 mm [.11 in]**

Mating Tab Thickness: **.8 mm [.031 in]**

Terminal Transmits: **0 – 24 A (Low Power)**

Wire Size: **22 – 17 AWG**

Features

Product Type Features

Receptacle Style	180°
Sealable	Yes
Primary Locking Feature	Locking Lance

Body Features

Terminal Seal Type	Single Wire Seal (SWS)
--------------------	------------------------

Contact Features

Contact Size	2.8mm
Contact Fabrication	Stamped & Formed
Wire Contact Termination Area Plating Material	Tin
Typical Current Rating	5 A
Crimp Type	F-Crimp
Terminal Type	Receptacle
Mating Tab Width	2.8 mm [.11 in]
Mating Tab Thickness	.8 mm [.031 in]
Interface Plating	Tin (Sn)

Termination Features

Termination Method to Wire & Cable	Crimp
------------------------------------	-------



Product Terminates To

Wire

Dimensions

Compatible Insulation Diameter Range	3.4 mm[.134 in]
Wire Size	.35 – 1 mm ²
Wire Size Search	17 AWG, 18 AWG, 19 AWG, 20 AWG, 21 AWG, 22 AWG
Tab Length	21 mm[.826 in]

Usage Conditions

Insulation Option	Uninsulated
Operating Temperature (Max)	100 °C[212 °F]
Operating Temperature Range	-40 – 100 °C[-40 – 212 °F]

Operation/Application

Compatible With Wire Base Material	Copper
------------------------------------	--------

Packaging Features

Packaging Quantity	3500
Packaging Method	Reel

Other

Terminal Transmits	0 – 24 A (Low Power)
--------------------	----------------------

Product Compliance

[For compliance documentation, visit the product page on TE.com>](#)

EU RoHS Directive 2011/65/EU	Compliant
EU ELV Directive 2000/53/EC	Compliant
China RoHS 2 Directive MIIT Order No 32, 2016	No Restricted Materials Above Threshold
EU REACH Regulation (EC) No. 1907/2006	Current ECHA Candidate List: JUNE 2023 (235) Candidate List Declared Against: JUNE 2023 (235) Does not contain REACH SVHC
Halogen Content	Low Halogen - Br, Cl, F, I < 900 ppm per homogenous material. Also BFR/CFR/PVC Free
Solder Process Capability	Not applicable for solder process capability

Product Compliance Disclaimer

This information is provided based on reasonable inquiry of our suppliers and represents our current actual knowledge based on the information they provided. This information is subject to change. The part numbers that TE has identified as EU RoHS compliant have a maximum concentration of 0.1% by weight in homogenous materials for lead, hexavalent chromium, mercury, PBB, PBDE, DBP, BBP, DEHP, DIBP, and 0.01% for cadmium, or qualify for an exemption to these limits as defined in the Annexes of Directive 2011/65/EU (RoHS2). Finished electrical and electronic equipment products will be CE marked as required by Directive 2011/65/EU. Components may not be CE marked. Additionally, the part numbers that TE has identified as EU ELV compliant have a maximum concentration of 0.1% by weight in homogenous materials for lead, hexavalent chromium, and mercury, and 0.01% for cadmium, or qualify for an exemption to these limits as defined in the Annexes of Directive 2000/53/EC (ELV). Regarding the REACH Regulation, the information TE provides on SVHC in articles for this part number is based on the latest European Chemicals Agency (ECHA) 'Guidance on requirements for substances in articles' posted at this URL: <https://echa.europa.eu/guidance-documents/guidance-on-reach>

Compatible Parts



TE Part # CAT-T4827-CH8172
Timer Connector Housing



TE Part # 4-1579007-3
EXTRACTION TOOL KIT



TE Part # 1-1579007-6
EXTRACTION TOOL



TE Part # 2151257-1
OCEAN_2.0_Applicator-S-070F1510



TE Part # 2151257-2
OCEAN_2.0_Applicator-S-070F1510A



TE Part # 58613-1
PRO-CRIMP TOOL JPT REC

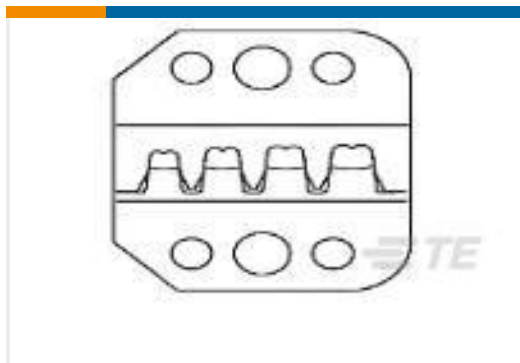

TE Part # 58613-2
PRO-CRIMP DIE JPT REC



TE Part # 7-2151257-1
OCEAN_2.0_Applicator-S-070F1510



TE Part # 7-2151257-2
OCEAN_2.0_Applicator-S-070F1510A



TE Part # 7-2151257-7
OCEAN_2.0_SPARE_PART_KIT-070F1510



TE Part # 2-2151257-1
OCEAN_2.0_Applicator-S-070F1510



TE Part # 2-2151257-2
OCEAN_2.0_Applicator-S-070F1510A

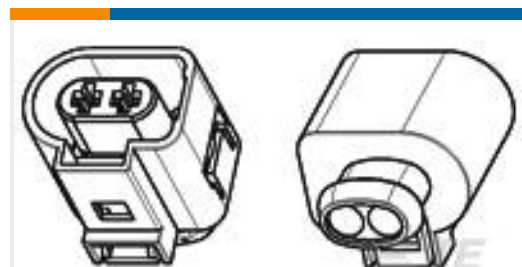

TE Part # 1-967412-5
JPT GEH ASSY 2P

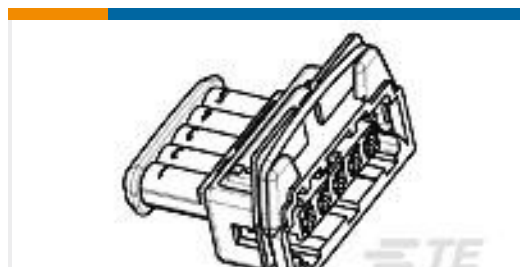

TE Part # 953310-3
5W JPT/SWS CET CON

Also in the Series | Junior Power Timer



Automotive Connector Caps & Covers (5)



Automotive Housings(252)



Automotive Terminals(86)



Busbars & Terminals(1)



Connector Seals & Cavity Plugs(10)



Insertion & Extraction Tools(8)



Module Components(6)



Other Automotive Connector Accessories(1)



PCB Headers & Receptacles(1)

Also in the Series | Timer Connector System



Automotive Connector Caps & Covers (12)

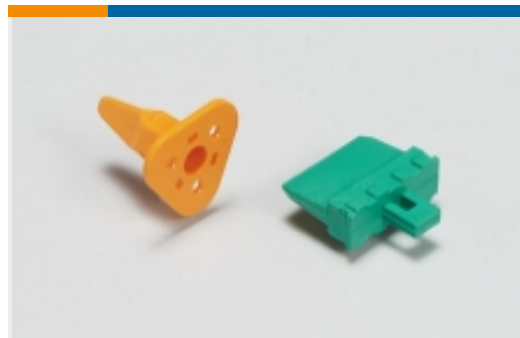

Automotive Connector Locks & Position Assurance(17)



Automotive Housings(233)



Automotive Terminals(145)

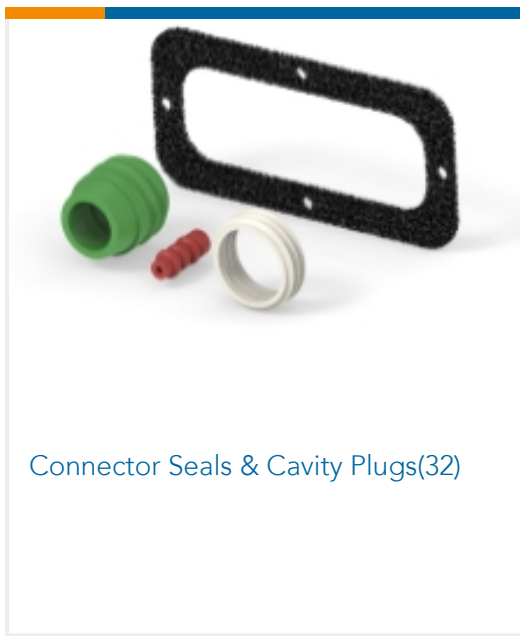

Connector Seals & Cavity Plugs(32)

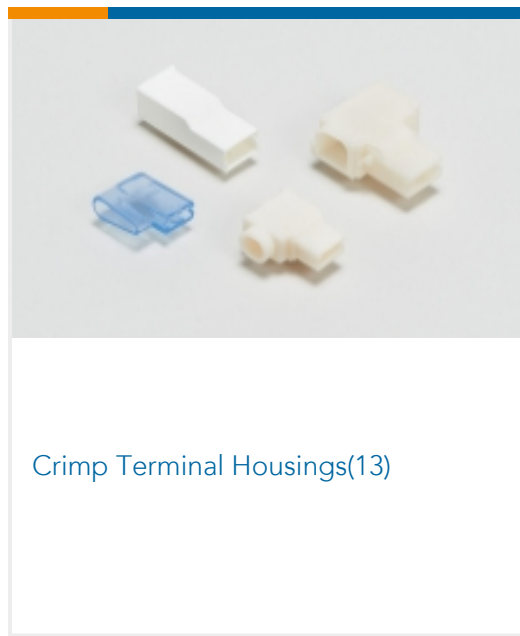

Crimp Terminal Housings(13)

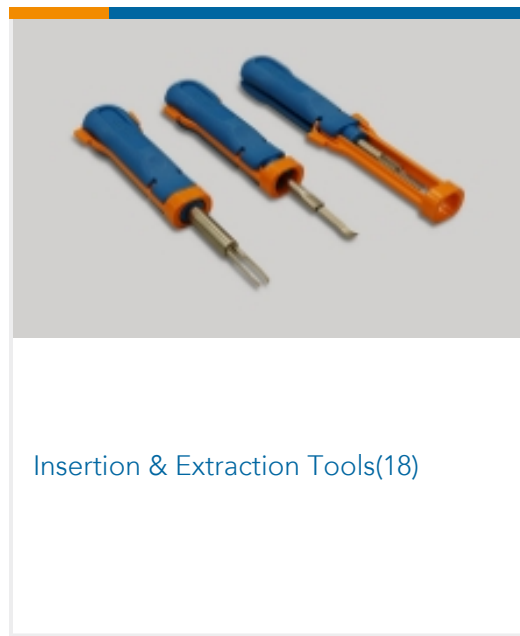

Insertion & Extraction Tools(18)

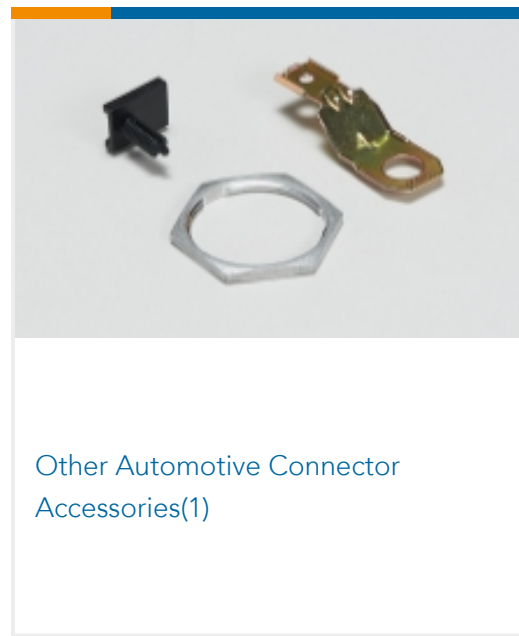

Other Automotive Connector Accessories(1)



PCB Headers & Receptacles(82)

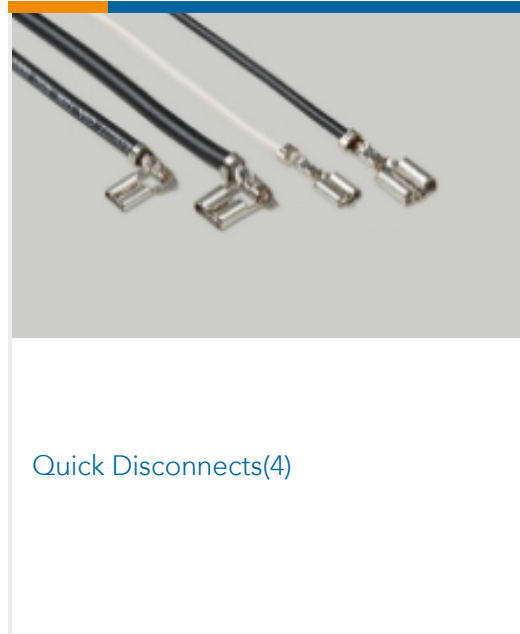

Quick Disconnects(4)

Customers Also Bought



TE Part #52947
PG SP SPD 22-16COMM 22-18MIL 4



TE Part #1-962352-1
10P MESSERLEIS-GEH

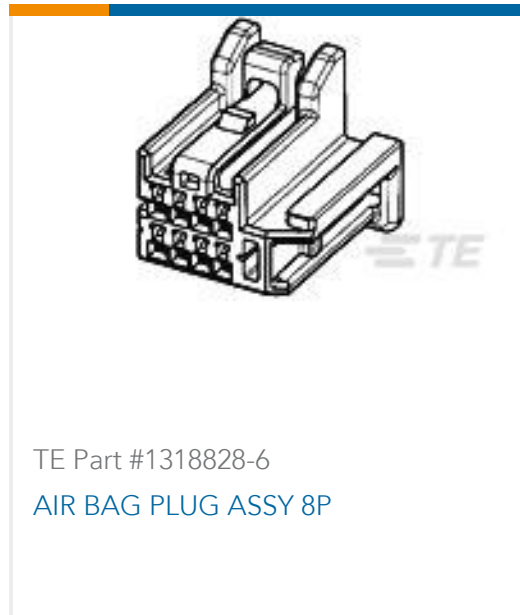

TE Part #1318828-6
AIR BAG PLUG ASSY 8P



TE Part #1801434-2
12pos MQS .63 header 90deg THR

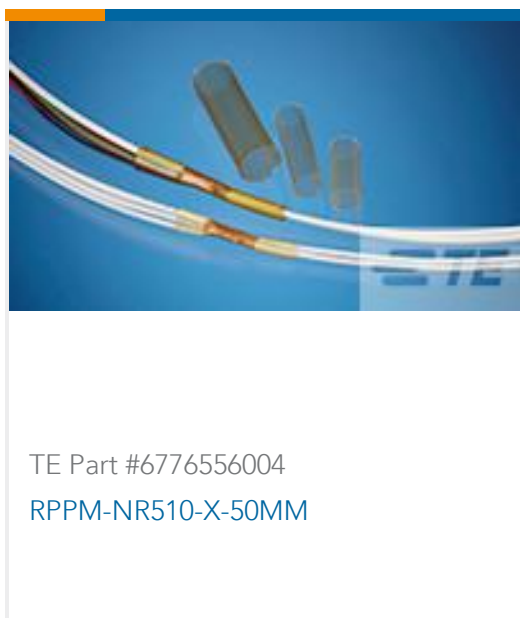

TE Part #6776556004
RPPM-NR510-X-50MM



TE Part #1-1627087-0
RECEPTACLE, FLAG QC 4.8x0.8 (H25411)



TE Part #150572-2
MINI FASTON 110 REC 20-16 AWG TPBR



TE Part #1612121-5
SQUIB 2POS PLUG HSG



TE Part #1801823-3
4POS,MCON 0.5 CB,REC HSG,BLUE, ASSY,SLD



TE Part #2138710-1
PLUG HOUSING, 1 POSITION, 180

Documents



Product Drawings

JPT F REC 2.8 Contact SWS Sn

English

CAD Files

3D PDF

3D

Customer View Model

[ENG_CVM_CVM_185026-1_B.2d_dxf.zip](#)

English

Customer View Model

[ENG_CVM_CVM_185026-1_B.3d_igs.zip](#)

English

Customer View Model

[ENG_CVM_CVM_185026-1_B.3d_stp.zip](#)

English

By downloading the CAD file I accept and agree to the [Terms and Conditions](#) of use.

Product Specifications

Application Specification

French

Instruction Sheets

Instruction Sheet (non U.S.)

French