

1825360-6 ✓ ACTIVE

[Alcoswitch](#) | [Alcoswitch DIP](#), [Alcoswitch DIP ADE](#)

TE Internal #: 1825360-6

DIP & SIP Switches, Switch, Gold Flash, Black Housing,
Polyphenylene Sulfide (PPS), Auto-Insertable, 10 Switch, -30 – 85 °
C, DIP, Alcoswitch DIP

[View on TE.com >](#)



Relays, Contactors & Switches > Switches > DIP & SIP Switches

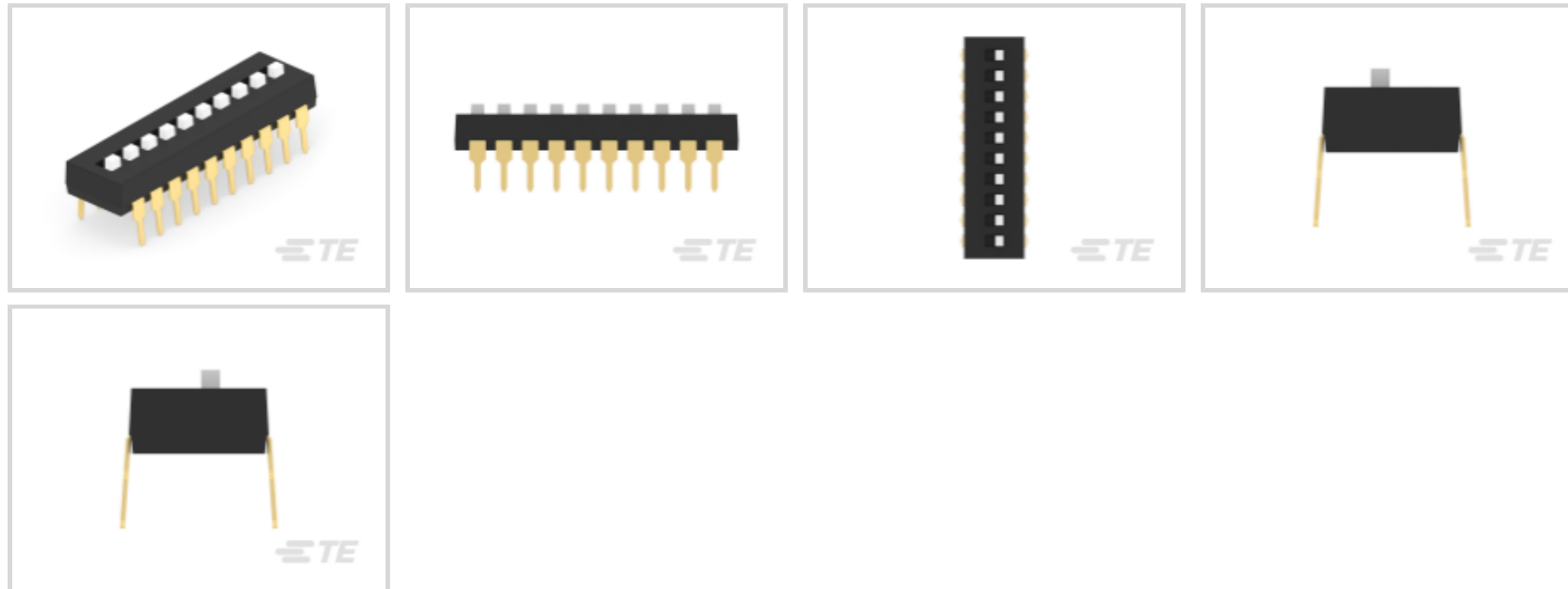

DIP & SIP Switch Product Type: **Switch**

DIP & SIP Switch Contact Mating Area Plating Material: **Gold Flash**

DIP & SIP Switch Housing Color: **Black**

DIP & SIP Switch Housing Material: **Polyphenylene Sulfide (PPS)**

Auto-Insertable: **Yes**

Features

Product Type Features

DIP & SIP Switch Product Type	Switch
Sealed DIP & SIP Switch	No
DIP & SIP Switch Type	DIP
Actuator Style	Extended, Slide

Configuration Features

Number of Positions	10
Number of Switches	10
Configuration (Pole-Throw)	Single Pole - Single Throw

Electrical Characteristics

DIP & SIP Switch Voltage Rating	5 VDC
---------------------------------	-------

Body Features

Actuator Color	White
----------------	-------

Contact Features

--	--

Solder Tail Contact Plating	Gold over Nickel
	1.2 μin
DIP & SIP Switch Contact Mating Area Plating Material	Gold Flash
Auto-Insertable	Yes
DIP & SIP Switch Contact Current Rating	1 A
Contact Base Material	Copper Alloy

Termination Features

Termination Post Length	4 mm[.157 in]
-------------------------	---------------

Mechanical Attachment

Mounting Angle	Vertical
DIP & SIP Switch Mounting Type	Through Hole

Housing Features

DIP & SIP Switch Housing Color	Black
DIP & SIP Switch Housing Material	Polyphenylene Sulfide (PPS)
DIP & SIP Switch Centerline	2.54 mm[.1 in]

Dimensions

Height	3.5 mm[.138 in]
Length	27.38 mm[1.078 in]

Usage Conditions

Operating Temperature Range	-30 – 85 °C
-----------------------------	-------------

Industry Standards

UL Flammability Rating	UL 94V-0
------------------------	----------

Packaging Features

Packaging Method	Tube
Packaging Quantity	15

Product Compliance

[For compliance documentation, visit the product page on TE.com>](#)

EU RoHS Directive 2011/65/EU	Compliant
EU ELV Directive 2000/53/EC	Compliant
China RoHS 2 Directive MIIT Order No 32, 2016	No Restricted Materials Above Threshold
EU REACH Regulation (EC) No. 1907/2006	

Current ECHA Candidate List: JUNE 2023 (235)
 Candidate List Declared Against: JUNE 2023 (235)
 Does not contain REACH SVHC

Halogen Content Not Low Halogen - contains Br or Cl > 900 ppm.

Solder Process Capability

Wave solder capable to 265°C

Product Compliance Disclaimer

This information is provided based on reasonable inquiry of our suppliers and represents our current actual knowledge based on the information they provided. This information is subject to change. The part numbers that TE has identified as EU RoHS compliant have a maximum concentration of 0.1% by weight in homogenous materials for lead, hexavalent chromium, mercury, PBB, PBDE, DBP, BBP, DEHP, DIBP, and 0.01% for cadmium, or qualify for an exemption to these limits as defined in the Annexes of Directive 2011/65/EU (RoHS2). Finished electrical and electronic equipment products will be CE marked as required by Directive 2011/65/EU. Components may not be CE marked. Additionally, the part numbers that TE has identified as EU ELV compliant have a maximum concentration of 0.1% by weight in homogenous materials for lead, hexavalent chromium, and mercury, and 0.01% for cadmium, or qualify for an exemption to these limits as defined in the Annexes of Directive 2000/53/EC (ELV). Regarding the REACH Regulation, the information TE provides on SVHC in articles for this part number is based on the latest European Chemicals Agency (ECHA) 'Guidance on requirements for substances in articles' posted at this URL: <https://echa.europa.eu/guidance-documents/guidance-on-reach>

Compatible Parts

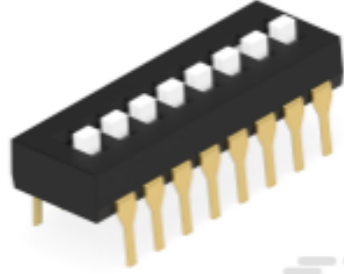

TE Part # 1825057-7
 ADE0804=DIP SWITCH,EXT,THRU/HL



TE Part # 1825057-1
 ADE0204=DIP SWITCH,EXT,THRU/HL



TE Part # 1825057-3
 ADE0404=DIP SWITCH,EXT,THRU/HL



TE Part # 1825057-4
 ADE0504=DIP SWITCH,EXT,THRU/HL

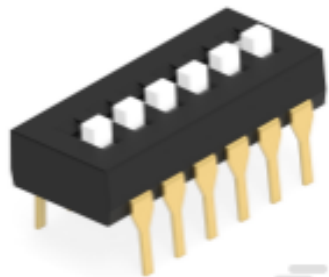

TE Part # 1825057-5
 ADE0604=DIP SWITCH,EXT,THRU/HL

Also in the Series | [Alcoswitch DIP](#)

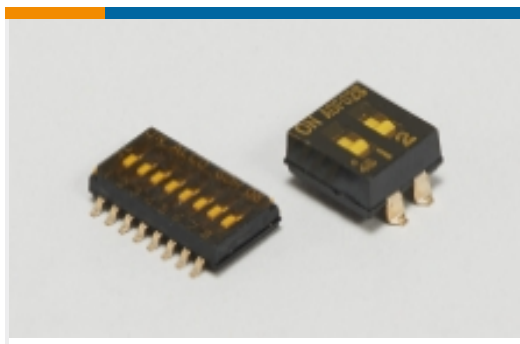

DIP & SIP Switches(241)



Rotary Switches(16)

Also in the Series | [Alcoswitch DIP ADE](#)

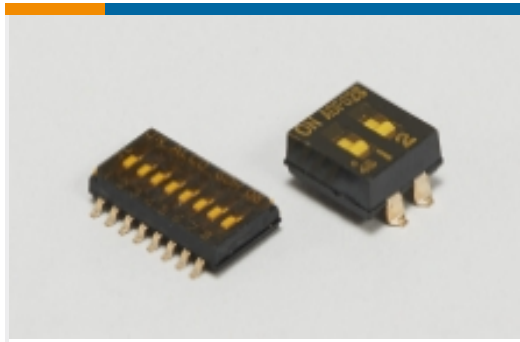

DIP & SIP Switches(26)

Customers Also Bought



TE Part #7-1768019-9
ESSW1-025



TE Part #7-1676966-5
SMW2 120R 5%



TE Part #280520-1
12P AMPMODU II SHRD HDR, ST, TIN

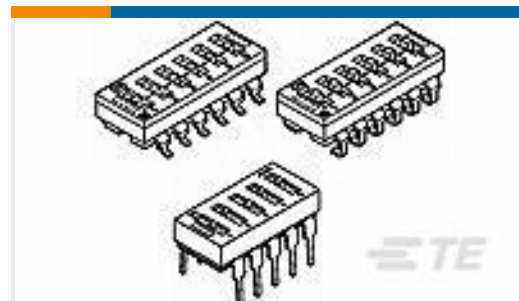

TE Part #1825360-3
ADE04A04=4POS DIP SWITCH



TE Part #2-2176094-0
RP 2A 0.25W 187K 0.1% 25PPM 1K RL



TE Part #2176338-7
CRGCC 0402 10R 5%

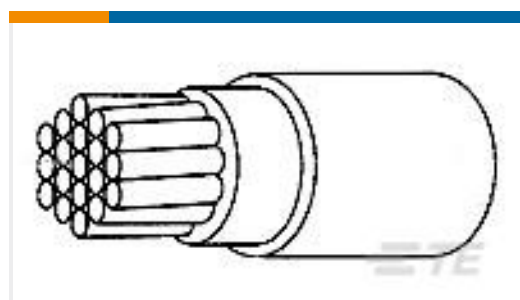

TE Part #7724153001
99M0111-24-2L

Documents

[Product Drawings](#)

[ADE10A04=10 POS DIP SWITCH](#)

English

[CAD Files](#)

[Customer View Model](#)

[ENG_CVM_CVM_1825360-6_C.3d_igs.zip](#)



English

Customer View Model

[ENG_CVM_CVM_1825360-6_C.3d_stp.zip](#)

English

Customer View Model

[ENG_CVM_CVM_1825360-6_C.2d_dxf.zip](#)

English

[3D PDF](#)

3D

By downloading the CAD file I accept and agree to the [Terms and Conditions](#) of use.

Datasheets & Catalog Pages

[SWITCHES_CORE_PROGRAM_CATALOG](#)

English

[ADE_ADP_ADF_Datasheet](#)

English