

1825068-1 ✓ ACTIVE

Alcoswitch | Alcoswitch CAP

TE Internal #: 1825068-1

Switch Seals & Accessories, Pushbutton Switch Boot Seal, Green Series Push Button Switches, Round, Black, Alcoswitch CAP

[View on TE.com >](#)



Relays, Contactors & Switches > Switches > Switch Seals & Accessories



Switch Boot Accessory Type: **Pushbutton Switch Boot Seal**

Switch Boot & Accessory For Use With: **Green Series Push Button Switches**

Style: **Round**

Switch Boot & Accessory Color: **Black**

Features

Product Type Features

Product Type	Accessory
Switch Boot Accessory Type	Pushbutton Switch Boot Seal
Style	Round

Body Features

Cap Color	Black
Switch Boot & Accessory Color	Black

Dimensions

Cap Height	8 mm[.315 in] .402 in
------------	--------------------------

Operation/Application

Switch Boot & Accessory For Use With	Green Series Push Button Switches
--------------------------------------	-----------------------------------

Packaging Features

Packaging Method	Box & Carton
------------------	--------------

Other

Comment	See Drawings 1805040 and 1805041 for
---------	--------------------------------------



switches.

Product Compliance

[For compliance documentation, visit the product page on TE.com>](#)

EU RoHS Directive 2011/65/EU	Compliant
EU ELV Directive 2000/53/EC	Compliant
China RoHS 2 Directive MIIT Order No 32, 2016	No Restricted Materials Above Threshold
EU REACH Regulation (EC) No. 1907/2006	Current ECHA Candidate List: JUNE 2023 (235) Candidate List Declared Against: JUNE 2023 (235) Does not contain REACH SVHC
Halogen Content	Low Halogen - Br, Cl, F, I < 900 ppm per homogenous material. Also BFR/CFR/PVC Free
Solder Process Capability	Not applicable for solder process capability

Product Compliance Disclaimer

This information is provided based on reasonable inquiry of our suppliers and represents our current actual knowledge based on the information they provided. This information is subject to change. The part numbers that TE has identified as EU RoHS compliant have a maximum concentration of 0.1% by weight in homogenous materials for lead, hexavalent chromium, mercury, PBB, PBDE, DBP, BBP, DEHP, DIBP, and 0.01% for cadmium, or qualify for an exemption to these limits as defined in the Annexes of Directive 2011/65/EU (RoHS2). Finished electrical and electronic equipment products will be CE marked as required by Directive 2011/65/EU. Components may not be CE marked. Additionally, the part numbers that TE has identified as EU ELV compliant have a maximum concentration of 0.1% by weight in homogenous materials for lead, hexavalent chromium, and mercury, and 0.01% for cadmium, or qualify for an exemption to these limits as defined in the Annexes of Directive 2000/53/EC (ELV). Regarding the REACH Regulation, the information TE provides on SVHC in articles for this part number is based on the latest European Chemicals Agency (ECHA) 'Guidance on requirements for substances in articles' posted at this URL: <https://echa.europa.eu/guidance-documents/guidance-on-reach>

Compatible Parts

 <p>TE Part # 1825068-2 C22204 CAP RED</p>	 <p>TE Part # 1825069-1 C23004 CAP BLACK</p>	 <p>TE Part # 1571384-4 CAP, BLACK</p>	 <p>TE Part # 1571384-2 CAP, ORANGE</p>
---	---	---	--

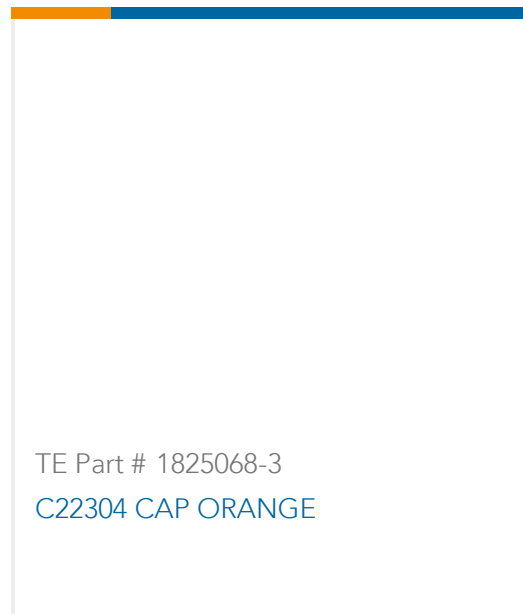
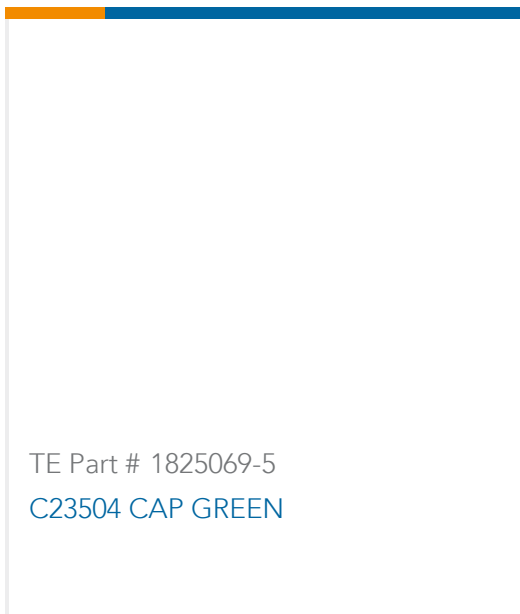
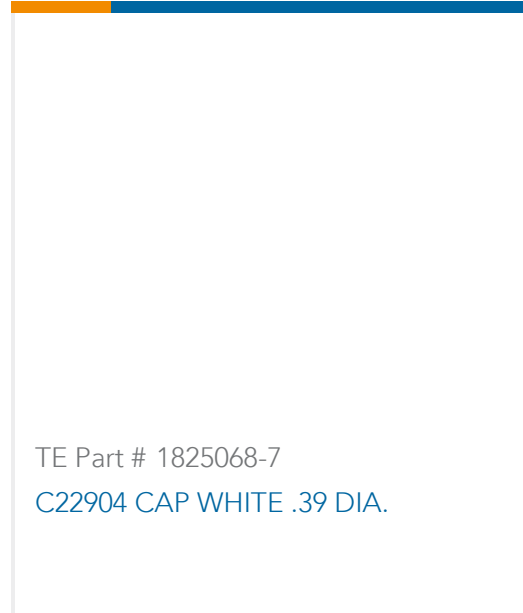

Also in the Series | Alcoswitch CAP

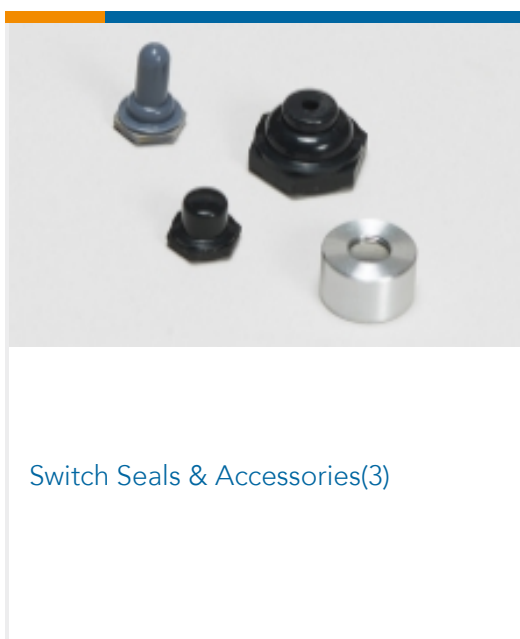

Customers Also Bought



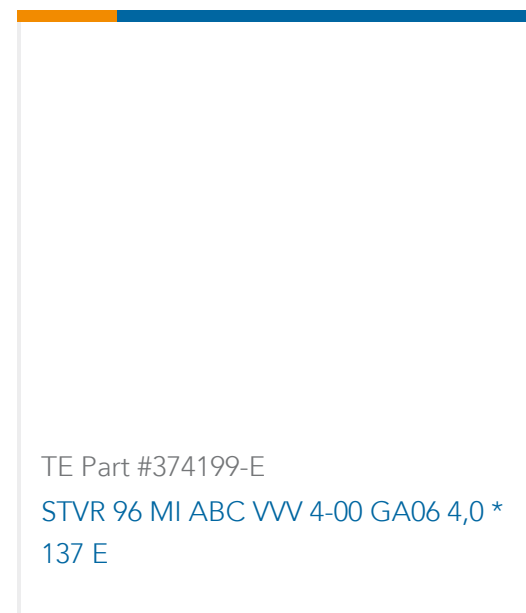
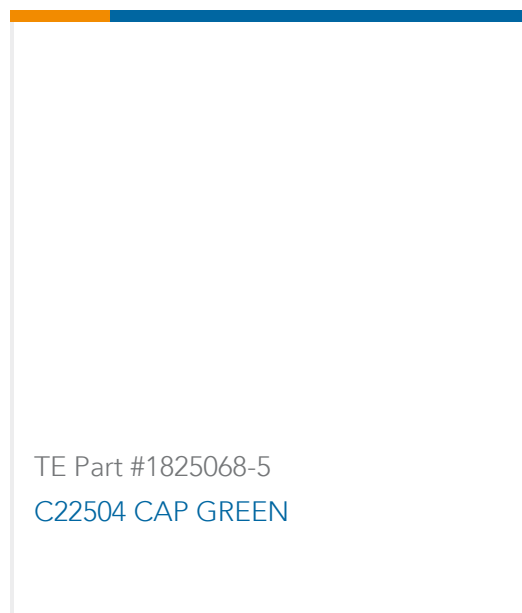
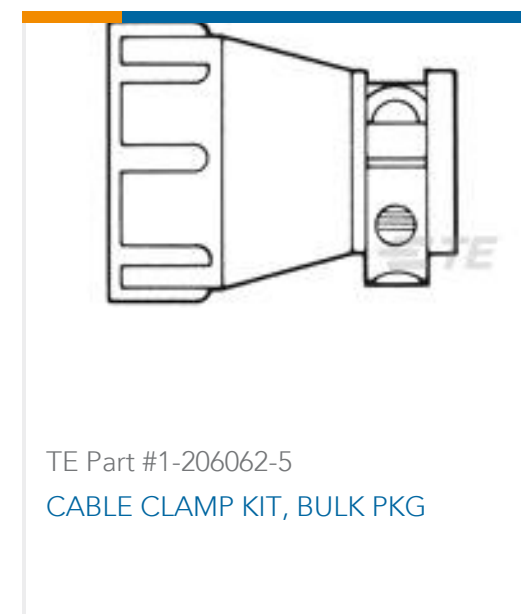

Documents

Product Drawings

C22004 CAP BLACK

English

CAD Files

Customer View Model

[ENG_CVM_CVM_1825068-1_A1.3d_igs.zip](#)

English

Customer View Model

[ENG_CVM_CVM_1825068-1_A1.3d_stp.zip](#)

English

Customer View Model

[ENG_CVM_CVM_1825068-1_A1.2d_dxf.zip](#)

English

3D PDF

3D

By downloading the CAD file I accept and agree to the [Terms and Conditions](#) of use.

Product Environmental Compliance

TE Material Declaration

English