

181270-3 ✓ ACTIVE

AMPMODU | AMPMODU IV/V

TE Internal #: 181270-3

Connector Contact, Socket, Board-to-Board, 22 – 26 AWG Wire Size, 631.52 – 256.56 CMA Wire Size, .32 – .13 mm<sup>2</sup> Wire Size, Gold, Reel, AMPMODU IV/V

[View on TE.com >](#)



Connectors > PCB Connectors > Wire-to-Board Connectors > Wire-to-Board Connector Contacts

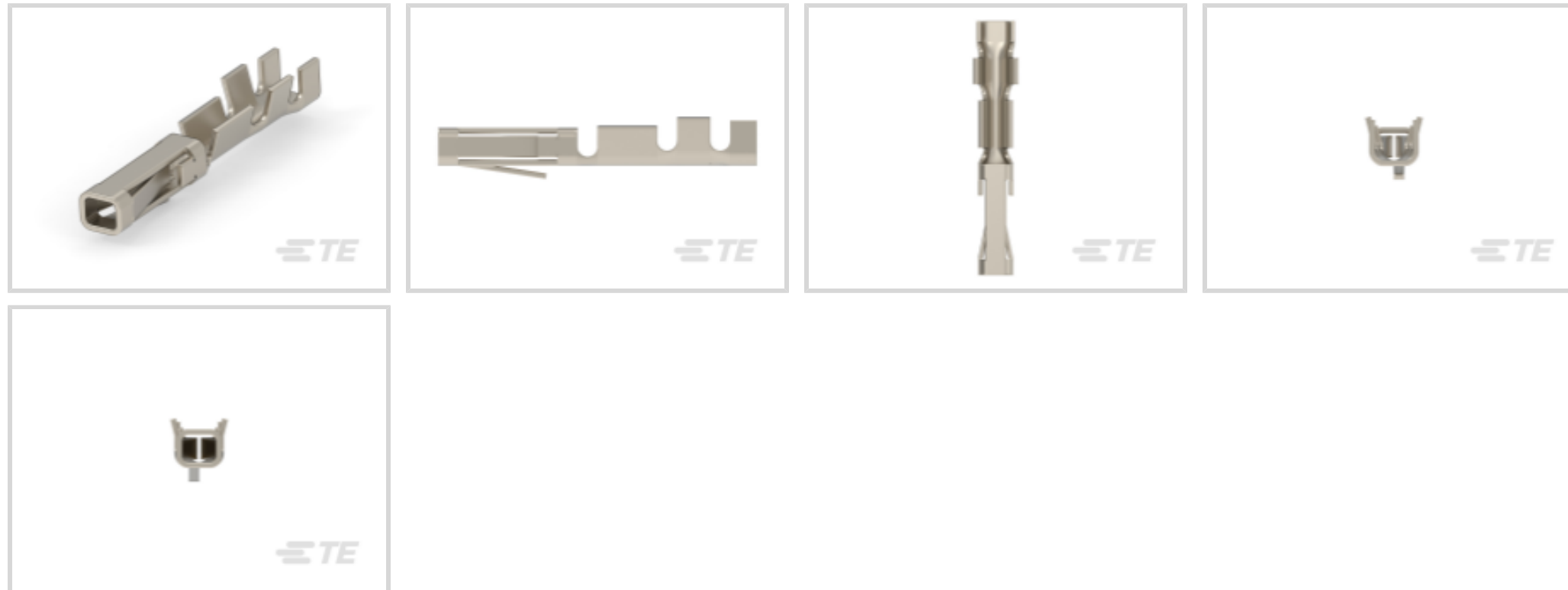

Contact Type: **Socket**

Connector System: **Board-to-Board**

Wire Size: **.32 – .13 mm<sup>2</sup>**

## Features

### Product Type Features

Applied Pressure	Standard
Connector System	Board-to-Board
Connector & Contact Terminates To	Printed Circuit Board

### Electrical Characteristics

Termination Resistance	7 mΩ
Operating Voltage	40 VAC

### Contact Features

Mating Square Post Dimension	.63 mm[.025 in]
Wire Contact Termination Area Plating Material	Gold Flash
	15 μin
Contact Base Material	Phosphor Bronze
Contact Type	Socket
Contact Mating Area Plating Material	Gold
Contact Current Rating (Max)	3 A

### Termination Features

Termination Method to Wire & Cable	Crimp
------------------------------------	-------

### Mechanical Attachment

Wire Insulation Support	With
-------------------------	------

### Dimensions

Compatible Insulation Diameter Range	.9 – 1.55 mm [.035 – .061 in]
--------------------------------------	-------------------------------

Wire Size	.32 – .13 mm <sup>2</sup>
-----------	---------------------------

### Usage Conditions

Operating Temperature Range	-40 – 80 °C [-40 – 176 °F]
-----------------------------	----------------------------

### Operation/Application

Circuit Application	Signal
---------------------	--------

### Packaging Features

Packaging Method	Reel
------------------	------

## Product Compliance

For compliance documentation, visit the product page on [TE.com](https://www.te.com)>

EU RoHS Directive 2011/65/EU	Compliant
------------------------------	-----------

EU ELV Directive 2000/53/EC	Compliant
-----------------------------	-----------

China RoHS 2 Directive MIIT Order No 32, 2016	No Restricted Materials Above Threshold
---	---

EU REACH Regulation (EC) No. 1907/2006	Current ECHA Candidate List: JUNE 2023 (235) Candidate List Declared Against: JUNE 2023 (235) Does not contain REACH SVHC
--	---













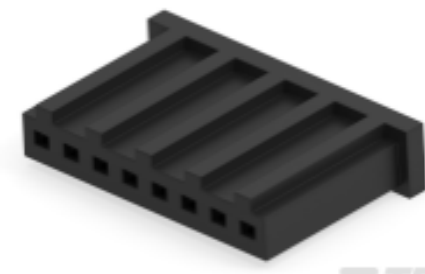
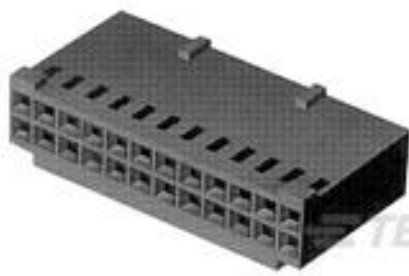
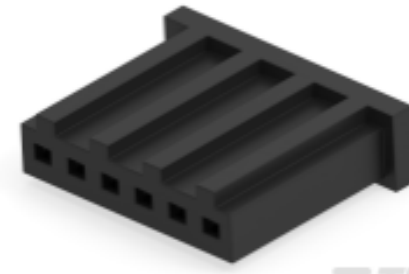

Halogen Content	Low Halogen - Br, Cl, F, I < 900 ppm per homogenous material. Also BFR/CFR/PVC Free
-----------------	---

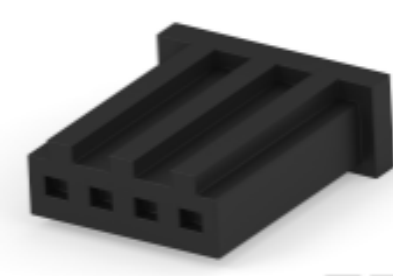
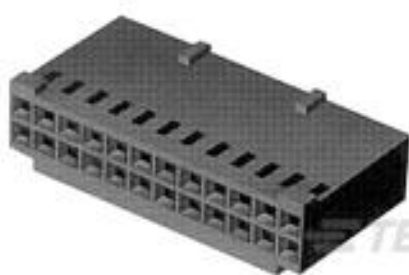
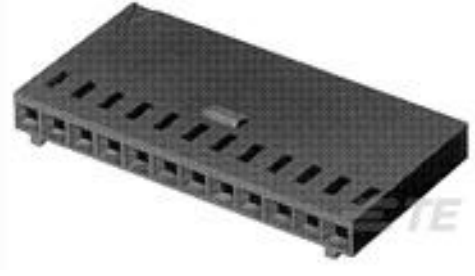
Solder Process Capability	Not applicable for solder process capability
---------------------------	--

#### Product Compliance Disclaimer

This information is provided based on reasonable inquiry of our suppliers and represents our current actual knowledge based on the information they provided. This information is subject to change. The part numbers that TE has identified as EU RoHS compliant have a maximum concentration of 0.1% by weight in homogenous materials for lead, hexavalent chromium, mercury, PBB, PBDE, DBP, BBP, DEHP, DIBP, and 0.01% for cadmium, or qualify for an exemption to these limits as defined in the Annexes of Directive 2011/65/EU (RoHS2). Finished electrical and electronic equipment products will be CE marked as required by Directive 2011/65/EU. Components may not be CE marked. Additionally, the part numbers that TE has identified as EU ELV compliant have a maximum concentration of 0.1% by weight in homogenous materials for lead, hexavalent chromium, and mercury, and 0.01% for cadmium, or qualify for an exemption to these limits as defined in the Annexes of Directive 2000/53/EC (ELV). Regarding the REACH Regulation, the information TE provides on SVHC in articles for this part number is based on the latest European Chemicals Agency (ECHA) 'Guidance on requirements for substances in articles' posted at this URL: <https://echa.europa.eu/guidance-documents/guidance-on-reach>

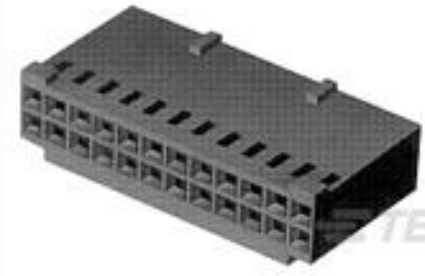
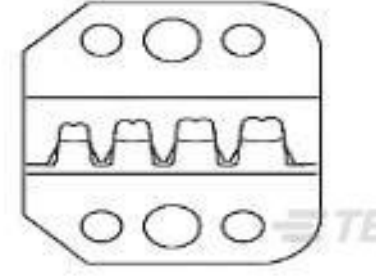
## Compatible Parts

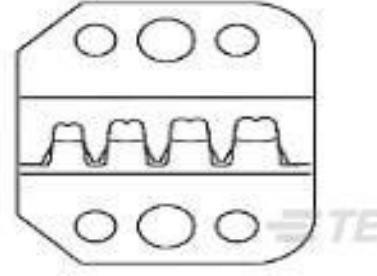
 <p>TE Part # 58535-1 PRO-CRIMPER ASSY MODU MODII</p>	 <p>TE Part # 280514 AMPMODU II REC. HSG, SINGLE ROW, 12 POS.</p>	 <p>TE Part # 280366 AMPMODU II REC. HSG DUAL ROW, 16 POS.</p>	 <p>TE Part # 280365 AMPMODU, DBL ROW, CONTACT REC</p>
 <p>TE Part # 280361 AMPMODU II REC. HSG, SINGLE ROW 8 POS</p>	 <p>TE Part # 280515 AMPMODU II REC. HSG, DUAL ROW, 24 POS.</p>	 <p>TE Part # 280360 AMPMODU II REC. HSG, SINGLE ROW 6 POS</p>	 <p>TE Part # 280513 AMPMODU II REC. HSG, DUAL ROW, 18 POS</p>
 <p>TE Part # 280359 AMPMODU II REC. HSG, SINGLE ROW, 4 POS.</p>	 <p>TE Part # 280368 AMPMODU II REC. HSG, DUAL ROW, 30 POS.</p>	 <p>TE Part # 280363 AMPMODU II REC. HSG, SINGLE ROW, 15 POS.</p>	 <p>TE Part # 284123-1 AMPMODU II REC. HSG, DUAL ROW, 10 POS.</p>
 <p>TE Part # 58654-1 PRO-CRIMP TL &amp; DIE MOD II</p>	 <p>TE Part # 280362 AMPMODU II REC. HSG, SINGLE ROW, 10 POS.</p>	 <p>TE Part # 280358 AMPMODU II REC. HSG, SINGLE ROW 2 POS</p>	 <p>TE Part # 280512 AMPMODU II REC. HSG, SINGLE ROW, 9 POS.</p>
 <p>TE Part # 281018 AMPMODU II REC. HSG, DUAL ROW, 36 POS.</p>	 <p>TE Part # 58535-2 PRO-CRIMPER ASSY MODU</p>	 <p>TE Part # 280364 AMPMODU II COSI REC. HSG, SGL ROW, 22POS</p>	 <p>TE Part # 58654-2 PRO-CRIMPER DIE SET ONLY</p>



## Also in the Series | AMPMODU IV/V



Automotive Housings(2)

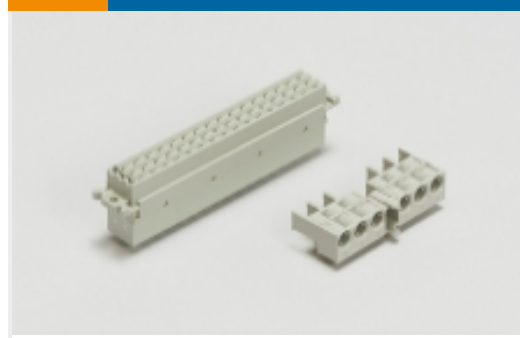

Backplane Connector Housings(1)



Board-to-Board Connector Contacts(6)



Connector Caps & Covers(18)



Connector Strain Relief(3)



Insertion & Extraction Tools(4)



PCB Connector Keying(6)



PCB Connector Mounting(1)

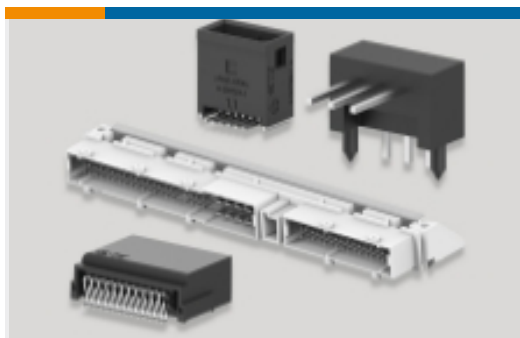

PCB Headers & Receptacles(934)

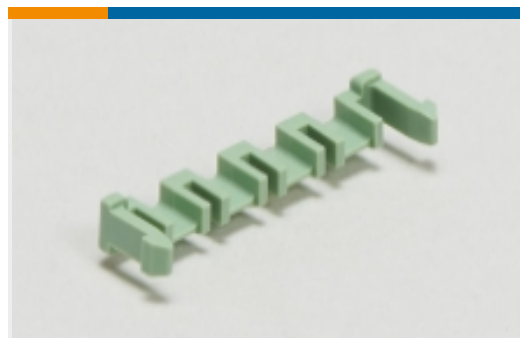

PCB Latches, Locks & Retainers(7)



Rectangular Connector Housings(5)



Standard Rectangular Connectors(8)



Wire-to-Board Connector Assemblies & Housings(447)



Wire-to-Board Connector Contacts (322)

## Customers Also Bought



TE Part #DT04-2P-EP04  
REC, 2P, GRY, N, CAP

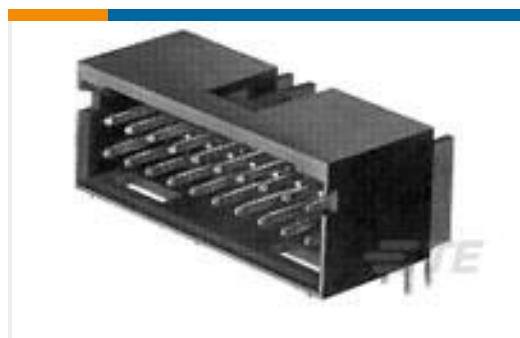

TE Part #6-102617-3  
30 MODII HDR DRRA SHRD LF



TE Part #6-534206-5  
30 MODII VRT DR CE 100/115



TE Part #CB5432-000  
XFFR-04X4



TE Part #927840-2  
SPT REC 6.3 Contact SRC Sn



TE Part #5750913-7  
68 50SR CABLE CONN KIT



TE Part #5749195-2  
68 50SR KIT,ST,UK



TE Part #1740261-2  
NECTOR S RING CLIP BLACK



TE Part #140719-2  
110 FASTON,REC.,22-18 AWG,TPBR

## Documents

### Product Drawings

#### MOD 2 BUCHSE

English

### CAD Files

#### 3D PDF

3D

#### Customer View Model

[ENG\\_CVM\\_CVM\\_181270-3\\_AN\\_c-181270-3-an.2d\\_dxf.zip](#)

English

#### Customer View Model

[ENG\\_CVM\\_CVM\\_181270-3\\_AN\\_c-181270-3-an.3d\\_igs.zip](#)

English

#### Customer View Model

[ENG\\_CVM\\_CVM\\_181270-3\\_AN\\_c-181270-3-an.3d\\_stp.zip](#)

English

By downloading the CAD file I accept and agree to the [Terms and Conditions](#) of use.

### Product Specifications

#### Application Specification

English

### Product Environmental Compliance

#### Product Compliance

English

#### Product Compliance

English

181270-3

Connector Contact, Socket, Board-to-Board, 22 – 26 AWG Wire Size, 631.52 – 256.56  
CMA Wire Size, .32 – .13 mm<sup>2</sup> Wire Size, Gold, Reel, AMPMODU IV/V

