

178022-1 ✓ ACTIVE

FASTIN-FASTON | FASTIN-FASTON 250

TE Internal #: 178022-1

Crimp Terminal Housings, Receptacle, Receptacle, 6 Position, Straight, Natural, Nylon, Contact Mating Retention, Mating Alignment, FASTIN-FASTON 250

[View on TE.com >](#)



Terminals & Splices > Terminal Housings, Insulation Sleeves & Blocks > Crimp Terminal Housings

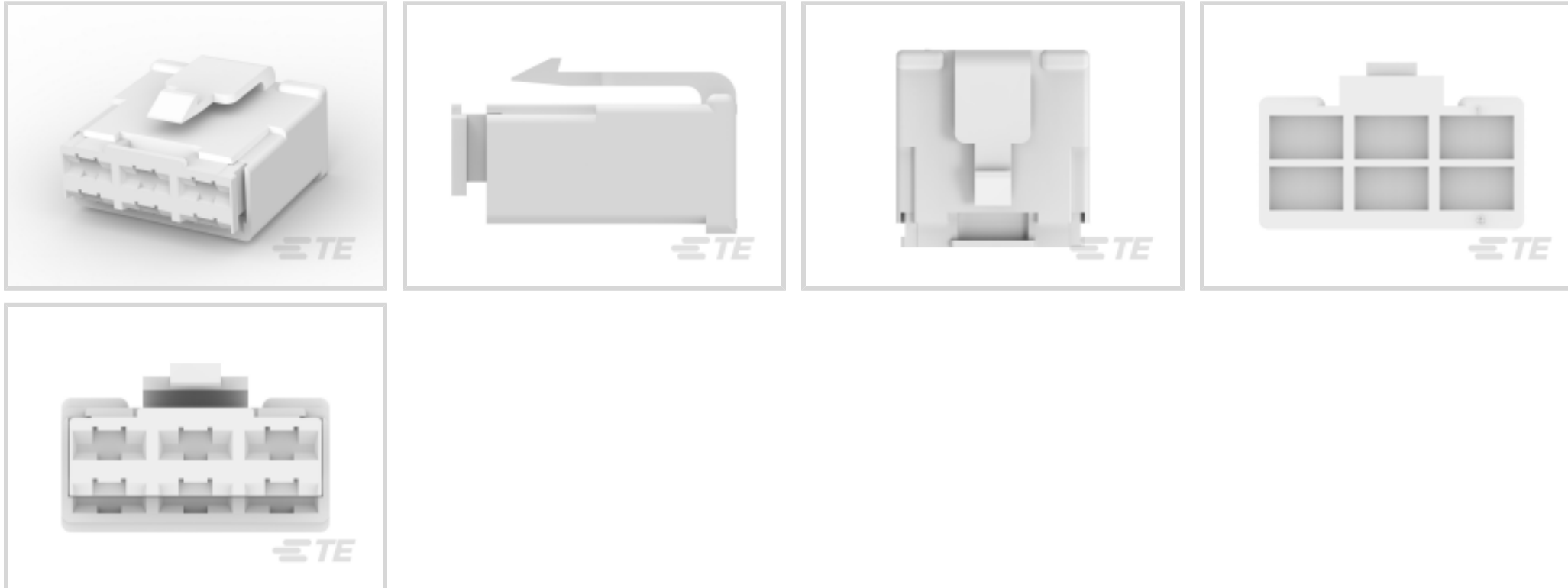

Terminal Type: **Receptacle**

Connector & Housing Type: **Receptacle**

Number of Positions: **6**

Terminal Orientation: **Straight**

Primary Product Color: **Natural**

## Features

### Product Type Features

Sealable	No
Connector & Contact Terminates To	Wire & Cable
Connector & Housing Type	Receptacle

### Configuration Features

Number of Positions	6
---------------------	---

### Body Features

Primary Product Color	Natural
-----------------------	---------

### Contact Features

Terminal Type	Receptacle
Terminal Orientation	Straight
Contact Mating Retention	With

### Mechanical Attachment

Mating Retention Type	Latch
-----------------------	-------



Mating Alignment	With
Connector Mounting Type	Cable Mount (Free-Hanging)

### Housing Features

Housing Material	Nylon
Centerline (Pitch)	5.5 mm[.216 in]

### Dimensions

Product Length	25 mm[.98 in]
----------------	---------------

### Usage Conditions

Operating Temperature Range	-40 – 120 °C[-40 – 248 °F]
-----------------------------	----------------------------

### Packaging Features

Packaging Quantity	100
--------------------	-----

## Product Compliance

[For compliance documentation, visit the product page on TE.com>](#)

EU RoHS Directive 2011/65/EU	Compliant
EU ELV Directive 2000/53/EC	Compliant
China RoHS 2 Directive MIIT Order No 32, 2016	No Restricted Materials Above Threshold
EU REACH Regulation (EC) No. 1907/2006	Current ECHA Candidate List: JUNE 2023 (235) Candidate List Declared Against: JAN 2020 (205) Does not contain REACH SVHC
Halogen Content	Low Halogen - Br, Cl, F, I < 900 ppm per homogenous material. Also BFR/CFR/PVC Free
Solder Process Capability	Not applicable for solder process capability

#### Product Compliance Disclaimer

This information is provided based on reasonable inquiry of our suppliers and represents our current actual knowledge based on the information they provided. This information is subject to change. The part numbers that TE has identified as EU RoHS compliant have a maximum concentration of 0.1% by weight in homogenous materials for lead, hexavalent chromium, mercury, PBB, PBDE, DBP, BBP, DEHP, DIBP, and 0.01% for cadmium, or qualify for an exemption to these limits as defined in the Annexes of Directive 2011/65/EU (RoHS2). Finished electrical and electronic equipment products will be CE marked as required by Directive 2011/65/EU. Components may not be CE marked. Additionally, the part numbers that TE has identified as EU ELV compliant have a maximum concentration of 0.1% by weight in homogenous materials for lead, hexavalent chromium, and mercury, and 0.01% for cadmium, or qualify for an exemption to these limits as defined in the Annexes of Directive 2000/53/EC (ELV). Regarding the REACH Regulation, the information TE provides on SVHC in articles for this part number is based on the latest European Chemicals Agency (ECHA) 'Guidance on requirements for substances in articles' posted at this URL: <https://echa.europa.eu/guidance-documents/guidance-on-reach>

## Compatible Parts



TE Part # 170258-2  
FF 250 REC 14-12AWG TPBR  
REREELING



TE Part # 170258-1  
FF 250 REC 14-12AWG BR REREELING



TE Part # 176986-1  
FF 250 PLUG HSG 1P NYLON NAT



TE Part # 178004-2  
FF 250 PLUG HSG 4P NYLON BLACK



TE Part # 176986-2  
FF 250 PLUG HSG 1P NYLON BLACK

## Also in the Series | FASTIN-FASTON 250

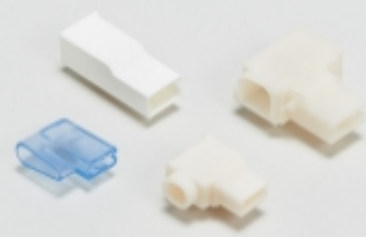

Crimp Terminal Housings(211)



Insertion & Extraction Tools(2)



PCB Terminals(2)



Quick Disconnects(254)

## Customers Also Bought



TE Part #61299-1  
SPLICE 7000-12500 .031 TPST

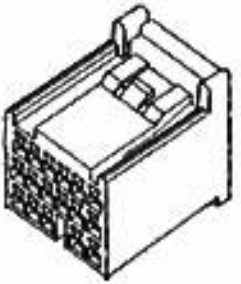

TE Part #353031-1  
040 H/D-3 PLUG HSG ASSY 31P



TE Part #178448-2  
EJ-2 DBL LOCK PLUG 2P ASSY B



TE Part #2040009-1  
0.50/1.0 SEALED WIRE COVER ASSY  
60POS

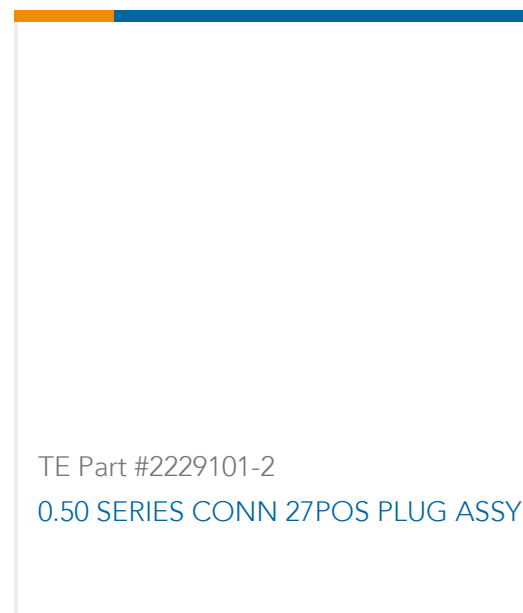
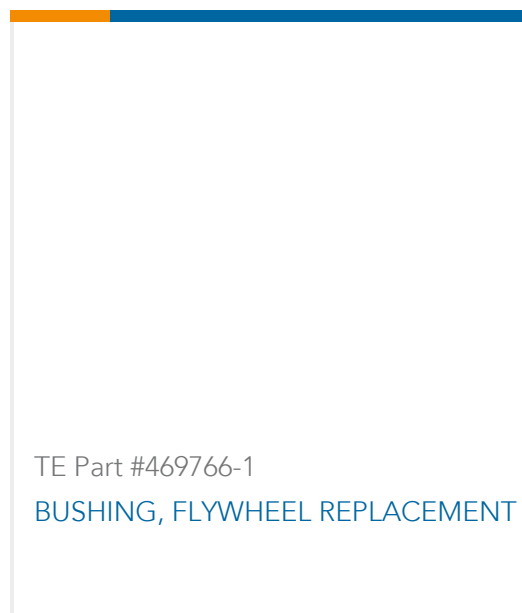

## Documents

### Product Drawings

#### FF 250 PLUG HSG DBL LOCK NAT

English

### CAD Files

#### 3D PDF

3D

#### Customer View Model

[ENG\\_CVM\\_CVM\\_178022-1\\_B.2d\\_dxf.zip](#)

English

#### Customer View Model

[ENG\\_CVM\\_CVM\\_178022-1\\_B.3d\\_igs.zip](#)

English

#### Customer View Model

[ENG\\_CVM\\_CVM\\_178022-1\\_B.3d\\_stp.zip](#)

English

By downloading the CAD file I accept and agree to the [Terms and Conditions](#) of use.

### Datasheets & Catalog Pages

#### White Paper: Nylon Discoloration

English

### Product Specifications

#### Application Specification

English