



Dynamic Series | Dynamic 3000 Series

TE Internal #: 175284-3

Connector Contact, Tab, Component-to-Wire, 28 – 24 AWG Wire Size, .08 – .24 mm² Wire Size, Gold, Reel & Box, Wire & Cable, 15 A, Dynamic 3000 Series

[View on TE.com >](#)

Connectors > PCB Connectors > Wire-to-Board Connectors > Wire-to-Board Connector Contacts >

Contact: Component To Wire; 15A, 28-14 wire size



Contact Type: **Tab**

Connector System: **Component-to-Wire**

Wire Size: **.08 – .24 mm²**

Contact Mating Area Plating Material: **Gold**

[All Contact: Component To Wire; 15A, 28-14 wire size \(91\)](#)

Features

Product Type Features

Connector System	Component-to-Wire
Connector & Contact Terminates To	Wire & Cable

Contact Features

Mating Tab Width	2 mm[.08 in]
Mating Tab Thickness	.64 mm[.025 in]
Contact Type	Tab
Contact Mating Area Plating Material	Gold
Contact Current Rating (Max)	15 A

Dimensions

Wire Size	.08 – .24 mm ²
-----------	---------------------------

Usage Conditions

Operating Temperature Range	-55 – 105 °C[-67 – 221 °F]
-----------------------------	----------------------------



Operation/Application

Circuit Application	Power & Signal
---------------------	----------------

Packaging Features

Packaging Method	Reel & Box
------------------	------------

Product Compliance

[For compliance documentation, visit the product page on TE.com>](#)

EU RoHS Directive 2011/65/EU	Compliant
EU ELV Directive 2000/53/EC	Compliant
China RoHS 2 Directive MIIT Order No 32, 2016	No Restricted Materials Above Threshold
EU REACH Regulation (EC) No. 1907/2006	Current ECHA Candidate List: JUNE 2023 (235) Candidate List Declared Against: JAN 2021 (211) Does not contain REACH SVHC
Halogen Content	Not Yet Reviewed for halogen content
Solder Process Capability	Not applicable for solder process capability

Product Compliance Disclaimer

This information is provided based on reasonable inquiry of our suppliers and represents our current actual knowledge based on the information they provided. This information is subject to change. The part numbers that TE has identified as EU RoHS compliant have a maximum concentration of 0.1% by weight in homogenous materials for lead, hexavalent chromium, mercury, PBB, PBDE, DBP, BBP, DEHP, DIBP, and 0.01% for cadmium, or qualify for an exemption to these limits as defined in the Annexes of Directive 2011/65/EU (RoHS2). Finished electrical and electronic equipment products will be CE marked as required by Directive 2011/65/EU. Components may not be CE marked. Additionally, the part numbers that TE has identified as EU ELV compliant have a maximum concentration of 0.1% by weight in homogenous materials for lead, hexavalent chromium, and mercury, and 0.01% for cadmium, or qualify for an exemption to these limits as defined in the Annexes of Directive 2000/53/EC (ELV). Regarding the REACH Regulation, the information TE provides on SVHC in articles for this part number is based on the latest European Chemicals Agency (ECHA) 'Guidance on requirements for substances in articles' posted at this URL: <https://echa.europa.eu/guidance-documents/guidance-on-reach>

Compatible Parts



TE Part # CAT-D9934-A75B
Receptacle and Tab Housing: 5.08 mm Pitch, 250-600V



TE Part # CAT-D9934-A75C
Receptacle and Tab Housing: 5.08 mm pitch, 600V



TE Part # CAT-D9934-A75A
Receptacle and Tab Housing: 3.81 mm pitch, 250V



TE Part # 2305570-1
Strip Terminal Cutter-Side Feed-No Crimp



Also in the Series | **Dynamic 3000 Series**

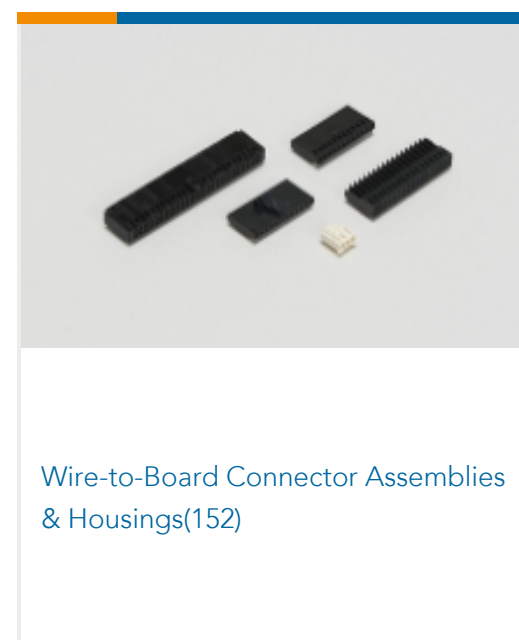
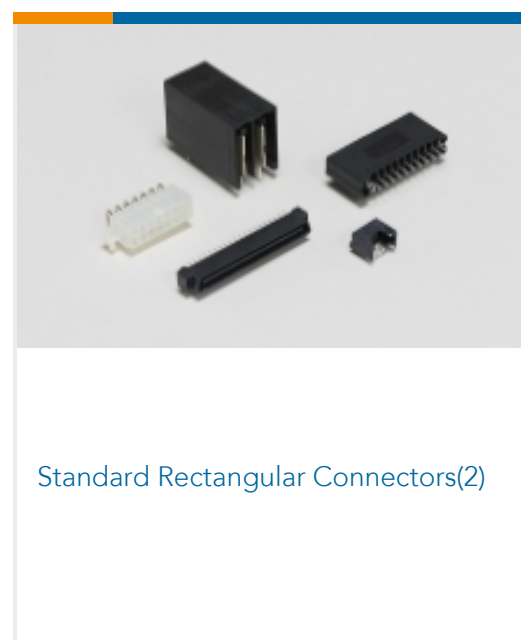
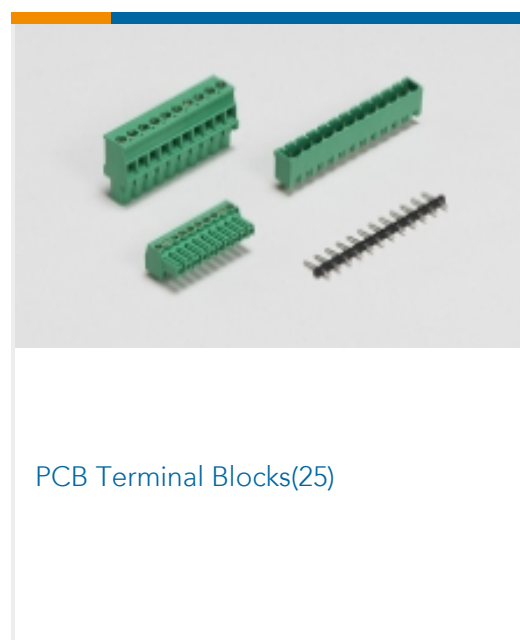
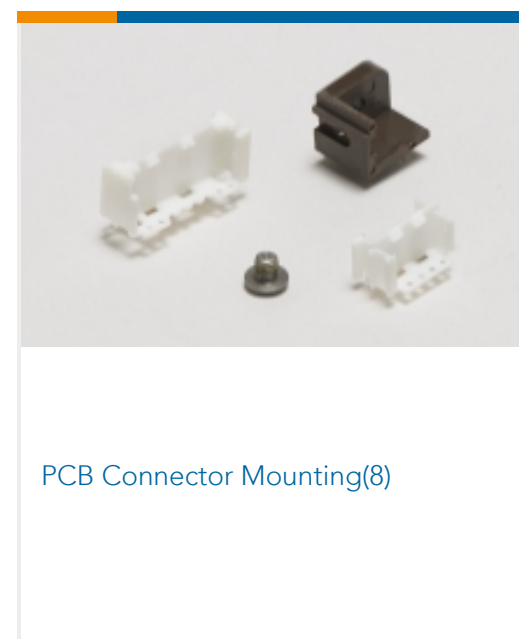
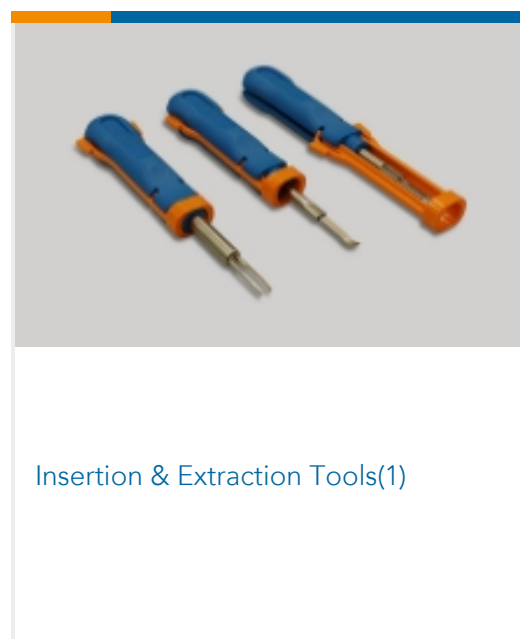
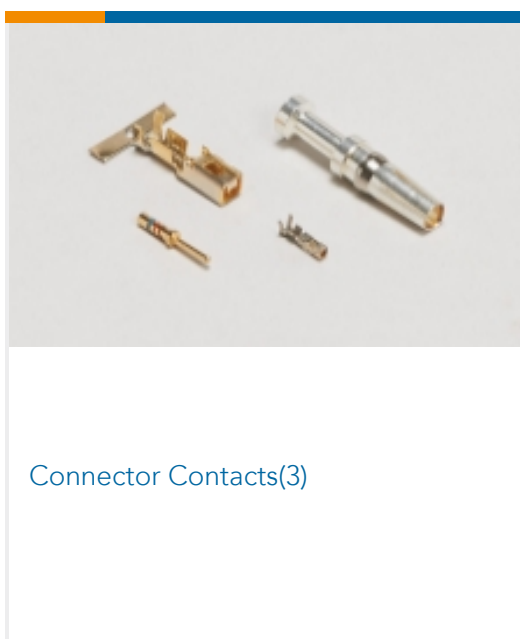



Wire-to-Board Connector Contacts(91)

Customers Also Bought

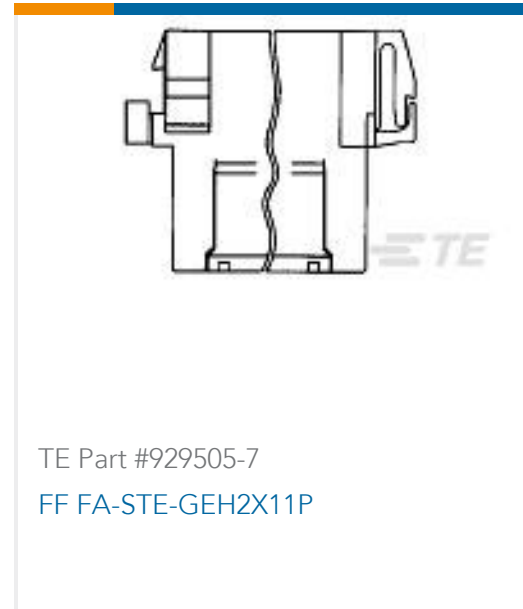
TE Part #WB-51SAL
DEUTSCH DRB WedgelocksTE Part #929505-7
FF FA-STE-GEH2X11PTE Part #2-179552-4
DYNAMIC D-3200S TAB HSG 4P K/YTE Part #280223-2
FASTON 375 ASY REC 4-6MM2 0.5X27.0 TPBRTE Part #4-1437624-6
PKES120B1/4=KNOB PLSTC FLUTEDTE Part #1394050-2
COVER F.21P REC-HSGTE Part #173974-2
PL 187 (4.8 MM) HOUSING RECEPTACLETE Part #364201-E
SRCBUG A 2,54 2 2 CSI 165 E1 ADV TRAY J

Documents

Product Drawings

[DYNAMIC D-3 TAB CONT. S AU 0.76](#)

English

CAD Files

[3D PDF](#)

3D

Customer View Model

[ENG_CVM_CVM_175284-3_E.2d_dxf.zip](#)

English

Customer View Model

[ENG_CVM_CVM_175284-3_E.3d_igs.zip](#)

English

Customer View Model

[ENG_CVM_CVM_175284-3_E.3d_stp.zip](#)

English

By downloading the CAD file I accept and agree to the [Terms and Conditions](#) of use.



Datasheets & Catalog Pages

[1-1773732-4_DYNAMIC_SERIES_CATALOG_ENGLISH](#)

Japanese

[1-1773732-4_DYNAMIC_SERIES_CATALOG_ENGLISH](#)

English

Product Specifications

[Application Specification](#)

English

Instruction Sheets

[Instruction Sheet \(non U.S.\)](#)

English

Agency Approvals

[TUV Certificate](#)

English