



AMP Universal Power

TE Internal #: 175152-2

Power Contacts, Contact, 300 VAC / 50 VAC, Tin, 20 – 16 AWG

Wire Size, .5 – 1.42 mm² Wire Size, Wire & Cable, Crimp, Power,

AMP Universal Power

[View on TE.com >](#)

Connectors > Power Connectors > Power Contacts

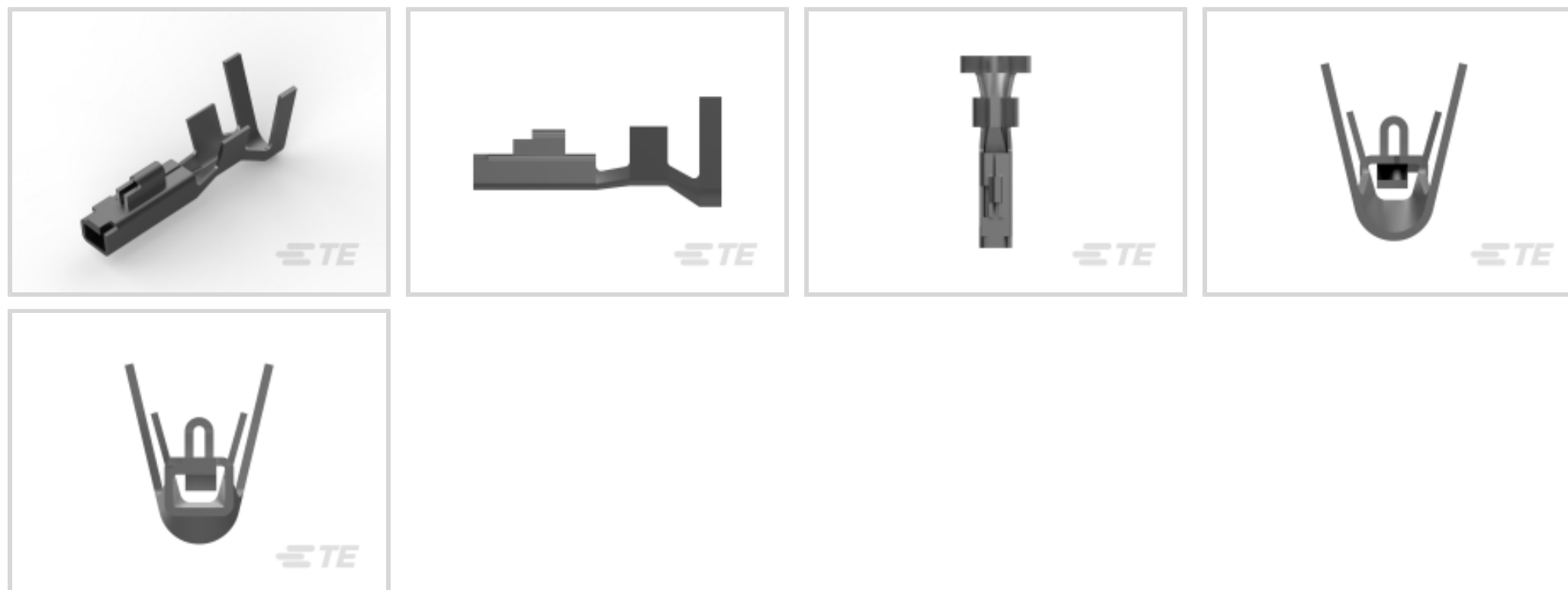

Power Contact Type: **Contact**

Operating Voltage: **50 VAC, 300 VAC**

Contact Mating Area Plating Material: **Tin**

Wire Size: **.5 – 1.42 mm²**

Features

Product Type Features

Power Contact Type	Contact
Connector & Contact Terminates To	Wire & Cable

Electrical Characteristics

Operating Voltage	50 VAC, 300 VAC
-------------------	-----------------

Contact Features

Contact Mating Area Plating Material	Tin
Contact Current Rating (Max)	12 A
Contact Type	Receptacle
Contact Retention Within Housing	With
Mating Tab Width	1.2 mm[.047 in]
Mating Tab Thickness	.64 mm[.025 in]
Contact Base Material	Brass
Contact Mating Area Plating Material Thickness	.8 μm[31.49 μin]
Wire Contact Termination Area Plating Thickness	.8 μm[31.49 μin]
Wire Contact Termination Area Plating Material	Pre-Tin



Wire Contact Termination Area Plating Material Finish	Matte
Contact Orientation	Straight

Termination Features

Termination Method to Wire & Cable	Crimp
------------------------------------	-------

Mechanical Attachment

Wire Insulation Support	With
-------------------------	------

Dimensions

Wire Size	.5 – 1.42 mm ²
Compatible Insulation Diameter Range	1.7 – 3.3 mm [.067 – .13 in]

Usage Conditions

Operating Temperature Range	-30 – 105 °C [-22 – 221 °F]
-----------------------------	-----------------------------

Operation/Application

Circuit Application	Power
---------------------	-------

Packaging Features

Packaging Quantity	4000
Packaging Method	Reel

Product Compliance

[For compliance documentation, visit the product page on TE.com>](#)

EU RoHS Directive 2011/65/EU	Compliant
EU ELV Directive 2000/53/EC	Compliant
China RoHS 2 Directive MIIT Order No 32, 2016	No Restricted Materials Above Threshold
EU REACH Regulation (EC) No. 1907/2006	Current ECHA Candidate List: JUNE 2023 (235) Candidate List Declared Against: JUNE 2023 (235) Does not contain REACH SVHC
Halogen Content	Low Halogen - Br, Cl, F, I < 900 ppm per homogenous material. Also BFR/CFR/PVC Free
Solder Process Capability	Not applicable for solder process capability

Product Compliance Disclaimer

This information is provided based on reasonable inquiry of our suppliers and represents our current actual knowledge based on the information they provided. This information is subject to change. The part numbers that TE has identified as

EU RoHS compliant have a maximum concentration of 0.1% by weight in homogenous materials for lead, hexavalent chromium, mercury, PBB, PBDE, DBP, BBP, DEHP, DIBP, and 0.01% for cadmium, or qualify for an exemption to these limits as defined in the Annexes of Directive 2011/65/EU (RoHS2). Finished electrical and electronic equipment products will be CE marked as required by Directive 2011/65/EU. Components may not be CE marked. Additionally, the part numbers that TE has identified as EU ELV compliant have a maximum concentration of 0.1% by weight in homogenous materials for lead, hexavalent chromium, and mercury, and 0.01% for cadmium, or qualify for an exemption to these limits as defined in the Annexes of Directive 2000/53/EC (ELV). Regarding the REACH Regulation, the information TE provides on SVHC in articles for this part number is based on the latest European Chemicals Agency (ECHA) 'Guidance on requirements for substances in articles' posted at this URL: <https://echa.europa.eu/guidance-documents/guidance-on-reach>

Compatible Parts



TE Part # 176280-1
UNIV POWER PLUG HSG 18P F/H



TE Part # 176280-9
UNIV POWER PLUG HSG 18P F/H



TE Part # 176275-1
UNIV POWER PLUG HSG 8P F/H



TE Part # 176276-1
AMP UNIVERSAL POWER PLUG 9P



TE Part # 176278-9
UNIV POWER PLUG HSG 12P F/H



TE Part # 178481-1
UP 3.96 4P PLUG HSG NATRL



TE Part # 178483-1
UP 3.96 6P PLUG HSG NATRL



TE Part # 178482-1
UP 3.96 5P PLUG HSG NATRL



TE Part # 178125-1
U/POWER PLUG HSG 2P 7.92M/M



TE Part # 176273-1
AMP UNIVERSAL POWR PLUG 4P



TE Part # 176272-1
AMP UNIVERSAL POWER PLUG 3P



TE Part # 176270-1
UNIV POWER PLUG HSG 1P F/H

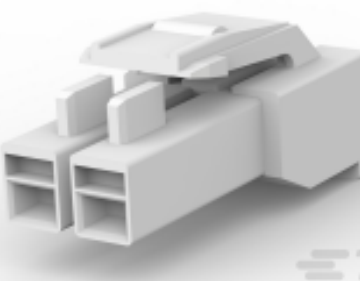

TE Part # 176271-1
AMP UNIVERSAL POWER PLUG 2P



TE Part # 178125-4
U/POWER PLUG HSG 2P 7.29MM



TE Part # 176279-1
UNIV POWER PLUG HSG 15P F/H



TE Part # 176279-9
UNIV POWER PLUG HSG 15P F/H

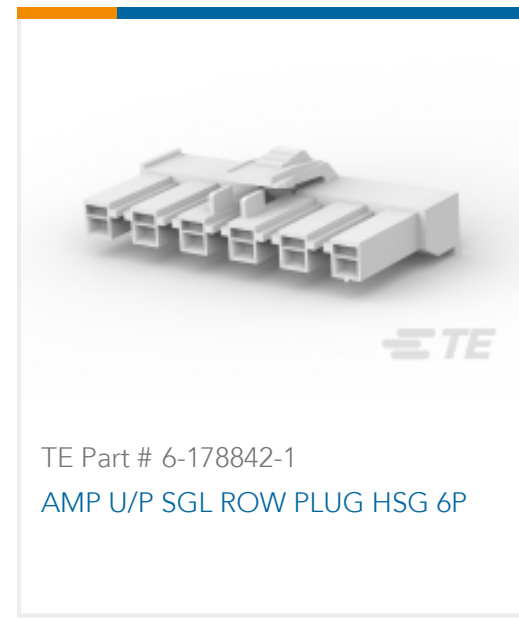
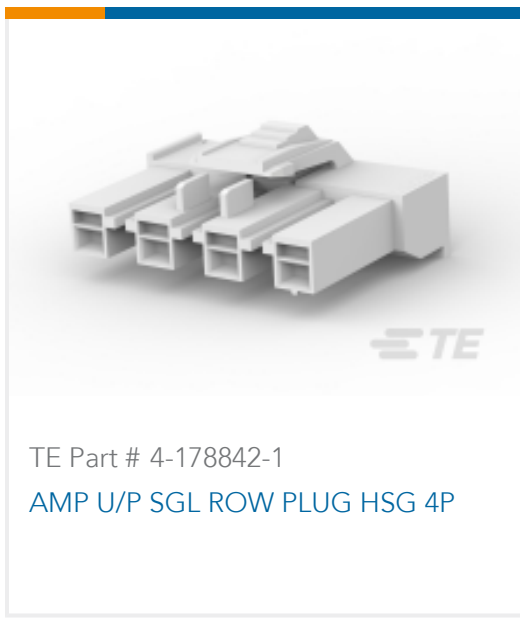

Also in the Series | AMP Universal Power

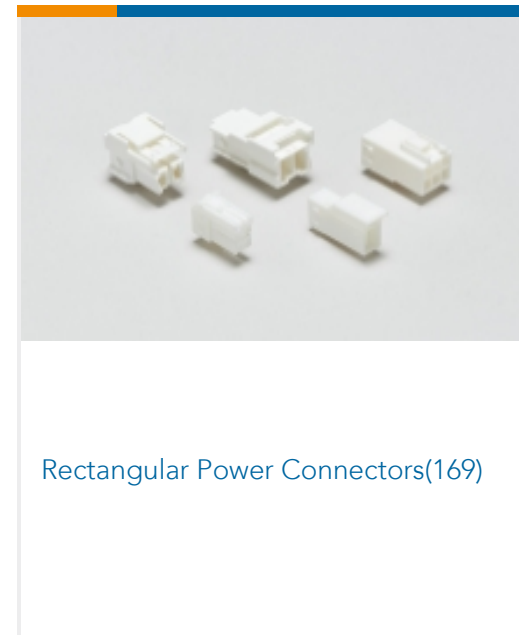
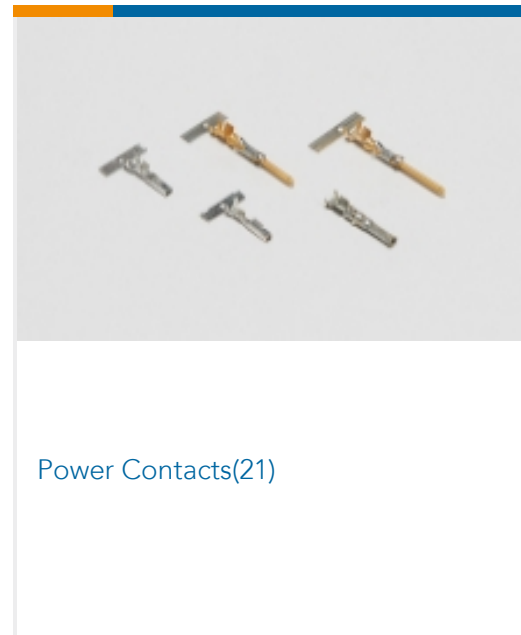
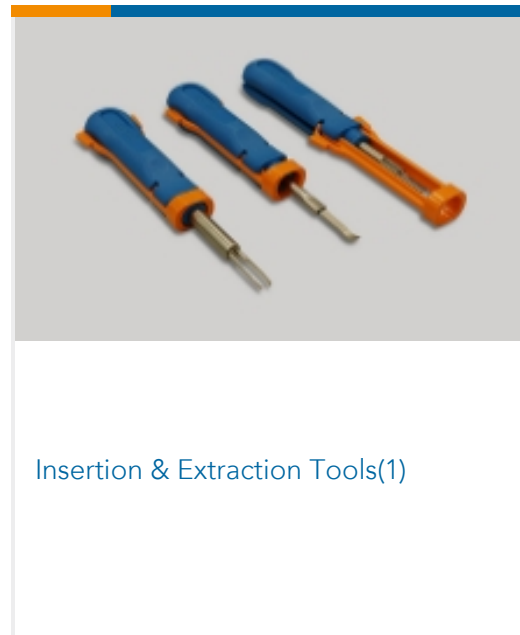
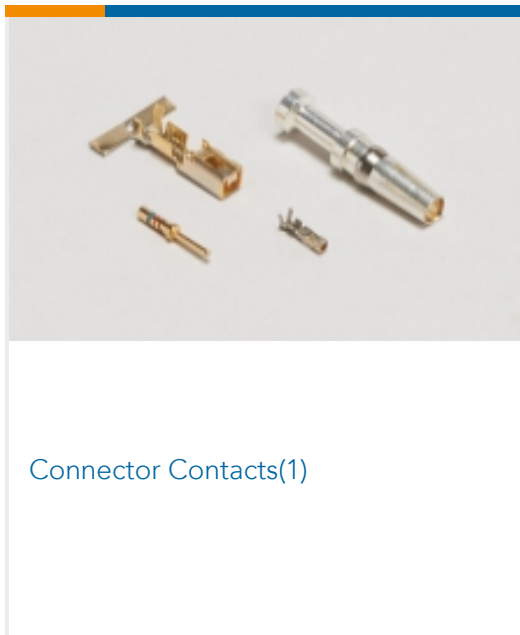

Customers Also Bought

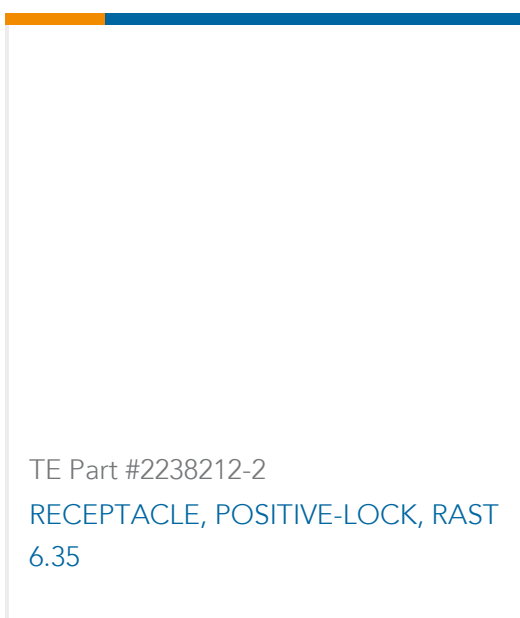
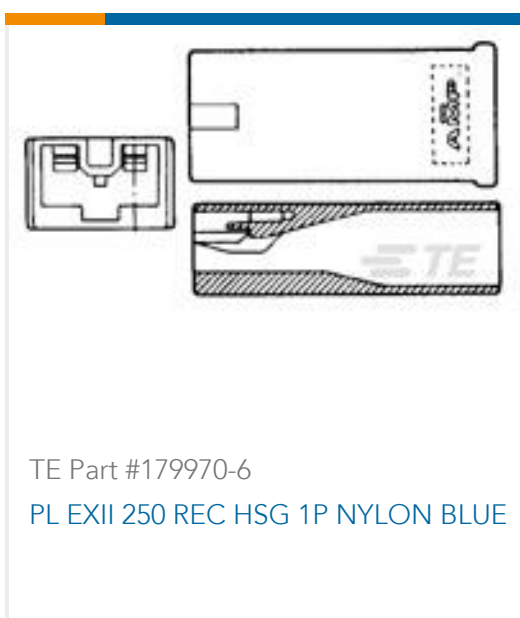
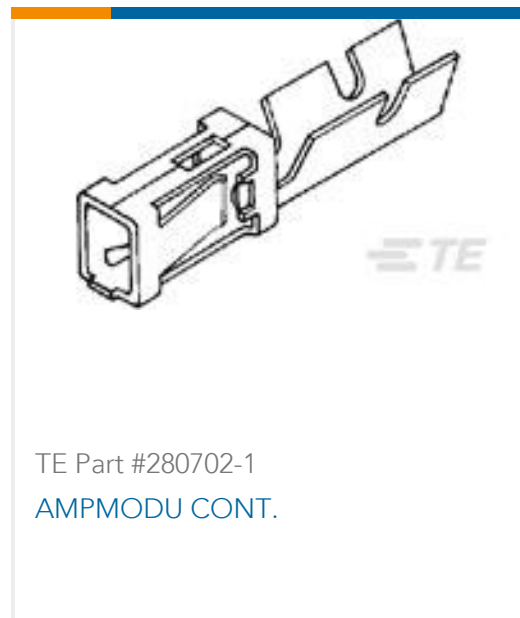



Documents

Product Drawings

[AMP UNIVE. POWER CONN REC CONT](#)

English

CAD Files

[3D PDF](#)

3D

Customer View Model

[ENG_CVM_CVM_175152-2_R.2d_dxf.zip](#)

English

Customer View Model

[ENG_CVM_CVM_175152-2_R.3d_igs.zip](#)

English

Customer View Model

[ENG_CVM_CVM_175152-2_R.3d_stp.zip](#)

English

[3D PDF](#)

English

Customer View Model

[ENG_CVM_175152-2_E.3d_igs.zip](#)

English

Customer View Model

[ENG_CVM_175152-2_E.3d_stp.zip](#)

English

Customer View Model

[ENG_CVM_175152-2_E.2d_dxf.zip](#)

English

By downloading the CAD file I accept and agree to the [Terms and Conditions](#) of use.

Product Specifications

[Application Specification](#)

English

[APPLICATION SPECIFICATION AMP UNIVERSAL POWER CONTACT, CRIMPING OF](#)

English

Product Environmental Compliance

[MD_175152-2_12182017146_dmtec](#)

English

[MD_175152-2_12182017146_dmtec](#)

English

Instruction Sheets

[Extraction Tool for UP\(913923-1\)](#)

English



[Instruction Sheet \(non U.S.\)](#)

English

[AMP UNIVERSAL POWER CONNECTOR SERIES](#)

English

[Instruction Sheet \(non U.S.\)](#)

English

[Hand Tool, PN 914181-1, Universal Power Contact \(Was IS-505J\)](#)

Japanese

[Instruction Sheet \(non U.S.\)](#)

English