

175030-1 ✓ ACTIVE

AMP | Multilock Connector System

TE Internal #: 175030-1

Automotive Terminals, Tab, Mating Tab Width 1.8 mm [.071 in], Tab Thickness .64 mm [.025 in], 20 – 16 AWG Wire Size, Multilock Connector System

[View on TE.com >](#)



Terminals & Splices > Automotive Terminals > MULTILOCK, RECEPTACLE AND TAB



Terminal Type: **Tab**

Mating Tab Width: **1.8 mm [.071 in]**

Mating Tab Thickness: **.64 mm [.025 in]**

Terminal Transmits: **0 – 24 A (Low Power)**

Wire Size: **20 – 16 AWG**

[All MULTILOCK, RECEPTACLE AND TAB \(136\)](#)

Features

Product Type Features

Sealable	No
Primary Locking Feature	Clean Body

Contact Features

Contact Size	1.8mm
Contact Fabrication	Stamped & Formed
Wire Contact Termination Area Plating Material	Tin
Typical Current Rating	14 A
Crimp Type	F-Crimp
Terminal Type	Tab
Mating Tab Width	1.8 mm[.071 in]
Mating Tab Thickness	.64 mm[.025 in]
Interface Plating	Tin (Sn)

Termination Features

Termination Method to Wire & Cable	Crimp
Product Terminates To	Wire

Dimensions



Compatible Insulation Diameter Range	2 – 2.6 mm [.079 – .102 in]
Wire Size	.5 – 1.25 mm ²
Wire Size Search	16 AWG, 17 AWG, 18 AWG, 19 AWG, 20 AWG

Usage Conditions

Insulation Option	Uninsulated
Operating Temperature (Max)	80 °C, 85 °C, 90 °C, 100 °C, 105 °C [176 °F][185 °F][194 °F][212 °F][221 °F]
Operating Temperature Range	-30 – 105 °C [-22 – 221 °F]

Packaging Features

Packaging Quantity	1000
Packaging Method	Bag

Other

Terminal Transmits	0 – 24 A (Low Power)
--------------------	----------------------

Product Compliance

[For compliance documentation, visit the product page on TE.com>](#)

EU RoHS Directive 2011/65/EU	Compliant
EU ELV Directive 2000/53/EC	Compliant
China RoHS 2 Directive MIIT Order No 32, 2016	No Restricted Materials Above Threshold
EU REACH Regulation (EC) No. 1907/2006	Current ECHA Candidate List: JUNE 2023 (235) Candidate List Declared Against: JUNE 2023 (235) Does not contain REACH SVHC
Halogen Content	Low Halogen - Br, Cl, F, I < 900 ppm per homogenous material. Also BFR/CFR/PVC Free
Solder Process Capability	Not applicable for solder process capability

Product Compliance Disclaimer

This information is provided based on reasonable inquiry of our suppliers and represents our current actual knowledge based on the information they provided. This information is subject to change. The part numbers that TE has identified as EU RoHS compliant have a maximum concentration of 0.1% by weight in homogenous materials for lead, hexavalent chromium, mercury, PBB, PBDE, DBP, BBP, DEHP, DIBP, and 0.01% for cadmium, or qualify for an exemption to these limits as defined in the Annexes of Directive 2011/65/EU (RoHS2). Finished electrical and electronic equipment products will be CE marked as required by Directive 2011/65/EU. Components may not be CE marked. Additionally, the part numbers that TE has identified as EU ELV compliant have a maximum concentration of 0.1% by weight in homogenous materials for lead, hexavalent chromium, and mercury, and 0.01% for cadmium, or qualify for an exemption to these limits as defined in the Annexes of Directive 2000/53/EC (ELV). Regarding the REACH Regulation, the information TE provides on SVHC in articles for this part number is based on the latest European Chemicals Agency (ECHA) 'Guidance on

requirements for substances in articles' posted at this URL: <https://echa.europa.eu/guidance-documents/guidance-on-reach>

Compatible Parts



TE Part # 173632-1
REC CONTAC. (POWER) AWG#14



TE Part # CAT-M9194-CH8172
MULTILOCK, CONNECTOR HOUSING



TE Part # 91573-1
CCII 070 SERIES REC TAB 20-16 ASSY



TE Part # 755430-2
EXT, TOOL ASSY



TE Part # 58521-1
PRO-CRIMPER II

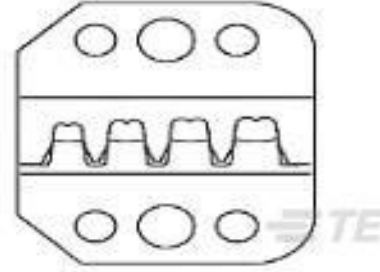

TE Part # 58521-2
PRO-CRIMPER DIE

Also in the Series | Multilock Connector System



Automotive Connector Caps & Covers
(17)

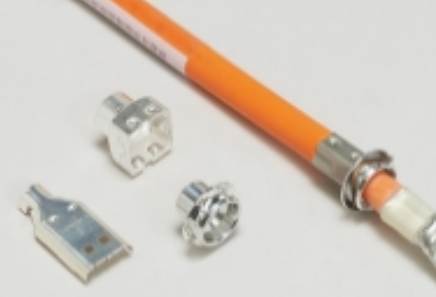

Automotive Connector EMC Shielding
(1)



Automotive Connector Locks & Position Assurance(2)



Automotive Housings(603)

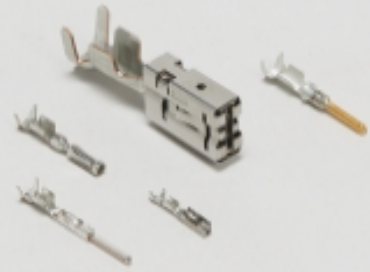

Automotive Terminals(141)



Connector Seals & Cavity Plugs(2)



Insertion & Extraction Tools(6)



Other Automotive Connector Accessories(14)



PCB Headers & Receptacles(142)

Customers Also Bought



TE Part #1-1827581-3
DYNAMIC 1500T HDR ASSY V 9P X
BLACK GOLD



TE Part #316517-2
DYNAMIC 3500 HDR ASSY 20P V



TE Part #2-917338-2
DYNAMIC 3200 VERTI. HDR ASY 4P

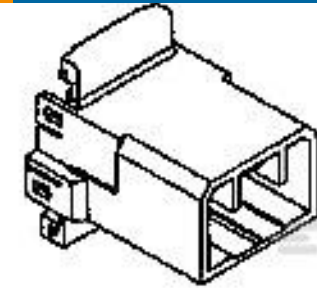

TE Part #174933-1
070 MLC W-W CAP HSG 12P

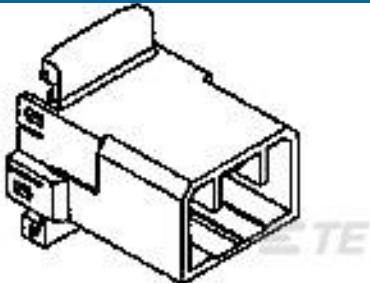

TE Part #174935-1
070 MLC W-W CAP HSG 18P

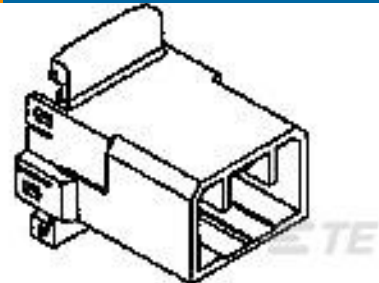

TE Part #174931-1
070 MLC W-W CAP HSG 8P NATURAL

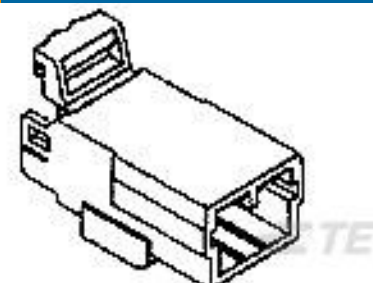

TE Part #174928-1
070 MLC W-W CAP HSG 3P NATURAL

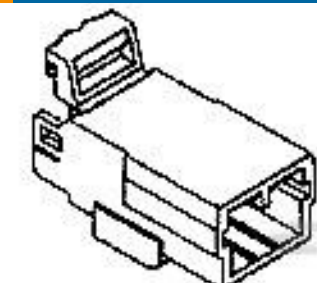

TE Part #174929-1
070 MLC W-W CAP HSG 4P NATURAL

TE Part #2337037-2
V23074A2002A403-SZ-TRAY

Documents

Product Drawings

[070 TAB CONTACT L.P 20-16](#)

Japanese

CAD Files

[3D PDF](#)

[3D](#)

[Customer View Model](#)

[ENG_CVM_CVM_175030-1_B.2d_dxf.zip](#)



English

Customer View Model

[ENG_CVM_CVM_175030-1_B.3d_igs.zip](#)

English

Customer View Model

[ENG_CVM_CVM_175030-1_B.3d_stp.zip](#)

English

Customer View Model

[ENG_CVM_175030-1_E1.3d_igs.zip](#)

English

Customer View Model

[ENG_CVM_175030-1_E1.3d_stp.zip](#)

English

Customer View Model

[ENG_CVM_175030-1_E1.2d_dxf.zip](#)

English

3D PDF

English

By downloading the CAD file I accept and agree to the [Terms and Conditions](#) of use.

Datasheets & Catalog Pages

[MULTILOCK Connector System](#)

English

Product Specifications

[Application Specification](#)

English

Instruction Sheets

[Instruction Sheet \(non U.S.\)](#)

English

[AMP Extraction Tool P/N 755430-2 for Extraction 070 Series Cont.](#)

English