



Positive Lock | Mark II, Positive Lock 250

TE Internal #: 1742354-1

Quick Disconnects, Receptacle, 18 – 16 AWG Wire Size, .82 – 1.31 mm² Wire Size, Mating Tab Width 6.35 mm [.25 in], Straight, Brass, Positive Lock 250

[View on TE.com >](#)

Terminals & Splices > Quick Disconnects

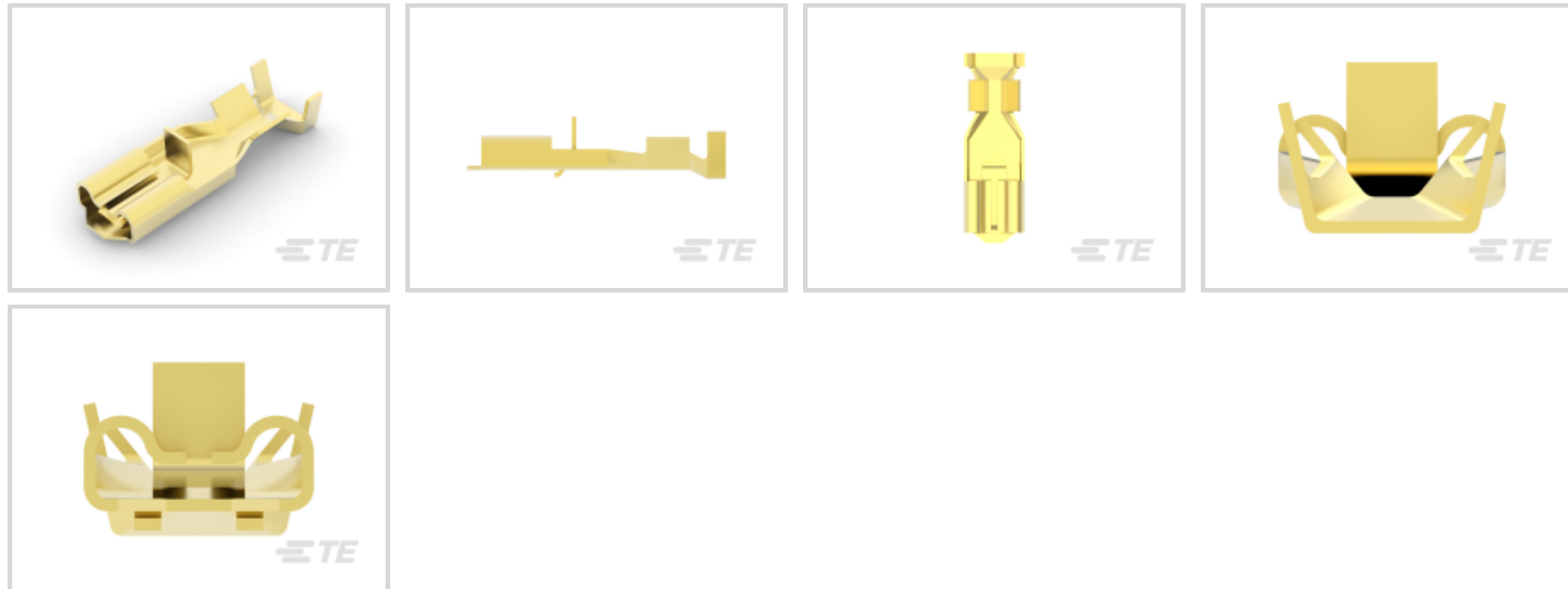

Quick Disconnect Terminal Type: **Receptacle**

Wire Size: .82 – 1.31 mm²

Mating Tab Width: 6.35 mm [.25 in]

Mating Tab Thickness: .81 mm [.032 in]

Features

Product Type Features

Insertion Force	Low
-----------------	-----

Configuration Features

Connection Capacity	Single
Compatible With Wire & Cable Type	Discrete Wire

Contact Features

Quick Disconnect Terminal Type	Receptacle
Mating Tab Width	6.35 mm [.25 in]
Mating Tab Thickness	.81 mm [.032 in]
Terminal Orientation	Straight
Contact Base Material	Brass
Terminal Plating Material	Unplated
Crimp Type	F-Crimp
Barrel Type	Open

Termination Features

--	--



Product Terminates To	Wire & Cable
-----------------------	--------------

Mechanical Attachment

Extraction Force	7 – 100 Newton
------------------	----------------

Wire Insulation Support	With
-------------------------	------

Mating Retention Type	Dimple
-----------------------	--------

Dimensions

Terminal Material Thickness	.41 mm[.016 in]
-----------------------------	-----------------

Product Length	22.5 mm[.886 in]
----------------	------------------

Compatible Insulation Diameter Range	2.67 – 5.33 mm[.105 – .21 in]
--------------------------------------	-------------------------------

Wire Size	.82 – 1.31 mm ²
-----------	----------------------------

Usage Conditions

Insulation Option	Uninsulated
-------------------	-------------

Operating Temperature Range	-40 – 110 °C[-40 – 230 °F]
-----------------------------	----------------------------

Industry Standards

Agency/Standard	UL
-----------------	----

Packaging Features

Packaging Quantity	6000
--------------------	------

Packaging Method	Strip/Reel
------------------	------------

Product Compliance

[For compliance documentation, visit the product page on TE.com>](#)

EU RoHS Directive 2011/65/EU	Compliant
------------------------------	-----------

EU ELV Directive 2000/53/EC	Compliant
-----------------------------	-----------

China RoHS 2 Directive MIIT Order No 32, 2016	No Restricted Materials Above Threshold
---	---

EU REACH Regulation (EC) No. 1907/2006	Current ECHA Candidate List: JUNE 2023 (235) Candidate List Declared Against: JUNE 2023 (235) Does not contain REACH SVHC
--	---

Halogen Content	Low Halogen - Br, Cl, F, I < 900 ppm per homogenous material. Also BFR/CFR/PVC Free
-----------------	---

Solder Process Capability	Not applicable for solder process capability
---------------------------	--

Product Compliance Disclaimer

This information is provided based on reasonable inquiry of our suppliers and represents our current actual knowledge based on the information they provided. This information is subject to change. The part numbers that TE has identified as EU RoHS compliant have a maximum concentration of 0.1% by weight in homogenous materials for lead, hexavalent chromium, mercury, PBB, PBDE, DBP, BBP, DEHP, DIBP, and 0.01% for cadmium, or qualify for an exemption to these limits as defined in the Annexes of Directive 2011/65/EU (RoHS2). Finished electrical and electronic equipment products will be CE marked as required by Directive 2011/65/EU. Components may not be CE marked. Additionally, the part numbers that TE has identified as EU ELV compliant have a maximum concentration of 0.1% by weight in homogenous materials for lead, hexavalent chromium, and mercury, and 0.01% for cadmium, or qualify for an exemption to these limits as defined in the Annexes of Directive 2000/53/EC (ELV). Regarding the REACH Regulation, the information TE provides on SVHC in articles for this part number is based on the latest European Chemicals Agency (ECHA) 'Guidance on requirements for substances in articles' posted at this URL: <https://echa.europa.eu/guidance-documents/guidance-on-reach>

Compatible Parts



TE Part # 341299-2
PL 250 REC TERMINAL 20-15 AWG
PTPB



TE Part # 190679-2
POSILOK T*P



TE Part # 2-2150617-2
OCEAN-2.0-APPLICATOR-E-
110F240FA



TE Part # 2150617-2
OCEAN-2.0-APPLICATOR-E-
110F240FA



TE Part # 7-2150617-2
OCEAN-2.0-APPLICATOR-E-
110F240FA



KIT
REPRESENTATION ONLY

TE Part # 7-2150617-7
OCEAN_2.0_SPARE_PART_KIT-
140F240F

Also in the Series | Mark II



Automotive Housings(8)

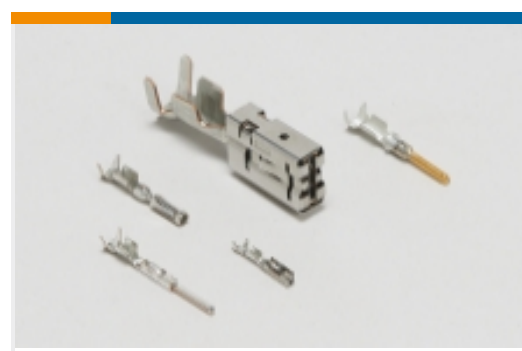

Automotive Terminals(22)



Crimp Terminal Housings(76)



Insertion & Extraction Tools(2)



Quick Disconnects(57)

Also in the Series | Positive Lock 250



Automotive Terminals(1)

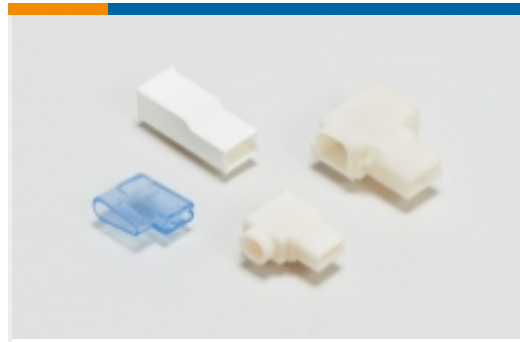

Crimp Terminal Housings(193)



Insertion & Extraction Tools(3)



Insulation Boots & Sleeves(4)



Quick Disconnects(186)

Customers Also Bought



TE Part #2-1241959-4
STD TIM HOUSING MKII 4POS



TE Part #1744416-9
9 POS EP II HSG, GLOW WIRE



TE Part #42400-1
250 FASTON REC 18-14 AWG BR



TE Part #1863011-1
01P UMNL PLUG HSG



TE Part #2-521229-2
PL 250 HOUSING RECEPTACLE RED

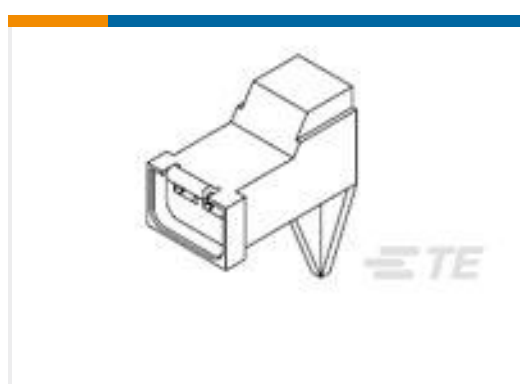

TE Part #521306-1
110 FASTON HSG. REC 5MM2P NATURAL



Documents

Product Drawings

[PL 250 REC 16-18AWG PTBR](#)

English

CAD Files

[3D PDF](#)

3D

Customer View Model

[ENG_CVM_CVM_1742354-1_B.2d_dxf.zip](#)

English

Customer View Model

[ENG_CVM_CVM_1742354-1_B.3d_igs.zip](#)

English

Customer View Model

[ENG_CVM_CVM_1742354-1_B.3d_stp.zip](#)

English

By downloading the CAD file I accept and agree to the [Terms and Conditions](#) of use.

Datasheets & Catalog Pages

[Positive Lock Receptacles](#)

English

Product Specifications

[Application Specification](#)

English

Product Environmental Compliance

[MD_1742354-1_050320161013_dmtec](#)

English

[MD_1742354-1_050320161013_dmtec](#)

English